

INSTRUCTION MANUAL

rotronic
MEASUREMENT SOLUTIONS

PF4 / PF5 Differential Pressure, Humidity and Temperature Transmitter



rotronic
MEASUREMENT SOLUTIONS

Index

1. Introduction	4
2. Overview	4
3. Delivery Package	4
4. Important Information	6
4.1 Preparations	6
4.2 Conditions to Avoid for Installation	6
4.2.1 Wall Mounting	7
4.2.2 Connection of the Differential Pressure Tubes	8
4.3 Electrical Installation	8
5. General Description	9
5.1 PF4/5 Variants and Parameters	9
5.2 Basic Settings / Configuration	9
5.3 Main Features of the PF4/5	9
5.4 Differential Pressure Connections	10
5.5 Terminal Assignment	11
5.6 Cable Grip	11
5.7 Power Supply / Current Consumption	12
6. Parameters	13
6.1 Differential Pressure	13
6.1.1 PF4 with Flow-Based Differential Pressure Sensor	13
6.1.2 PF5 with Diaphragm Differential Pressure Sensor	13
6.1.3 Measurement Ranges	13
6.1.4 Units	13
6.1.5 Smoothing Filter	13
6.1.6 Simulation Value	14
6.1.7 Differential Pressure Adjustment	14
6.1.8 Differential Pressure Adjustment via the Menu	14
6.2 Flow / Volume Flow	15
6.2.1 Calculation of the Flow and Volume Flow	16
6.2.2 Flow Units	16
6.2.3 Volume Flow Units	16
6.2.4 Simulation Value	16
6.3 Humidity (Optional Only with HC2)	17
6.3.1 Measurement Ranges	17
6.3.2 Units	17
6.3.3 Simulation Value	17
6.3.4 Humidity Value Adjustment	17
6.3.5 Humidity Adjustment via the Menu	18
6.4 Temperature (Optional Only with HC2 or Pt100)	18
6.4.1 Measurement Ranges	18
6.4.2 Units	18
6.4.3 Simulation Value	18
6.4.4 Temperature Value Adjustment	19
6.4.5 Temperature Adjustment via the Menu	19
6.5 Psychrometric Calculations (Optional Only with HC2)	20
6.5.1 Possible Psychrometric Calculations	20
6.5.2 Simulation Value	20
6.6 Analog Input	20
6.6.1 Analog Input Scaling	21
6.6.2 Units	23
6.6.3 Simulation Value	23

6.7	Ambient Pressure.....	23
6.7.1	Measurement Ranges.....	23
6.7.2	Units.....	23
6.7.3	Simulation Value.....	23
7.	Additional Features.....	24
7.1	Analog Outputs.....	24
7.1.1	Load at Current Output.....	24
7.1.2	Analog Output Scaling.....	24
7.2	Alarms.....	26
7.2.1	Alarm thresholds.....	26
7.2.2	Alarm Indication.....	27
7.3	Relay.....	27
7.3.1	Relay Alarm.....	27
7.3.2	Relay Settings.....	28
7.4	Digital Interfaces.....	28
7.4.1	Service Interface.....	28
7.4.2	Ethernet (Optional).....	29
7.4.3	RS485 (Optional).....	29
7.5	Modbus Protocol (Optional).....	29
7.6	Rotronic HW4 Software.....	29
8.	PF4/5 Display and Menu.....	30
8.1	Description of the Menu Fields.....	30
8.1.1	Activated Line.....	30
8.1.2	Selection Field.....	30
8.1.3	Data Field.....	30
8.1.4	Action Field.....	30
8.1.5	Function.....	30
8.2	Menu Navigation.....	30
8.3	Main Menus.....	31
8.3.1	Designation of the Variants in the Menu.....	32
8.3.2	Device Information.....	32
8.3.3	Blocked Menu.....	32
8.3.4	Device Settings.....	33
8.3.5	Differential Pressure Settings.....	34
8.3.6	Humidity Settings.....	35
8.3.7	Temperature Settings.....	36
8.3.8	Flow Settings.....	37
8.4	Submenus.....	38
8.4.1	Display Settings.....	38
8.4.2	Analog Input Settings.....	40
8.4.3	Analog Output Settings.....	41
8.4.4	Alarm Settings.....	42
8.4.5	Relay Sources.....	43
8.4.6	Relay Settings.....	45
8.4.7	Calculation Settings.....	46
8.4.8	Communication Settings.....	47
9.	Firmware Update.....	48
10.	Technical Data.....	49
11.	Accessories.....	52
12.	Dimensions.....	53
13.	Additional Documents.....	54
14.	Document Versions.....	54

1. Introduction

Thank you for choosing our PF4/PF5 transmitter. Before using the device, read the instruction manual supplied with it and keep this manual in a safe place for future reference. The device conforms to good engineering practice and relevant safety regulations. To avoid damage, it is assumed that the device is handled in accordance with its intended purpose.

Before you put the device into operation for the first time, please read the chapter Notes in the section Commissioning.

2. Overview

Products from ROTRONIC are characterized by high measurement sensitivity, accuracy and long-term stability. They are therefore ideally suited for monitoring volume flows and pressures in energy-efficient ventilation and air conditioning systems.

Further features:

- ✓ Short response time and low hysteresis
- ✓ Large overload range
- ✓ Freely configurable input and output signals
- ✓ Volt-free semiconductor relay switch contacts
- ✓ Alternative connection for remote HygroClip2 (humidity, temperature or analog signals)
- ✓ Additional protection against unauthorized access by password





3. Delivery Package

Check the delivery package before mounting.

If it does not match your delivery, please contact our customer service:

Telephone: +41 44 838 11 11

E-mail: service@rotronic.ch

Quantity	Name	Illustration						
1	PF4/5 per order code							
1	Factory adjustment certificate	 <table border="1" data-bbox="799 1122 1398 1160"> <thead> <tr> <th>Reference [Pa]</th> <th>UUT [Pa]</th> <th>Error [Pa]</th> </tr> </thead> <tbody> <tr> <td>-24.95</td> <td>-24.95</td> <td>0.04 K₁₀₂</td> </tr> </tbody> </table>	Reference [Pa]	UUT [Pa]	Error [Pa]	-24.95	-24.95	0.04 K ₁₀₂
Reference [Pa]	UUT [Pa]	Error [Pa]						
-24.95	-24.95	0.04 K ₁₀₂						
1	Short instruction manual							
1	Screw set							

4. Important Information

- *Whenever a high level of electromagnetic interference is to be expected, place both the devices and the signal cables as far away as possible from the sources of interference.*



Attention! "Incorrect Measurement"

Use noise filters and surge protectors when heavy machinery or measuring instruments use the same electrical cables. Otherwise falsified measured values are likely.



Attention! "Network Interruption"

Make sure the IP communication is configured correctly before connecting the PF4/PF5 to an active Ethernet network. Otherwise interruptions or conflicts in network communication may occur.

4.1 Preparations

Relative air humidity is dependent on temperature. Correct measurements of relative humidity require that the probe and sensors have exactly the same temperature as the environment being measured.

- *Be aware that the location where you install the probe can have a significant influence on the performance of the device.*

The following preparations guarantee stable performance.

1. Choose a **representative location**. Install the probe where humidity, temperature and pressure conditions are representative of their environment.
2. Ensure **good air flow** at the probe. Air velocities of at least 1 meter/second facilitate adjustment of the sensor to possible temperature and/or humidity fluctuations.
3. Immerse as much as possible of the **probe in the environment** so enough is measured.
4. Prevent **condensation from accumulating** on the sensor wires. Install the probe with the tip facing down. If that is not possible, install the probe horizontally.

4.2 Conditions to Avoid for Installation



Avoid installation:

- *in the immediate vicinity of a heating element, a cooling system, a cold or hot wall, or in direct sunlight.*

- *in the immediate vicinity of a steam injector, humidifier or water source.*
- *in unstable pressure conditions due to air turbulence.*

4.2.1 Wall Mounting

The PF4/PF5 comes with 2 screws, 2 wall plugs and 2 rubber washers. There are 2 screw recesses in the bottom part of the housing (closed on delivery).

1. Use the template supplied to drill the holes in the wall.
2. Drill a suitable hole.
3. Put in the wall plugs.
4. Place a rubber washer under each screw head.
5. Put a screw in each recess.
6. Push through the bottom of the recess.

❖ The device is now installed on the wall.

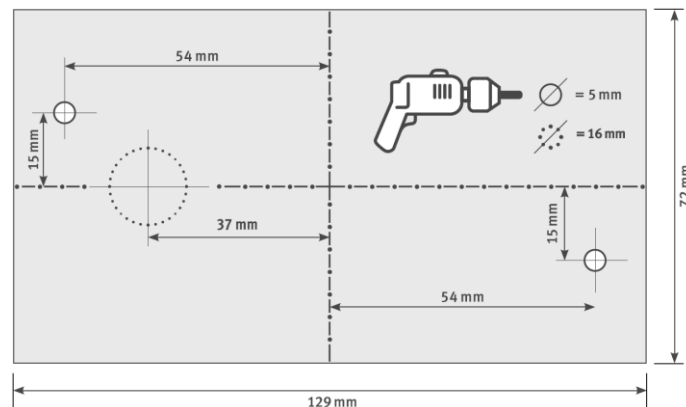

Fig. 1: Drilling template supplied with the package

Alternatively, the PF4/PF5 can also be mounted on a DIN top-hat rail using the AC5002 DIN top-hat rail adapter.



Fig. 2: AC5002 mounting kit for DIN top-hat rails

4.2.2 Connection of the Differential Pressure Tubes

Tubes with an internal diameter of 4 mm (e.g. AC6001) can be connected.

- *The tubes must be fastened securely so that they do not move, vibrate or fall off during operation.*



Fig. 3: Differential pressure connections and E2 socket on the underside of the device

4.3 Electrical Installation

Only qualified personnel may carry out this installation work. No liability will be accepted. Make sure that the grounding cable is longer than the others in the wiring harness so that it can withstand bending best.

The cable must have the following characteristics:

- ✓ Min. voltage: 50 VDC
- ✓ External diameter of 6 to 7 mm (0.236 to 0.275 in)
- ✓ Connection wires according to 18 AWG

The maximum cable length depends on the total resistance, which is the sum of the cable resistance and the resistance of the other devices connected to the unit in series. This should not exceed 500 Ω .



Heavy machinery and measuring instruments should not share the same electric cables for power supply. If this cannot be avoided, noise filters and surge protectors should be used, as integrated in most UPS devices.

5. General Description

5.1 PF4/5 Variants and Parameters

There are three different variants of the PF4/5.

Every PF4/5 variant has pressure connections for tubes with an internal diameter of max. 4 mm.

Each PF4/5 variant offers different parameters:

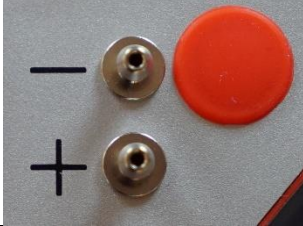
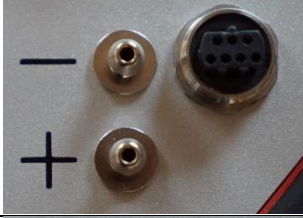
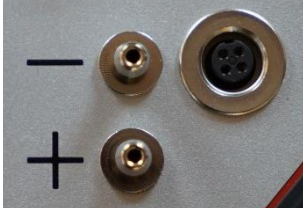
Variant	Connections	Parameters
PF4/5 with differential pressure		Differential pressure Analog input Ambient pressure [Flow] [Volume flow]
PF4/5 with differential pressure and E2 socket for HC2 probe		Differential pressure Relative humidity (HC2) Temperature (HC2) Calculation (HC2) Analog input Ambient pressure [Flow] [Volume flow]
PF4/5 with differential pressure and Binder socket for Pt100 probe		Differential pressure Temperature (Pt100) Analog input Ambient pressure [Flow] [Volume flow]

The parameters **Flow** and **Volume Flow** are only shown if the function [Flow](#) has been selected via the [menu](#), the [Rotronic HW4 software](#) or the [Modbus protocol](#).

5.2 Basic Settings / Configuration

All PF4/5 devices have certain factory-configured functions and connections.

- Analog input
- Ambient pressure sensor
- Relays
- Service interface

5.3 Main Features of the PF4/5

- High-precision measurement and long-term stability
- Short response time and low hysteresis
- Color TFT LCD
- Analog input and output signals freely configurable
- Volt-free relays with switch contacts
- Large overload range
- Flow-based (PF4) or diaphragm differential pressure sensors (PF5)

- Optional connection for HygroClip2 (humidity, temperature) or Pt100 temperature probe (only temperature)
- High immunity to dust and humidity in the medium
- Optionally with Ethernet and Modbus TCP protocol
- Optionally with RS485 interface and Modbus RTU protocol

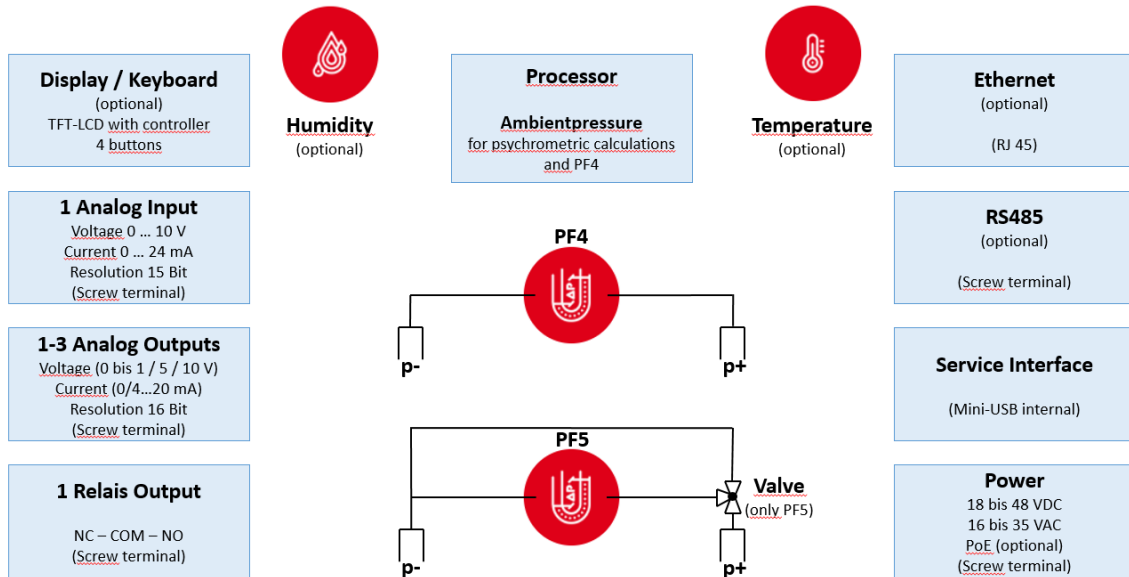

The user can update the firmware to keep the PF4/5 state-of-the-art at all times.

The following diagram shows the function blocks:



5.4 Differential Pressure Connections

Every PF4/5 variant has pressure connections for tubes with an internal diameter of max. 4 mm.

Connection	Description
	Positive pressure connection
	Negative pressure connection

The tubes must be fastened securely so that they do not move, vibrate or fall off during operation.

5.5 Terminal Assignment

The PF4/5 comes with the following terminal connections:

Terminal	Description
V+	Power supply +
V-	Power supply -
OUT3+	Analog output 3+ (optional, depending on device version)
OUT3-	Analog output 3- (optional, depending on device version)
OUT2+	Analog output 2+ (optional, depending on device version)
OUT2-	Analog output 2- (optional, depending on device version)
OUT1+	Analog output 1+
OUT1-	Analog output 1-
IN1+	Analog input 1+
IN1-	Analog input 1-
RXTX+	RS485+ (optional, depending on device version)
RXTX-	RS485- (optional, depending on device version)
S-GND	Signal GND (optional, depending on device version)
NC	Relay contact: Normally Closed (volt-free)
COM	Relay contact: Common (volt-free)
NO	Relay contact: Normally Open (volt-free)

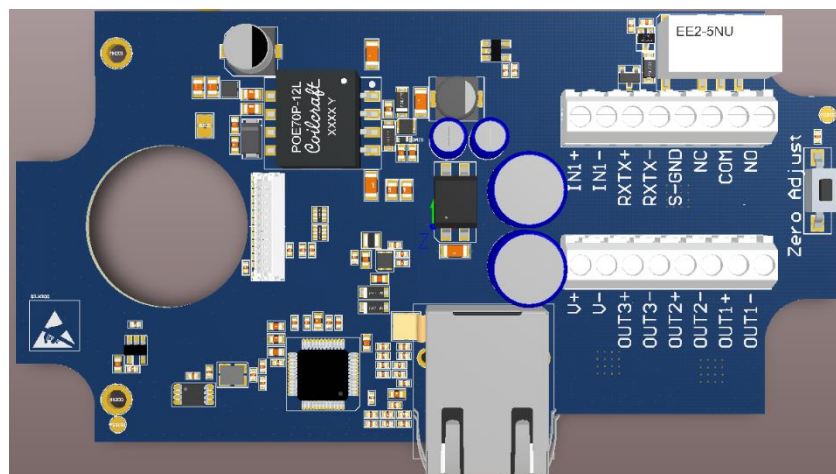

Mainboard with connection terminals

5.6 Cable Grip

The PF4/5 comes with a sealing M16 cable grip with screw cable gland.

Note

- The M16 cable grip only seals effectively if a cable with the necessary number of wires is used.
- If single wires are used, sealing is not guaranteed.

5.7 Power Supply / Current Consumption

The power supply for the PF4/5 is connected via the screw contacts **V+** and **V-** or via the optional Ethernet interface (**P**ower **o**ver **E**thernet).

The power supply is equipped with polarity protection.

Operating Voltage	Current Consumption
18 ... 48 VDC	< 300 mA
16 ... 35 VAC / 50/60Hz	< 300 mA
Power over Ethernet (PoE) 802.3 af, Class 2 (optional, only in devices with Ethernet port)	< 300 mA

Note

- The power supply is galvanically isolated; therefore no wires may be connected to **V+** or **V-**.

6. Parameters

6.1 Differential Pressure

The calibrated and thermally compensated differential pressure sensors used by Rotronic guarantee an exact and stable output signal over a wide temperature range.

Two different types of differential pressure sensor are used.

6.1.1 PF4 with Flow-Based Differential Pressure Sensor

Flow sensors are based on the thermal mass flow measurement of gas through a very small flow duct integrated in the sensor chip.

For the flow sensor, the ambient pressure must be included in the calculation because otherwise the measurement result is not accurate.

6.1.2 PF5 with Diaphragm Differential Pressure Sensor

In the case of the diaphragm sensors, there is no opening between the two pressure connections.

The piezoresistive diaphragm sensor is based on the principle of MEMS. This guarantees high immunity to dust and avoidance of cross contamination between the two spaces in which the pressure is measured.

6.1.3 Measurement Ranges

The following sensor measurement ranges are available:

PF4	PF5
-10 to +10 Pa	-
-25 to +25 Pa	-25 to +25 Pa
-50 to +50 Pa	-50 to +50 Pa
-100 to +100 Pa	-100 to +100 Pa
-250 to +250 Pa	-250 to +250 Pa
-500 to +500 Pa	-500 to +500 Pa

6.1.4 Units

The following unit systems are available for differential pressure:

- Pa (Pascal)
- inH₂O (inch water column)
- mpsi (milli pound-force per square inch)
- mbar (millibar)
- mmHg (millimeter mercury column)
- mmH₂O (millimeter water column)
- Torr (Torr)
- g/cm² (gram per square centimeter)

The unit shown can be set via the [menu](#), the [Rotronic HW4 software](#) or the [Modbus protocol](#).

6.1.5 Smoothing Filter

The differential pressure measured value curve can be smoothed by forming a moving average over the most recent measurements. Up to 10 measurements can be included in the mean value (strongest smoothing), 5 measurements are preset at the factory.

The current measured value is summed up with the N-1 previous measured values and divided by N. The average value is calculated by dividing the measured value by N. If a new measured value is

added, the oldest value of the measured value set falls from the calculation and the new measured value is added.

The smoothing filter can be set via the [menu](#), the [Rotronic HW4 software](#) or the [Modbus protocol](#).

6.1.6 Simulation Value

When the simulation value has been activated, a defined simulation value is used instead of the current differential pressure measured value. This makes it possible to test whether the PF4/5 transmits a defined fictitious measured value to the monitoring system correctly.

The simulation value can only be set, switched on and validated via the [Rotronic HW4 software](#) or the [Modbus protocol](#).

6.1.7 Differential Pressure Adjustment

The differential pressure sensor used in the PF4/5 and the corresponding electronics are extremely stable over the long term. They do not normally need to be changed or recalibrated after factory calibration.

For maximum accuracy, however, we recommend regular calibration of the device and adjustment when necessary.

This can be done via the [Rotronic HW4 software](#), the [Modbus protocol](#) or, with slight restrictions, the menu of the PF4/5.

Caution!

- Adjustments of the differential pressure should only be made with the appropriate knowledge and reference instruments (e.g. CPC2000).
- Changes to the adjustment settings have a direct influence on the differential pressure measurement of the device.
- Since the PF4/5 does not have a real-time clock, the date of the adjustment is not saved. If it is important to record the adjustment date, the [Rotronic HW4 software](#) must be used to adjust the differential pressure.

6.1.8 Differential Pressure Adjustment via the Menu

The following settings can be made to the differential pressure sensor via the [Menu control](#) of the PF4/5 (optional only in PF4/5 with display):

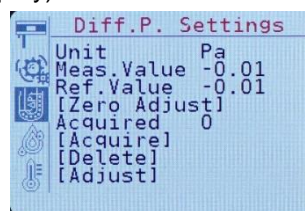

- **Ref.Value** - Recording of a reference value
In this field a current reference value can be entered, then recorded (**[Acquire]**) and adjusted together with reference values already recorded (**[Adjust]**). The current differential pressure is shown in the field **Meas.Value**.
- **[Zero Adjust]** - Zero adjustment of the differential pressure sensor.
After execution of **[Zero Adjust]** the built-in valve (only in PF5) is closed. This connects the two differential pressure inputs of the differential pressure sensor with each other directly (short circuit). The deviation from zero is measured and then taken into account in the calculation of the differential pressure.

Note

- **PF5**

Zero adjustments are only necessary for [differential pressure sensors with diaphragms \(PF5\)](#) because the diaphragms adapt to the prevailing conditions over time and can deform minimally.

Zero adjustment of the PF5 can be carried out automatically.

The corresponding times can only be set via the [Rotronic HW4 software](#) or the [Modbus protocol](#).

- **PF4**

With [flow-based differential pressure sensors](#), a zero adjustment is normally not necessary, but can also be carried out.

It should be noted that for this purpose the two pressure connections are connected with a short piece of tube before zero adjustment is carried out.

- **[Acquire]** - Recording of a previously entered reference value
By pressing **[Acquire]**, the value previously entered in the field **Ref.Value** and the associated values of the device, including ambient pressure, are entered in the table of recorded values. The **Acquired** value counter is increased by 1. A maximum of 31 values can be recorded via the menu.
- **[Delete]** - Deletion of the last reference value recorded
By pressing **[Delete]**, the last recorded reference values are deleted from the table of recorded values. The **Acquired** value counter is reduced by 1.
- **[Adjust]** - Adjustment of the differential pressure sensor
By pressing **[Adjust]**, the values recorded in the table are adjusted. A new lookup table with the adjusted values is generated. The values of the lookup table are applied from this point in time in the calculation of the differential pressure.

Note

- Before performing an adjustment, make sure that there are no "old" reference values in the table of recorded values. **[Delete]** until the number of **Acquired** is **0**.
- The easiest way to record and adjust differential pressure values is to use the [Rotronic HW4 software](#).

6.2 Flow / Volume Flow

The measured values for [Flow and Volume Flow \(Air Flow\)](#) depend directly on the measured differential pressure and are only shown if the function **Flow** has been selected via the [menu](#), the [Rotronic HW4 software](#) or the [Modbus protocol](#).

In order to perform a meaningful flow/volume flow measurement, the appropriate equipment must be available.

- Flow duct
- Flow sensor (blade, suitable for the flow duct)

6.2.1 Calculation of the Flow and Volume Flow

The calculations are carried out using the following formulae:

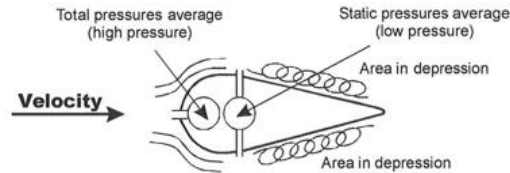

$$\text{Flow} = K_L * \sqrt{\Delta P} \text{ [m/s]}$$

$$\text{Volume Flow (Air Flow)} = K_L * \sqrt{\Delta P} * A * 3600 \text{ [m}^3\text{/h]}$$

K_L Blade Factor ($0 \leq K_L \leq 1.0$)

ΔP Differential Pressure = Total Pressure (Pt) – Static Pressure (Ps)

A Area

Applies to use in air at 20 [°C] (air density = 1.2 [kg/m³])

Possible areas A (flow ducts):

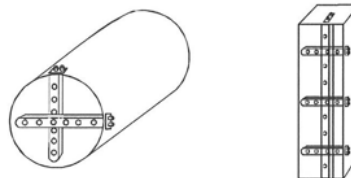

The Blade Factor K_L is a value determined empirically in the range 0 to 1.0 for the blade used.

6.2.2 Flow Units

The following unit systems are available for flow:

- m/s (meters per second)
- km/h (kilometers per hour)
- fps (feet per second)

The unit shown can be set via the [menu](#), the [Rotronic HW4 software](#) or the [Modbus protocol](#).

6.2.3 Volume Flow Units

The following unit systems are available for volume flow:

- m³/h (cubic meters per hour)
- m³/min (cubic meters per minute)
- l/min (liters per minute)
- l/s (liters per second)
- cfm (cubic feet per minute)
- cfs (cubic feet per second)

The unit shown can be set via the [menu](#), the [Rotronic HW4 software](#) or the [Modbus protocol](#).

6.2.4 Simulation Value

When the simulation value has been activated, a defined simulation value is used instead of the current flow/volume flow measured value. This makes it possible to test whether the PF4/5 transmits a defined fictitious measured value to the monitoring system correctly.

The simulation value can only be set, switched on and validated via the [Rotronic HW4 software](#) or the [Modbus protocol](#).

6.3 Humidity (Optional Only with HC2)

The measured value for humidity is only available if a PF4/5 with E2 socket and an inserted humidity/temperature probe (e.g. HC2-S) is used.

6.3.1 Measurement Ranges

The measurement range is 0 to 100 %RH (relative humidity).

6.3.2 Units

Only the unit %RH (relative humidity) is provided for humidity.

It is, however, possible for the user to specify his own unit, e.g. %RH. A user-defined unit can only be set via the [Rotronic HW4 software](#) or Modbus.

The maximum number of digits for the user-defined unit is 5.

6.3.3 Simulation Value

When the simulation value has been activated, a defined simulation value is used instead of the current humidity measured value. This makes it possible to test whether the PF4/5 transmits a defined fictitious measured value to the monitoring system correctly.

The simulation value can only be set, switched on and validated via the [Rotronic HW4 software](#) or the [Modbus protocol](#).

6.3.4 Humidity Value Adjustment

The optional humidity probe used and the corresponding electronics are extremely stable over the long term. They do not normally need to be changed or recalibrated after factory calibration.

For maximum accuracy, however, we recommend regular calibration of the device and adjustment when necessary.

This can be done via the [Rotronic HW4 software](#), the [Modbus protocol](#) or, with slight restrictions, the menu of the PF4/5.

Caution!

- The menu **Humidity Settings** only exists if the device has an HC2 probe.
- Adjustments of the humidity values of the HC2 probe should only be made with the appropriate knowledge and devices (exact humidity reference).
- Changes to the adjustment settings have a direct influence on the humidity measurement of the device.
- Actions in this menu (**[Acquire]**, **[Delete]** and **[Adjust]**) may only be carried out when there is a humidity sensor connected.
- After calling [Adjust], all entries in the table of recorded values are deleted.
- Since the PF4/5 does not have a real-time clock, the date of the adjustment is not written in the HC2 probe. If it is important to record the adjustment date, the [Rotronic HW4 software](#) must be used to adjust the probe.
- The following principle applies to the HC2 probe: temperature adjustment before humidity adjustment!

6.3.5 Humidity Adjustment via the Menu

The following settings can be made to the humidity sensor via the [Menu control](#) of the PF4/5 (optional only in PF4/5 with display):

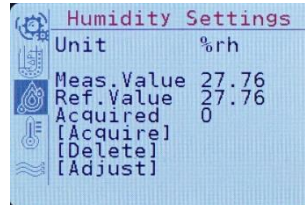

- **Ref.Value** - Recording of a reference value
In this field a current reference value can be entered, then recorded (**[Acquire]**) and adjusted together with reference values already recorded (**[Adjust]**). The current humidity value is shown in the field **Meas.Value**.
- **[Acquire]** - Recording of a previously entered reference value
By pressing **[Acquire]**, the value previously entered in the field **Ref.Value** and the associated values of the device are entered in the table of recorded values. The **Acquired** value counter is increased by 1. A maximum of 100 values can be recorded via the menu.
- **[Delete]** - Deletion of the table of recorded values
By pressing **[Delete]**, all recorded reference values are deleted from the table of recorded values. The **Acquired** value counter is set to **0**.
- **[Adjust]** - Adjustment of the humidity sensor
By pressing **[Adjust]**, the values recorded in the table are adjusted. A new lookup table with the adjusted values is generated. The values of the lookup table are applied from this point in time in the calculation of the humidity.

Note

The easiest way to record and adjust humidity values is to use the [Rotronic HW4 software](#).

6.4 Temperature (Optional Only with HC2 or Pt100)

The measured value for temperature is only available if a PF4/5 with E2 socket and an inserted humidity/temperature probe (e.g. HC2-S) or a PF4/5 with a Binder socket and an inserted Pt100 temperature probe (e.g. AC1900) is used.

6.4.1 Measurement Ranges

Depending on the probe used, the measurement range is minimum -100 [°C] to maximum +200 [°C].

6.4.2 Units

The following unit systems are available for temperature:

- °C (degrees Celsius)
- °F (degrees Fahrenheit)

The unit shown can be set via the [menu](#), the [Rotronic HW4 software](#) or the [Modbus protocol](#).

6.4.3 Simulation Value

When the simulation value has been activated, a defined simulation value is used instead of the current temperature measured value. This makes it possible to test whether the PF4/5 transmits a defined fictitious measured value to the monitoring system correctly.

The simulation value can only be set, switched on and validated via the [Rotronic HW4 software](#) or the [Modbus protocol](#).

6.4.4 Temperature Value Adjustment

The optional temperature probe used and the corresponding electronics are extremely stable over the long term. They do not normally need to be changed or recalibrated after factory calibration.

For maximum accuracy, however, we recommend regular calibration of the device and adjustment when necessary.

This can be done via the [Rotronic HW4 software](#), the [Modbus protocol](#) or the menu of the PF4/5 (optional only in PF4/5 with display).

Caution!

- The menu [Temperature Settings](#) only exists if the device has an HC2 or Pt100 probe.
- Adjustments of the temperature probe should only be made with the appropriate knowledge and devices (exact temperature reference).
- Changes to the adjustment settings have a direct influence on the temperature measurement of the device.
- The action **[Adjust]** may only be carried out when there is an HC2 or Pt100 probe connected.
- Since the PF4/5 does not have a real-time clock, the date of the adjustment is not saved. If it is important to record the adjustment date, the [Rotronic HW4 software](#) must be used to adjust the temperature.
- The following principle applies to the HC2 probe: temperature adjustment before humidity adjustment!

6.4.5 Temperature Adjustment via the Menu

A one-point adjustment of the temperature probe can be carried out via the [Menu control](#) of the PF4/5 (optional only in PF4/5 with display):

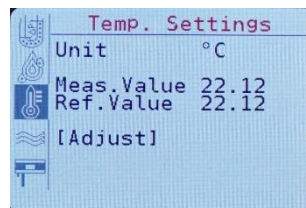

- **Ref.Value** - Recording of a reference value
In this field a current reference value can be entered, which can then be adjusted with the action **[Adjust]**. The current temperature value is shown in the field **Meas.Value**.
- **[Adjust]** - Adjustment of the temperature probe
By pressing **[Adjust]**, the difference between the current value and the reference value is determined and applied as an offset value (one-point adjustment) in the calculation of the temperature.

6.5 Psychrometric Calculations (Optional Only with HC2)

Psychrometric calculations are only available if a PF4/5 with an E2 socket and an inserted humidity/temperature probe (e.g. HC2-S) is used.

6.5.1 Possible Psychrometric Calculations

There are 10 different psychrometric calculations that can be displayed on the PF4/5.

The calculation and unit shown can be set via the [menu](#), the [Rotronic HW4 software](#) or the [Modbus protocol](#).

The abbreviations of the psychrometric calculations are shown on the display if the PF4/5 has a display. For space reasons, only the abbreviation **Ds** is used instead of **Dvs**.

Calculation	Abbreviation	Units
Dew point	Dp	°C (degrees Celsius) °F (degrees Fahrenheit)
Frost point	Fp	°C (degrees Celsius) °F (degrees Fahrenheit)
Wet bulb temperature	Tw	°C (degrees Celsius) °F (degrees Fahrenheit)
Enthalpy	H	kJ/kg (kilojoule per kilogram) BTU/lb (British thermal unit per pound)
Vapor concentration	Dv	g/m ³ (gram per cubic meter) gr/ft ³ (gram per cubic feet)
Specific humidity	Q	g/kg (gram per kilogram) gr/lb (gram per pound)
Mixing ratio	R	g/kg (gram per kilogram) gr/lb (gram per pound)
Saturation vapor concentration	Dvs (Ds)	g/m ³ (gram per cubic meter) gr/ft ³ (gram per cubic feet)
Vapor partial pressure	E	hPa (hectopascal) inHg (inch column of mercury) psi (pound-force per square inch)
Vapor saturation pressure	Ew	hPa (hectopascal) inHg (inch column of mercury) psi (pound-force per square inch)

6.5.2 Simulation Value

When the simulation value has been activated, a defined simulation value is used instead of the current calculated psychrometric value. This makes it possible to test whether the PF4/5 transmits a defined fictitious measured value to the monitoring system correctly.

The simulation value can only be set, switched on and validated via the [Rotronic HW4 software](#) or the [Modbus protocol](#).

6.6 Analog Input

The PF4/5 provides an analog input (IN1+ / IN1-).

The analog input can be switched between voltage measurement and current measurement via the [menu](#), the [Rotronic HW4 software](#) or the [Modbus protocol](#).

A signal amplitude of 0 to 10.0 [V] can be measured for voltage measurement. The internal resistance is greater than 50 [kΩ].

A measurement resistance of approx. 412.5 [Ω] is used for current measurement. This results in a current measurement range from 0 to 24.0 [mA]. The current measurement range is factory-set to maximum accuracy.

If the PF4/5 has a display, the abbreviation for the analog input is shown as **An** on the display.

6.6.1 Analog Input Scaling

The analog input is freely scalable.

The following example shows the setting options for the analog input.

Calculation of the display value:

The display value is calculated from the settings for the **Input Range** and **Processing Range**:

$$\text{Displayed Value} = \frac{(\text{ADC Value} - \text{Range Low}) * (\text{Scale High} - \text{Scale Low})}{(\text{Range High} - \text{Range Low})} + \text{Scale Low}$$

Note

- **Range High** must be set greater than **Range Low**.
- **Scale High** must be set unequal to **Scale Low**.
- The scale can only be set via the [Rotronic HW4 software](#) or the [Modbus protocol](#).

Example with unchanged input range:

The specified input range (**0.0** to **10.0 [V]** for voltage measurement or **0.0** to **24.0 [mA]** for current measurement) can be shown on the display with a scale specified by the user, e.g. **-25.0** to **100.0** and a unit selected by the user, e.g. **[°C]**.

Note

- The unit **[°C]** can only be set via the [Rotronic HW4 software](#) or the [Modbus protocol](#).

Calculation:

A voltage signal of **2.5 [V]** within the **Input Range** of **0** to **10 [V]** is adapted to the **Processing Range** of **-25 [°C]** to **+100 [°C]**.

$$\text{Displayed Value} = \frac{(2.5 - 0) * (100 - -25)}{(10 - 0)} + -25 = 6.25$$

A measured value of **2.5 [V]** thus results in a displayed value of **6.25 [°C]**.

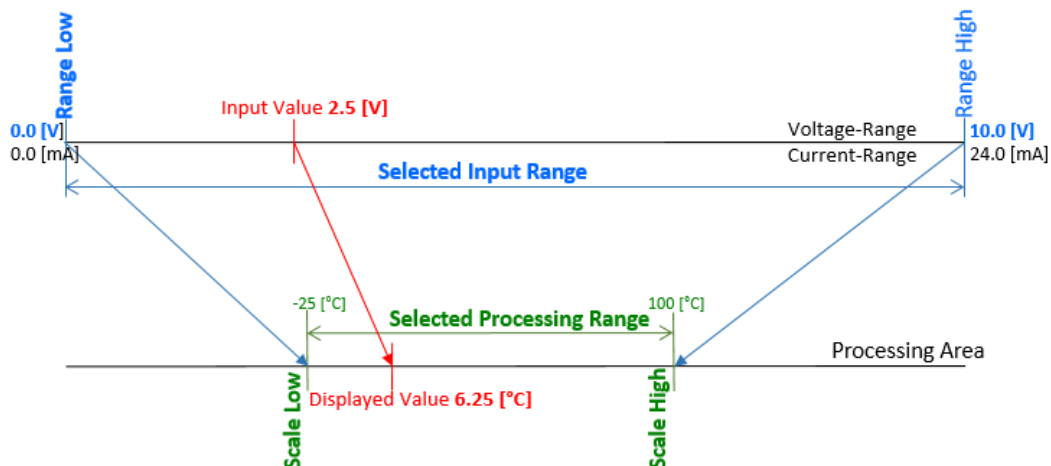

Example with variable input range:

A special input range can be monitored, e.g. from **3.0 [mA]** to **18 [mA]**, by changing the two limit values within the permitted range. This input range can be shown on the display with a user-defined scale, e.g. **800** to **2,000** and unit, e.g. **[ppm]**.

Note

- The user-defined unit, e.g. **[°ppm]** can only be set via the [Rotronic HW4 software](#) or the [Modbus protocol](#).

Calculation:

A current signal of **7.6 [mA]** within the **Input Range** of **3 to 18 [mA]** (permitted range 0 to 24 [mA]) is adapted to the **Processing Range** of **800 [ppm]** to **2000 [ppm]**.

$$\text{Displayed Value} = \frac{(7.6 - 3) * (2000 - 800)}{(18 - 3)} + 800 = 1168$$

An input value of **7.6 [mA]** thus results in a displayed value of **1,168 [ppm]**.

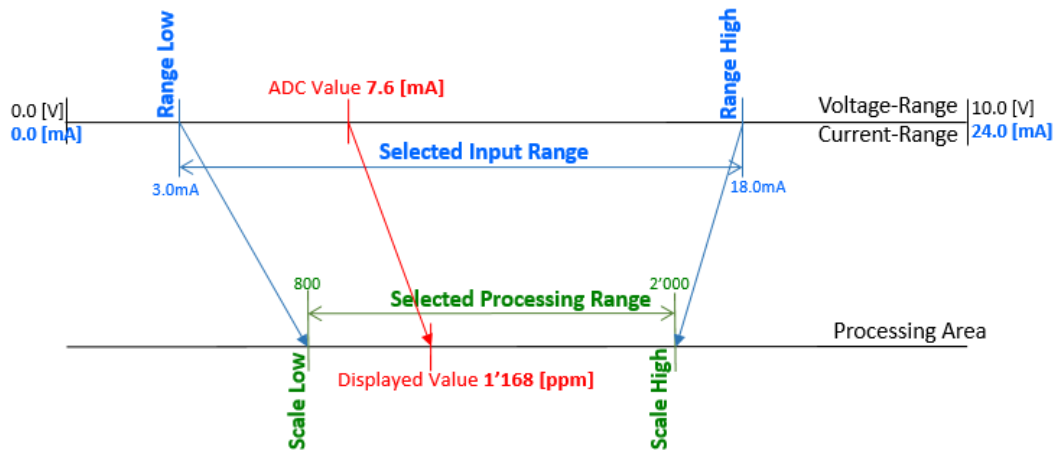

A special input range can be monitored, e.g. from 1200 mV to 7500 mV by changing the two input values within the permitted range. This input range can be shown on the display with a user-defined scale, e.g. 400 to 4,000 and unit, e.g. [ppm]. An input value of 1800 mV thus results in a displayed value of 742.9 [ppm].

Customer Settings		Result Table											
Input	Result	Input	Value	Input	Value	Input	Value	Input	Value	Input	Value	Input	Value
Range Lo	1200	0	-285.7	2000	857.1	4000	2000.0	6000	3142.9	8000	4285.7		
Range Hi	7500	100	-228.6	2100	914.3	4100	2057.1	6100	3200.0	8100	4342.9		
Scale Lo	400	200	-171.4	2200	971.4	4200	2114.3	6200	3257.1	8200	4400.0		
Scale Hi	4000	300	-114.3	2300	1028.6	4300	2171.4	6300	3314.3	8300	4457.1		
Change Range/Scale		400	-57.1	2400	1085.7	4400	2228.6	6400	3371.4	8400	4514.3		
		500	0.0	2500	1142.9	4500	2285.7	6500	3428.6	8500	4571.4		
		600	57.1	2600	1200.0	4600	2342.9	6600	3485.7	8600	4628.6		
		700	114.3	2700	1257.1	4700	2400.0	6700	3542.9	8700	4685.7		
		800	171.4	2800	1314.3	4800	2457.1	6800	3600.0	8800	4742.9		
		900	228.6	2900	1371.4	4900	2514.3	6900	3657.1	8900	4800.0		
		1000	285.7	3000	1428.6	5000	2571.4	7000	3714.3	9000	4857.1		
		1100	342.9	3100	1485.7	5100	2628.6	7100	3771.4	9100	4914.3		
		1200	400.0	3200	1542.9	5200	2685.7	7200	3828.6	9200	4971.4		
		1300	457.1	3300	1600.0	5300	2742.9	7300	3885.7	9300	5028.6		
		1400	514.3	3400	1657.1	5400	2800.0	7400	3942.9	9400	5085.7		
		1500	571.4	3500	1714.3	5500	2857.1	7500	4000.0	9500	5142.9		
		1600	628.6	3600	1771.4	5600	2914.3	7600	4057.1	9600	5200.0		
		1700	685.7	3700	1828.6	5700	2971.4	7700	4114.3	9700	5257.1		
		1800	742.9	3800	1885.7	5800	3028.6	7800	4171.4	9800	5314.3		
		1900	800.0	3900	1942.9	5900	3085.7	7900	4228.6	9900	5371.4		
										10000	5428.6		

6.6.2 Units

The unit for the analog input can be determined by the user and set via the [Rotronic HW4 software](#) or the [Modbus protocol](#).

If the user does not select a unit of his own, a basic unit is displayed in [V] or [mA] depending on the selection of the measurement signal (voltage or current measurement) of the analog input.

The basic unit is only displayed if the field **Auto Unit** is activated.

Auto Unit	Unit Customer	Unit
Off	(empty)	(empty)
On	(empty)	V / mA
Off	ppm	ppm
On	ppm	ppm

The field **Auto Unit** can be set via the [menu](#), the [Rotronic HW4 software](#) or the [Modbus protocol](#).

Note

- The user-defined unit, e.g. [°ppm] can only be set via the [Rotronic HW4 software](#) or the [Modbus protocol](#).

6.6.3 Simulation Value

When the simulation value has been activated, a defined simulation value is used instead of the current analog input measured value. This makes it possible to test whether the PF4/5 transmits a defined fictitious measured value to the monitoring system correctly.

The simulation value can only be set, switched on and validated via the [Rotronic HW4 software](#) or the [Modbus protocol](#).

6.7 Ambient Pressure

The calibrated and thermally compensated ambient pressure sensor used by Rotronic allows the use of flow-based differential pressure sensors and the accurate calculation of psychrometric parameters that require the ambient pressure.

6.7.1 Measurement Ranges

The measurement range is 900 to 1100 [hPa].

6.7.2 Units

- hPa (hectopascal)
- inHg (inch column of mercury)
- psi (pound-force per square inch)

The unit shown can be set via the [menu](#) (only PF4/5 with HC2 probe), the [Rotronic HW4 software](#) or the [Modbus protocol](#).

6.7.3 Simulation Value

When the simulation value has been activated, a defined simulation value is used instead of the current ambient pressure measured value. This makes it possible to test whether the PF4/5 transmits a defined fictitious measured value to the monitoring system correctly.

The simulation value can only be set, switched on and validated via the [Rotronic HW4 software](#) or the [Modbus protocol](#).

7. Additional Features

7.1 Analog Outputs

Depending on the device version, the PF4/5 has a maximum of three analog outputs (OUT1+ / OUT1-, OUT2+ / OUT2-, OUT3+ / OUT3-).

Each analog output can be assigned the various device-dependent measured values as well as one of five possible output ranges.

The following output ranges are available:

Type	Output Ranges
Voltage	0 to 1 V
	0 to 5 V
	0 to 10 V
Current	0 to 20 mA
	4 to 20 mA

7.1.1 Load at Current Output

If a current output is selected, the connected load must be compensated. A maximum load of 500 Ω and a minimum load of 0 Ω is allowed.

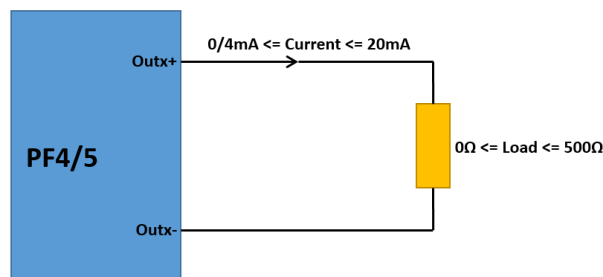

Note

- When the device is delivered, a load of 250Ω is set internally. In this case, a load of 250Ω must be installed so that the output signal is not falsified.
- The load can only be set via the [Rotronic HW4 software](#) or the [Modbus protocol](#).

7.1.2 Analog Output Scaling

The measured values are freely scalable.

The assignment of the various measured values and output ranges to the analog outputs can be carried out via the [menu](#), the [Rotronic HW4 software](#) or the [Modbus protocol](#).

Calculation of the output value

The output range of the analog output (**Output Range**, **Range High** and **Range Low**) always covers the complete selected range, depending on the voltage or output range.

The output value is calculated from the settings for the measurement range (**Measured Range**, **Scale High** and **Scale Low**) and output range:

$$\text{Output Value} = \frac{(\text{Measured Value} - \text{Scale Low}) * (\text{Range High} - \text{Range Low})}{(\text{Scale High} - \text{Scale Low})} + \text{Range Low}$$

Note

- The range limits of the selected output range cannot be altered.
- **Scale High** must be set greater than **Scale Low**.
- The scale can only be set via the [Rotronic HW4 software](#) or the [Modbus protocol](#).

Example with output range 0 to 10 [V]:

A differential pressure of **-5 [Pa]** of the **Measured Range** of **-25 [Pa]** to **+25 [Pa]** is adapted to the **Output Range** of **0 to 10 [V]**.

$$\text{Output Value} = \frac{(-5 - -25) * (10 - 0)}{(25 - -25)} + 0 = 4.0 \text{ [V]}$$

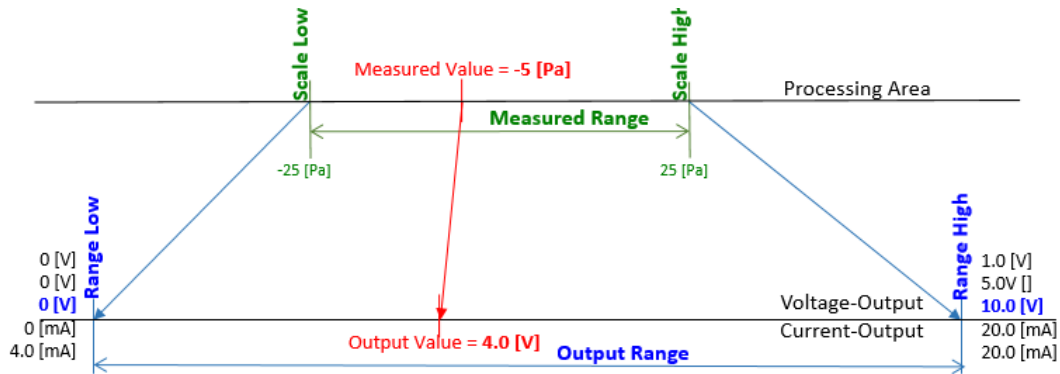

Example with output range 4 to 20 [mA]:

A humidity value of **39.5 [%RH]** of the **Measured Range** of **0 [%RH]** to **100 [%RH]** is adapted to the **Output Range** of **4.0 to 20 [mA]**.

$$\text{Output Value} = \frac{(39.5 - 0) * (20 - 4)}{(100 - 0)} + 4 = 10.32 \text{ [mA]}$$

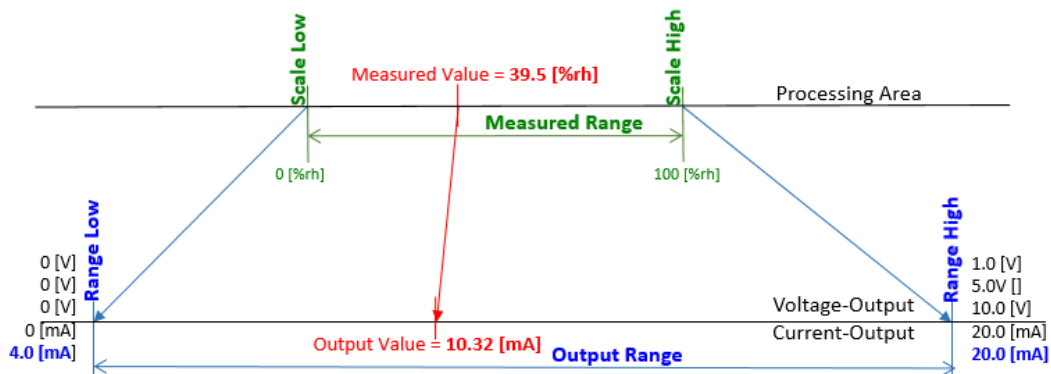

The values for the output range depend on the setting of the analog output and cannot be altered. By changing the two end values of the measured range, the input range can be restricted to the parameter selected by the user with corresponding values, e.g. to the measured ranges of -100 [Pa] to 250 [Pa] for the differential pressure. A measurement signal of 40 [Pa] thus results in an output signal of 4000 mV for an output range of 0 to 10 V.

		Result Table									
		Measured	Output	Measured	Output	Measured	Output	Measured	Output	Measured	Output
Scale Low	-100	-1000	not valid	-500	not valid	0	2857.1	500	not valid	1000	not valid
Scale High	250	-975	not valid	-475	not valid	25	3571.4	525	not valid	1025	not valid
Range Low	0	-950	not valid	-450	not valid	50	4285.7	550	not valid	1050	not valid
Range High	10000	-925	not valid	-425	not valid	75	5000.0	575	not valid	1075	not valid
Change Range/Scale		-900	not valid	-400	not valid	100	5714.3	600	not valid	1100	not valid
		-875	not valid	-375	not valid	125	6428.6	625	not valid	1125	not valid
		-850	not valid	-350	not valid	150	7142.9	650	not valid	1150	not valid
		-825	not valid	-325	not valid	175	7857.1	675	not valid	1175	not valid
		-800	not valid	-300	not valid	200	8571.4	700	not valid	1200	not valid
Measured	Output	-775	not valid	-275	not valid	225	9285.7	725	not valid	1225	not valid
50	4285.7	-750	not valid	-250	not valid	250	10000.0	750	not valid	1250	not valid
Change Measured		-725	not valid	-225	not valid	275	not valid	775	not valid	1275	not valid
		-700	not valid	-200	not valid	300	not valid	800	not valid	1300	not valid
		-675	not valid	-175	not valid	325	not valid	825	not valid	1325	not valid
		-650	not valid	-150	not valid	350	not valid	850	not valid	1350	not valid
		-625	not valid	-125	not valid	375	not valid	875	not valid	1375	not valid
		-600	not valid	-100	0.0	400	not valid	900	not valid	1400	not valid
		-575	not valid	-75	714.3	425	not valid	925	not valid	1425	not valid
		-550	not valid	-50	1428.6	450	not valid	950	not valid	1450	not valid
		-525	not valid	-25	2142.9	475	not valid	975	not valid	1475	not valid

7.2 Alarms

The PF4/5 has adjustable alarm values for all parameters of the respective device variant, except for ambient pressure.

The alarms for the various parameters can be switched off or on globally (**Off / On**). The global alarms can be switched on or off via the [menu](#), the [Rotronic HW4 software](#) or the [Modbus protocol](#).

In the factory setting, all alarms are switched off (**Off**).

7.2.1 Alarm thresholds

There are the following alarm thresholds for the various parameters:

- **Alarm Low**
Lower alarm threshold below which an alarm can be shown on the display and a relay alarm triggered.
- **Pre Alarm Low**
Lower pre-alarm threshold below which a pre-alarm can be shown on the display. The lower pre-alarm threshold is normally higher than the lower alarm threshold.
- **Pre Alarm High**
Upper pre-alarm threshold above which a pre-alarm can be shown on the display. The upper pre-alarm threshold is normally lower than the upper alarm threshold.
- **Alarm High**
Upper alarm threshold above which an alarm can be shown on the display and a relay alarm triggered.
- **Hysteresis**
If a set alarm threshold is exceeded or fallen below, the alarm is activated. The activated alarm is only reset if the current measured value falls below the upper alarm threshold by the value of the set hysteresis or exceeds the lower alarm threshold by the value of the set hysteresis.

The hysteresis does not apply to the pre-alarms.

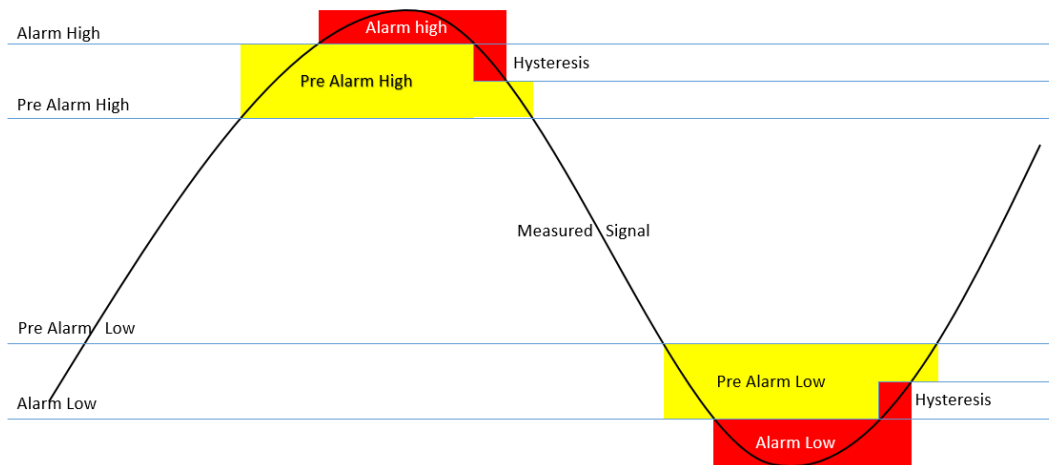

Note

- The pre-alarm and alarm thresholds can only be set via the [Rotronic HW4 software](#) or the [Modbus protocol](#).

7.2.2 Alarm Indication

Every alarm is shown on the display (optional only in PF4/5 with display). If the [global alarm](#) for the corresponding parameter is activated (**On**), the alarm can be output to the [relay](#).

The color of the alarm display can be defined by the user (default setting: **red**).

Every pre-alarm is shown on the display.

The color of the pre-alarm display can be defined by the user (default setting: **yellow**).

Note

- The colors for the alarms can only be set via the [Rotronic HW4 software](#) or the [Modbus protocol](#).

7.3 Relay

The PF4/5 contains a volt-free relay with changeover contact NO (Normally Open), COM (Common), NC (Normally Closed).

The relay can be activated via freely configurable low/high alarms for all parameters of the respective device variant, except for ambient pressure.

7.3.1 Relay Alarm

The alarm release can be set individually for every parameter, except for ambient pressure.

An active alarm can be routed to the built-in relay.

All alarms of the PF4/5 are OR-linked. Alarms of different parameters can therefore activate the relay.

The following relay alarms are possible if the global alarm for the corresponding parameter is activated (**On**):

- **Off**
The relay is never activated.
- **Low**
The relay is activated if the lower alarm threshold of the parameter is not reached.
- **High**
The relay is activated if the upper alarm threshold of the parameter is exceeded.
- **Hi/Lo**
The relay is activated if the lower alarm threshold of the parameter is not reached or the upper alarm threshold of the parameter is exceeded.

The alarm trigger can be set via the [menu](#), the [Rotronic HW4 software](#) or the [Modbus protocol](#).

7.3.2 Relay Settings

The following [relay parameters](#) can also be set:

- **On Delay**
The relay is only switched on when an alarm endures for a certain minimum time.
- **On Time**
The relay stays on for at most the time set.
- **Alarm Off**
 - **No End**

Caution!

 - The alarm stays active until the device is restarted!
 - This can only be achieved by a forced reset, e.g. by pressing the Enter key (✓) for 10 seconds or by interrupting the power supply.
 - **End Alarm**
The alarm stays active until the alarm state is terminated.
 - **End Time**
The alarm stays active until the maximum On Time set has elapsed.
 - **End Alarm or Time**
The alarm stays active until either the alarm state is terminated or the maximum On Time set has elapsed.
- **Relay Muting**
If **Relay Muting** is activated, an active alarm can be muted.
- **Mute Time**
Time in which an active relay alarm is muted.
Pressing the **Enter key** (✓) during an active relay alarm mutes the relay and deactivates it during the time set in **Mute Time**. After the **Mute Time** has elapsed, the relay is reactivated if a relay alarm is still active.

The relay settings can be set via the [menu](#), the [Rotronic HW4 software](#) or the [Modbus protocol](#).

7.4 Digital Interfaces

Every PF4/5 version has the Rotronic-specific [service interface](#) as communication channel. In addition, optional communication channels can be connected via [Ethernet](#) and [RS485](#).

7.4.1 Service Interface

The service interface is used to connect a computer running the [Rotronic HW4 software](#) using an optionally available AC3006/AC3009 connection cable. It can then be used to make device settings and update the firmware.

Note

- The service interface (Mini-USB port) is intended for servicing the device by appropriately trained staff.
- The service interface can only be accessed after the PF4/5 housing has been opened.
- The PF4/5 can be powered via the service interface. In this case, however, the valves for zeroing (PF5 only) and the analog outputs are not active.
- For sensor adjustment and operation of the analog outputs, the PF4/5 must be supplied with power from a suitable power source (V+ / V- or PoE).

7.4.2 Ethernet (Optional)

The PF4/5 is optionally available with an Ethernet port.

In this case the PF4/5 can be powered via Power over Ethernet (PoE) if desired.

A computer running the [Rotronic HW4 software](#) can be connected to the Ethernet port. It can then be used to make device settings and update the firmware.

It is also possible to make all settings for the PF4/5 using the [Modbus protocol](#) (Modbus TCP).

7.4.2.1 Fixed IP Address / DHCP

It is possible to adjust the default IP address via the PF4/5 menu [Communication Settings](#), the [Rotronic HW4 software](#) or the [Modbus protocol](#).

The user can set a fixed IP address for the Ethernet port of the PF4/5.

It is also possible to assign an IP address to the PF4/5 via DHCP.

The choice between fixed IP address and DHCP can be made via [the menu](#), the [Rotronic HW4 software](#) or the Modbus protocol. Likewise input of the fixed IP address.

Note

- A fixed IP address of 192.168.1.1 is factory-set for every PF4/5 with Ethernet option.

7.4.3 RS485 (Optional)

The PF4/5 is optionally available with an RS485 interface with adjustable [device number](#).

A computer running the [Rotronic HW4 software](#) can be connected to the RS485 interface. It can then be used to make device settings and update the firmware.

It is also possible to make all settings for the PF4/5 via the RS485 interface using the [Modbus protocol](#) (Modbus RTU).

Note

- The device number for every PF4/5 with RS485 is factory-set to 0.

7.5 Modbus Protocol (Optional)

The PF4/5 supports the [Modbus protocol](#).

All settings for PF4/5 devices equipped with the optionally available Ethernet or RS485 interface can be made via the [Modbus protocol](#).

The PF4/5 with Ethernet supports the Modbus TCP protocol, the PF4/5 with RS485 interface the Modbus RTU protocol.

There is a detailed [Modbus document](#) available in this regard.

7.6 Rotronic HW4 Software

The Rotronic HW4 software is a monitoring and control software for almost all Rotronic devices. The PF4/5 is supported as of HW4 V3.8.

8. PF4/5 Display and Menu

All PF4/5 with the optional color display can perform a variety of functions via the integrated menu.

8.1 Description of the Menu Fields

8.1.1 Activated Line

An activated line is the currently selected line, highlighted in black, within a menu.

8.1.2 Selection Field

Selection fields are fields in which the appropriate value can be selected from a predefined list.

The content of the list can depend on the version or the configuration standard (e.g. number of DAC modules) of the device.

8.1.3 Data Field

Data fields are fields whose contents can be altered.

There are integer and float data fields, with and without sign.

Within a data field, the selected field can be altered with all keys ([Menu Navigation](#)).

8.1.4 Action Field

Action fields are fields whose activation (pressing the Enter key (✓) immediately triggers an action.

Note

- Some actions automatically trigger a restart of the device at the end of the action.



8.1.5 Function



A function has a direct effect on the device and is activated by pressing and holding a key.

8.1.5.1 Restart

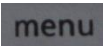
Pressing the Enter key (✓) for longer than approx. 10 seconds restarts the device.

8.2 Menu Navigation

Button	Action(s)
	<ul style="list-style-type: none"> • Selection of the menu • Exiting the menu • Return from the submenu ([More Settings]) to the main menu <p>Data field:</p> <ul style="list-style-type: none"> • Cursor to the left in a data field. If the cursor is on the far left, leaving of the data field without saving the data field contents.
 (Enter key)	<p>Selection field:</p> <ul style="list-style-type: none"> • Selection of a line within the menu • Activation of the data field belonging to the line • Leaving of an activated line with saving of the selection • Activation of the selection of a data field • Activation of a menu action



	<p>Data field:</p> <ul style="list-style-type: none"> • Activation of a data field within the menu • Cursor to the right within the data field If the cursor is on the far right, leaving of the data field with saving of the data field contents. <p>Action field: An action field is framed by square brackets, e.g. [Zero Adjust].</p> <ul style="list-style-type: none"> • 1. Press Enter – selection of the action (action field is selected) • 2. Press Enter –starting of the action <p>The actions are executed directly. Some actions can trigger a restart of the device.</p> <p>Function: Pressing the Enter key (✓) for longer than approx. 10 seconds restarts the device (Reset).</p>
	<p>Activated line:</p> <ul style="list-style-type: none"> • The next executable line is selected <p>Selection field:</p> <ul style="list-style-type: none"> • The next selection of the field is shown <p>Data field:</p> <ul style="list-style-type: none"> • The selected digit is incremented. The limits of the data field are shown in the bottom line. These limits cannot be exceeded.
	<p>Activated line:</p> <ul style="list-style-type: none"> • The previously executable line is selected <p>Selection field:</p> <ul style="list-style-type: none"> • The previous selection of the field is shown <p>Data field:</p> <ul style="list-style-type: none"> • The selected digit is decremented. The limits of the data field are shown in the bottom line. These limits cannot be exceeded.

8.3 Main Menu

Caution!

- As soon as the menu of the PF4/5 is activated via keyboard, no new sensor data is read and the activated analog outputs remain at the last sensor value read until the menu of the PF4/5 is exited again.
- If current calibration values are required in a menu item, the most current sensor data are always read in, displayed and used.



8.3.1 Designation of the Variants in the Menu

Designation	Icon	menu
PF4/5 only with pressure connections		PF4/5
PF4/5 with differential pressure and E2 socket for HC2		PF4/5 + HC2
PF4/5 with differential pressure and Binder socket for Pt100		PF4/5 + Pt100

8.3.2 Device Information

The menu **Device Information** contains information on the device and respective equipment of the device.

The data in the menu **Device Information** cannot be altered.

PF4/5	PF4/5 + Pt100	PF4/5 + HC2
		
<pre> Device Information Firmware V1.0-1 Serial/N 0000000001 Device/N 0 Ethernet DHCP Off 192.168.001.001 </pre>	<pre> Device Information Firmware V1.0-1 Serial/N 0000000001 Device/N 0 Ethernet DHCP Off 192.168.001.001 Pt100-Probe </pre>	<pre> Device Information Firmware V1.0-1 Serial/N 0000000001 Device/N 0 Ethernet DHCP Off 192.168.001.001 HC2-FW V1.5-1 HC2-S/N 0060389215 </pre>

Menu description

Line	Designation	Value	Description	Variants
1	Firmware	V1.0-1	Firmware version (PF4/5)	All variants
2	Serial/N	0000000001	Serial number (PF4/5)	
3	Device/N	Not used	Device number corresponds to the RS485 network address of the device	
		0		
4	Ethernet	Not used	Ethernet not used	
		DHCP Off	DHCP not used	
		DHCP On	DHCP used	
5			Empty line if Ethernet not used	
	192.168.001.001		DHCP Off: Fixed IP address	
	010.065.100.151		DHCP On: IP address assigned by DHCP server	
6			Empty line	
7			Empty line	PF4/5
	Pt100-Probe		Designation	PF4/5 + Pt100
	HC2-FW	V1.5-1	Firmware version (HC2)	PF4/5 + HC2
8			Empty line	PF4/5
			Empty line	PF4/5 + Pt100
	HC2-S/N	0060389215	Serial number (HC2)	PF4/5 + HC2

8.3.3 Blocked Menu

If the menu has been blocked, only the main menu "**Device Information**" can be shown. Access to the other menus is blocked until a valid 4-digit code is entered.

If the code entered is valid, the remaining menus will be enabled.

After entering the valid code, select the field [Open Menu] and press the Enter key (✓).

The enabled time of the menus is approx. 100 seconds and is reactivated each time a key is pressed. At the end of the enabled time, the menu is blocked again.

Note

- Menu blocking can only be activated via the [Rotronic HW4 software](#) or the [Modbus protocol](#).
- Menu blocking is not activated in delivery state.

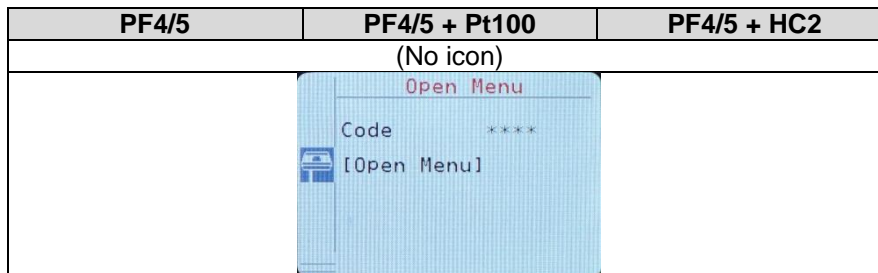

Menu description

Line	Designation	Value	Description
1			Empty line
2	Code	****	Data field: 4-digit code
3			Empty line
4	[Open Menu]		Action field: Open the menu by pressing the Enter key (✓)
5...8			Empty lines

8.3.4 Device Settings

The menu **Device Settings** presents submenus and allows adjustments to the first settings for the differential pressure.

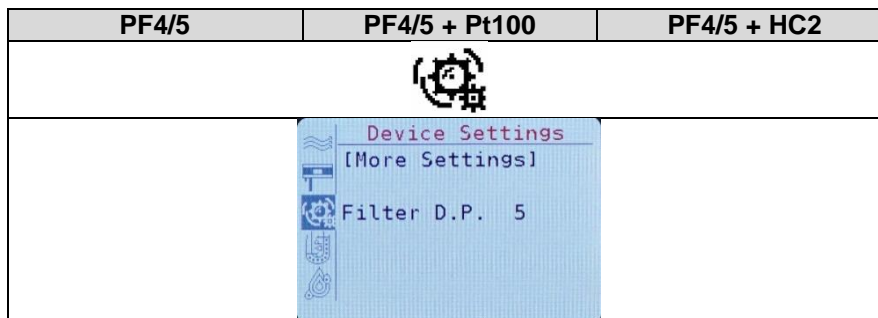

Menu description

Line	Designation	Value	Description
1	[More Settings]		Action field: Call up the submenu
2			Empty line
3			Empty line
4	Filter D.P.	5	Data field: Smoothing filter , filter value for smoothing the measurement of the differential pressure (0 ≙ quick adjustment without filtering, 10 ≙ slow adjustment over 10 averages)
5...8			Empty lines

8.3.5 Differential Pressure Settings

The menu **Differential Pressure Settings** allows adjustments to the settings for the [differential pressure](#).

Caution!

- [Adjustments of the differential pressure](#) should only be made with the appropriate knowledge and reference instruments (e.g. CPC2000).
- Changes to the adjustment settings have a direct influence on the differential pressure measurement of the device.

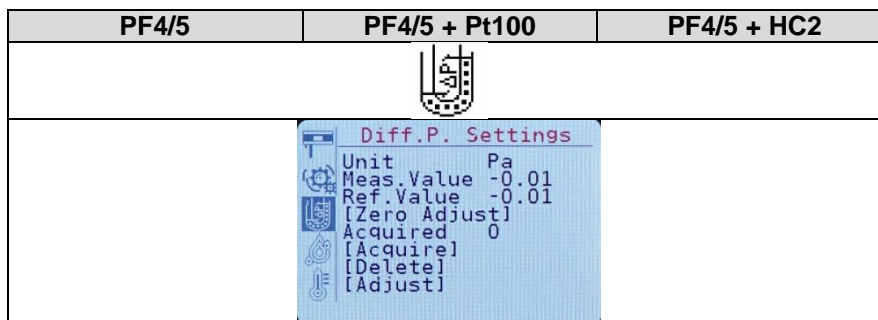

Menu description

Line	Designation	Value	Description
1	Unit	Pa inH2O mpsi mbar mmHg mmH2O Torr g/cm2	Selection field: Unit for the differential pressure
2	Meas. Value	0.27	Current differential pressure. This value is used for comparison, and cannot be altered.
3	Ref. Value	0.27	Data field: Current differential pressure. This value can be adjusted and serves as reference pressure value for possible inclusion in the table of recorded values.
4	[Zero Adjust]		Action field: Call zero adjustment for the differential-pressure sensor. <i>After calling up this action, the device must be restarted. This is done automatically.</i>
5	Acquired	0	Shows the number of recorded values in the table of recorded values. This value cannot be altered.
6	[Acquire]		Action field: Record a reference value and the current measured values belonging to it for differential pressure and ambient pressure. All values are stored in the table of recorded values. A maximum of 31 reference values can be recorded.
7	[Delete]		Action field: Delete the recorded data values. The last reference value entered and its associated values are deleted from the table of recorded values.
8	[Adjust]		Action field: Adjust the recorded values and generate a new customer lookup table. <i>After calling up this action, the device must be restarted. This is done automatically.</i>

8.3.6 Humidity Settings

The menu **Humidity Settings** allows adjustments to the settings for the humidity (HC2 probe).

Caution!

- The menu **Humidity Settings** only exists if the device has an HC2 probe.
- Adjustments of the humidity values of the HC2 probe should only be made with the appropriate knowledge and devices (exact humidity reference).
- Changes to the adjustment settings have a direct influence on the humidity measurement of the device.
- Actions in this menu (**[Acquire]**, **[Delete]** and **[Adjust]**) may only be carried out when there is a humidity sensor connected because all actions are stored in the humidity probe.

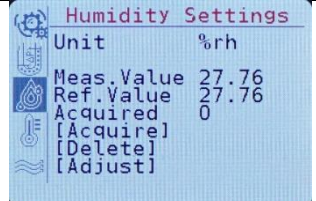
PF4/5	PF4/5 + Pt100	PF4/5 + HC2
		
		

Menu description

Line	Designation	Value	Description
1	Unit	%RH xxxxx	Unit for relative humidity % RH (Rotronic standard). It is possible for the user to define an own humidity unit .
2			Empty line
3	Meas.Value	35.67	Current humidity value. This value is used for comparison, and cannot be altered.
4	Ref.Value	35.67	Data field: Current humidity value. This value can be altered and serves as reference value, which can be recorded.
5	Acquired	0	Shows the number of acquired humidity values. This value cannot be altered.
6	[Acquire]		Action field: Record a reference value and associated current measured values for humidity. All values are stored in the table of recorded values. A maximum of 100 reference values can be recorded.
7	[Delete]		Action field: Delete the humidity values acquired hitherto
8	[Adjust]		Action field: Adjust the data stored hitherto in the HC2 probe. The previous recorded values are deleted. <i>After calling up this action, the device must be restarted. This is done automatically.</i>

8.3.7 Temperature Settings

The menu **Temperature Settings** allows adjustments to the [temperature settings](#) (HC2 or Pt100 probe).

Caution!

- The menu **Temperature Settings** only exists if the device has an HC2 or Pt100 probe.
- Adjustments of the temperature probe should only be made with the appropriate knowledge and devices (exact temperature reference).
- Changes to the adjustment settings have a direct influence on the temperature measurement of the device.
- The action **[Adjust]** may only be carried out when there is an HC2 or Pt100 probe connected.

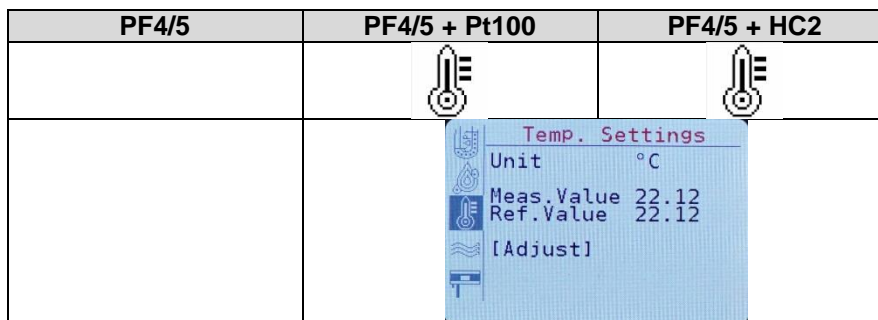

Menu description

Line	Designation	Value	Description
1	Unit	°C °F	Selection field: Unit for the temperature
2			Empty line
3	Meas. Value	23.37	Current temperature value. This value is used for comparison, and cannot be altered.
4	Ref. Value	23.37	Data field: Reference value for the temperature This value can be altered and serves as reference value for a possible adjustment of the temperature
5			Empty line
6	[Adjust]		Action field: The difference between the current temperature and reference value is determined and stored in the device as offset value. <ul style="list-style-type: none"> • PF4/5 with Pt100: Adjustment of the data stored in the device • PF4/5 with HC2: Adjustment of the data stored in the HC2 probe After calling up this action, the device must be restarted. This is done automatically.
7...8			Empty lines

8.3.8 Flow Settings

The menu **Flow Settings** allows adjustments to the settings for the [flow measurement](#).

There are two versions of the menu **Flow Settings**, for the activated and the deactivated state of the flow measurement.

Note

- Meaningful [flow measurements](#) can only be performed with the appropriate equipment.

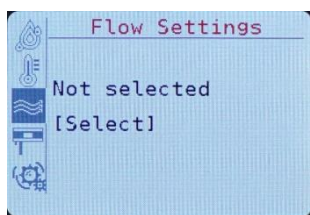
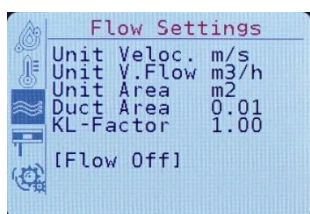
PF4/5	PF4/5 + Pt100	PF4/5 + HC2
		
Flow deactivated		
Flow activated		

Menu description (flow deactivated)

Line	Designation	Value	Description
1			Empty line
2			Empty line
3	Not selected		Information line
4			Empty line
5	[Select Flow]		Action field: Activate flow measurement After calling up this action, the device must be restarted. This is done automatically.
6...8			Empty lines

Menu description (flow activated)

Line	Designation	Value	Description
1	Unit Veloc.	m/s km/h fps mph	Selection field: Unit for the flow measurement
2	Unit V.Flow	m3/h m3/min l/min l/s cfm cfs	Selection field: Unit for the volume flow
3	Unit Area	cm2 m2 in2 ft2	Selection field: Unit for the duct area of the volume flow
4	Duct Area	0.03	Data field: Duct area for calculation of the volume flow

5	KL-Factor	1.00	Data field: Current KL-factor for calculation of the volume flow
6			Empty line
7	[Flow Off]		Action field: Deactivate flow measurement After calling up this action, the device must be restarted. This is done automatically.
8			Empty line

8.4 Submenus

8.4.1 Display Settings

The submenu **Display Settings** allows adjustments to the display settings.

The settings for Line 1 to Line 4 depend on the configuration of the device.

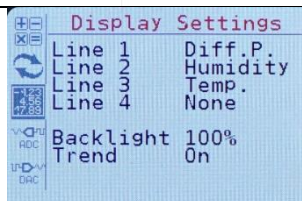
PF4/5	PF4/5 + Pt100	PF4/5 + HC2
	-1.23 4.56 17.89	
		

Menu description

Line	Designation	Value	Description
1	Line 1	Diff.P. (*)	Selection field: Display of the parameter in Line 1
2	Line 2	Humidity (*)	Selection field: Display of the parameter in Line 2
3	Line 3	Temp. (*)	Selection field: Display of the parameter in Line 3
4	Line 4	Ambi.P. (*)	Selection field: Display of the parameter in Line 4 The display in Line 4 is smaller than the display in Line 1 to 3
5			Empty line
6	Backlight	100%	Selection field: Brightness of the backlight (20% strongly dimmed, 100% not dimmed)
7	Trend	Off / On	Selection field: Display of the trend The trend setting can only be activated for lines 1 to 3. The factory default is On .
8			Empty line

(*) Options for Line 1 to 3

PF4/5	PF4/5 + Pt100	PF4/5 + HC2	Explanation
None	None	None	No display
Diff.P.	Diff.P.	Diff.P.	Differential pressure
-	-	Humidity	Humidity
-	Temp.	Temp.	Temperature
-	-	Calc.	Calculation
An.Inp.	An.Inp.	An.Inp.	Analog input
Ambi.P.	Ambi.P.	Ambi.P.	Ambient pressure
Flow	Flow	Flow	Flow (*)
V.Flow	V.Flow	V.Flow	Volume flow (*)
			(*) Selection only possible when Flow activated



(*) Options for Line 4

PF4/5	PF4/5 + Pt100	PF4/5 + HC2	Explanation
None	None	None	No advice
Diff.P.	Diff.P.	Diff.P.	Differential pressure
-	-	Humidity	Humidity
-	Temp.	Temp.	Temperature
-	-	Calc.	Calculation
An.Inp.	An.Inp.	An.Inp.	Analog input
Ambi.P.	Ambi.P.	Ambi.P.	Ambient pressure
Flow	Flow	Flow	Flow (*)
V.Flow	V.Flow	V.Flow	Volume flow (*)
Duct A.	Duct A.	Duct A.	Duct area (*)
			(*) Selection only possible when Flow activated

Displays Lines 1 to 4

Depending on the selection for Lines 1 to 4, the display content is structured differently.

Line 1...3	Line 4	Display
No line activated	Not activated	Info line is shown
No line activated	Activated	Info line is shown
One line activated	Not activated	Info line is shown
One line activated	Activated	Info line is shown
Two lines activated	Not activated	Info line is shown
Two lines activated	Activated	Info line is shown

Three lines activated	Not activated		Info line is shown
Three lines activated	Activated		Info line cannot be shown

Information line

If not all lines 1 to 4 of the display are shown, the bottom line of the display shows information about the device status.

Display	Explanation
PF4/5	In normal operation the name of the device, e.g. PF4 or PF5, is shown.
Alarm	An alarm has been activated. In this case, the information display flashes every second and indicates the alarm color. The alarm colors can be set via the Rotronic HW4 software and the Modbus protocol .
Fixed Values	Fixed values are used on the device.
Sensor Alarm	A sensor alarm (HC2) has been activated.

Display colors

The colors for the background, texts (measured values), alarms and pre-alarms can only be set via the [Rotronic HW4 software](#) and the [Modbus protocol](#).

The default settings are **Black** for the background, **White** for the texts (measured values), **Red** for alarms and **Yellow** for pre-alarms.

8.4.2 Analog Input Settings

The submenu **Analog Input Settings** allows adjustments to the [settings of the analog input](#) of the PF4/5.

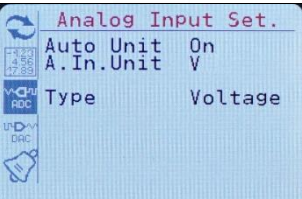
PF4/5	PF4/5 + Pt100	PF4/5 + HC2
 ADC		
		

Menu description

Line	Description	Value	Description
1	Auto Unit	Off / On	Selection field: Automatic display of a unit ([V] or [mA]) if the user has not selected another unit. The factory default is On .
2	A.In. Unit	(empty) V mA ppm	Selected unit for the analog input Automatically selected unit, depending on the analog input type [V] or [mA], if Auto Unit is ON and no unit entered by the user exists, e.g. [ppm]. This value cannot be altered.

			The unit selected by the user, e.g. [ppm], can only be selected via the Rotronic HW4 software or the Modbus protocol .
3			Empty line
4	Type	Voltage Current	Selection field: Selection of the type of analog input <ul style="list-style-type: none"> • Voltage: Voltage input between 0 and 10 [V] • Current: Current input between 0 and 24 [Ma]
5...8			Empty lines

8.4.3 Analog Output Settings

The submenu **Analog Output Settings** allows adjustments to the settings of the [analog outputs](#).

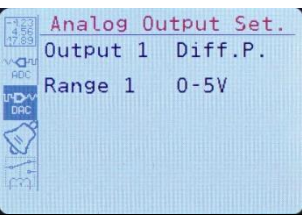
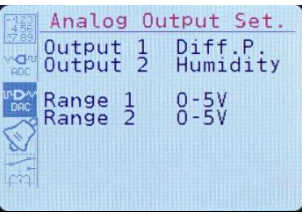
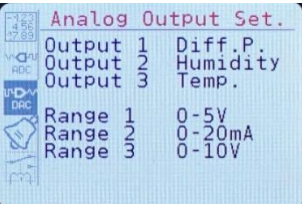
PF4/5	PF4/5 + Pt100	PF4/5 + HC2
 DAC		
1 Analog Output		
		
2 Analog Outputs		
		
3 Analog Outputs		
		

Menu description (1 analog output)

Line	Designation	Value	Description
1	Output 1	Diff.P. (*)	Selection field: Parameter for analog output 1
2			Empty line
3	Range 1	0-10V (**)	Selection field: Selection of analog output range 1
4...8			Empty lines

Menu description (2 analog outputs)

Line	Designation	Value	Description
1	Output 1	Diff.P. (*)	Selection field: Parameter for analog output 1
2	Output 2	Humidity (*)	Selection field: Parameter for analog output 2
3			Empty line
4	Range 1	0-1V (**)	Selection field: Selection of analog output range 1
5	Range 2	0-10V (**)	Selection field: Selection of analog output range 2
6...8			Empty lines

Menu description (3 analog outputs)

Line	Designation	Value	Description
1	Output 1	Diff.P. (*)	Selection field: Parameter for analog output 1
2	Output 2	Humidity (*)	Selection field: Parameter for analog output 2
3	Output 3	Temp. (*)	Selection field: Parameter for analog output 3
4			Empty line
5	Range 1	0-1V (**)	Selection field: Selection of analog output range 1
6	Range 2	0-10V (**)	Selection field: Selection of analog output range 2
7	Range 3	0-20mA (**)	Selection field: Selection of analog output range 3
8			Empty line

(*) Options for Output 1 to 3

PF4/5	PF4/5 + Pt100	PF4/5 + HC2	Explanation
None	None	None	No display
Diff.P.	Diff.P.	Diff.P.	Differential pressure
-	-	Humidity	Humidity
-	Temp.	Temp.	Temperature
-	-	Calc.	Calculation
An.Inp.	An.Inp.	An.Inp.	Analog input
Ambi.P.	Ambi.P.	Ambi.P.	Ambient pressure
Flow	Flow	Flow	Flow (*)
V.Flow	V.Flow	V.Flow	Volume flow (*)
			(*) Selection only possible when Flow activated

(**) Options for Range 1 to 3

PF4/5	Explanation
0 – 1V	Fixed output range from 0 to 1.0 V
0 – 5V	Fixed output range from 0 to 5.0 V
0 – 10V	Fixed output range from 0 to 10.0 V
0 – 20mA	Fixed output range from 0 to 20.0 mA
4 – 20mA	Fixed output range from 4.0 mA to 20.0 mA

8.4.4 Alarm Settings

The submenu **Alarm Settings** allows adjustments to the [settings for alarm sources](#).

Depending on the device version, there are various parameters that can be set as alarm source. The alarm source can either be switched off or switched on (**Off/On**). The factory default is **Off** for all possible alarm sources.

A [relay alarm](#) can be activated as soon as a switched-on alarm source is exceeded or not reached.

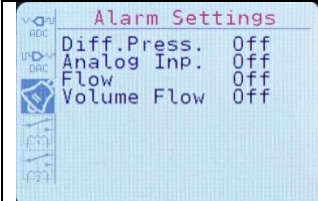
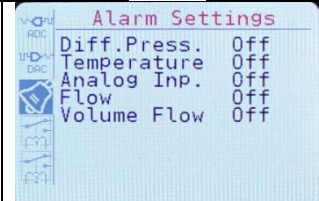
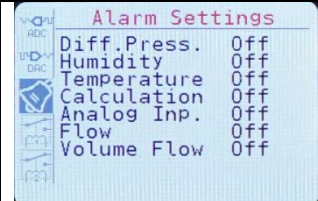
PF4/5	PF4/5 + Pt100	PF4/5 with HC2
		
 <p>Alarm Settings</p> <p>Diff.Press. Off</p> <p>Analog Inp. Off</p> <p>Flow Off</p> <p>Volume Flow Off</p>	 <p>Alarm Settings</p> <p>Diff.Press. Off</p> <p>Temperature Off</p> <p>Analog Inp. Off</p> <p>Flow Off</p> <p>Volume Flow Off</p>	 <p>Alarm Settings</p> <p>Diff.Press. Off</p> <p>Humidity Off</p> <p>Temperature Off</p> <p>Calculation Off</p> <p>Analog Inp. Off</p> <p>Flow Off</p> <p>Volume Flow Off</p>

Menu description (PF4/5)

Line	Designation	Value	Description
1	Diff. Press.	Off / On	Selection field: Differential pressure as alarm source
2	Analog Inp.	Off / On	Selection field: Analog input as alarm source
3	Flow	Off / On	Selection field: Flow as alarm source, <i>only if flow measurement activated</i>
4	Volume Flow	Off / On	Selection field: Volume flow as alarm source, <i>only if flow measurement activated</i>
5...8			Empty lines

Menu description (PF4/5 + Pt100)

Line	Designation	Value	Description
1	Diff. Press.	Off / On	Selection field: Differential pressure as alarm source
2	Temperature	Off / On	Selection field: Pt100 temperature as alarm source
3	Analog Inp.	Off / On	Selection field: Analog input as alarm source
4	Flow	Off / On	Selection field: Flow as alarm source, <i>only if flow measurement activated</i>
5	Volume Flow	Off / On	Selection field: Volume flow as alarm source, <i>only if flow measurement activated</i>
6...8			Empty lines

Menu description (PF4/5 + HC2)

Line	Designation	Value	Description
1	Diff. Press.	Off / On	Selection field: Differential pressure as alarm source
2	Humidity	Off / On	Selection field: HC2 humidity as alarm source
3	Temperature	Off / On	Selection field: HC2 temperature as alarm source
4	Calculation	Off / On	Selection field: Calculations as alarm source
5	Analog Inp.	Off / On	Selection field: Analog input as alarm source
6	Flow	Off / On	Selection field: Flow as alarm source, <i>only if flow measurement activated</i>
7	Volume Flow	Off / On	Selection field: Volume flow as alarm source, <i>only if flow measurement activated</i>
8			Empty line

8.4.5 Relay Sources

The submenu **Relay Sources** allows adjustments to the parameters for relay control.

Depending on the device version, there are various parameters that can be set as relay source.

A [relay alarm](#) can be triggered as soon as a parameter exceeds or falls below an [alarm threshold](#) and the global alarm bit of the corresponding parameter is activated.

For each parameter there are 4 different [possibilities to activate the relay](#) **Off**, **Low**, **High** and **Hi/Lo**. All settings are set to **Off** on delivery.

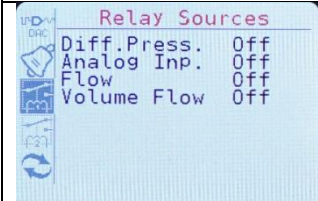
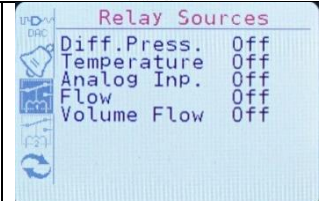
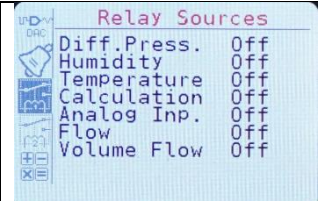
PF4/5	PF4/5 + Pt100	PF4/5 + HC2
		
		

Menu description (PF4/5)

Line	Designation	Value	Description
1	Diff. Press.	Low (*)	Selection field: Differential pressure as relay source
2	Analog Inp.	High (*)	Selection field: Analog input as relay source
3	Flow	Hi/Lo (*)	Selection field: Flow as relay source, <i>only if flow measurement activated</i>
4	Volume Flow	Off (*)	Selection field: Volume flow as relay source, <i>only if flow measurement activated</i>
5...8			Empty lines

Menu description (PF4/5 + Pt100)

Line	Designation	Value	Description
1	Diff. Press	Low (*)	Selection field: Differential pressure as relay source
2	Temperature	High (*)	Selection field: Pt100 temperature as relay source
3	Analog Inp.	Hi/Lo (*)	Selection field: Analog input as relay source
4	Flow	Off (*)	Selection field: Flow as relay source, <i>only if flow measurement activated</i>
5	Volume Flow	Low (*)	Selection field: Volume flow as alarm source, <i>only if flow measurement activated</i>
6...8			Empty lines

Menu description (PF4/5 + HC2)

Line	Description	Value	Description
1	Diff. Press	Low (*)	Selection field: Differential pressure as relay source
2	Humidity	High (*)	Selection field: HC2 humidity as relay source
3	Temperature	Hi/Lo (*)	Selection field: HC2 temperature as relay source
4	Calculation	Off (*)	Selection field: Calculations as relay source
5	Analog Inp.	Low (*)	Selection field: Analog input as relay source
6	Flow	High (*)	Selection field: Flow as relay source, <i>only if flow measurement activated</i>
7	Volume Flow	Hi/Lo (*)	Selection field: Volume flow as relay source, <i>only if flow measurement activated</i>
8			Empty line

(*) There are 4 different [possibilities to activate the relay](#) per parameter:

- **Off**
The relay is never activated.
- **Low**
The relay is activated if the lower alarm threshold of the parameter is not reached.
- **High**
The relay is activated if the upper alarm threshold of the parameter is exceeded.
- **Hi/Lo**

All settings are set to **Off** on delivery.

8.4.6 Relay Settings

The submenu **Relay Settings** allows adjustments to the [settings](#) of how the relay should respond to an alarm.

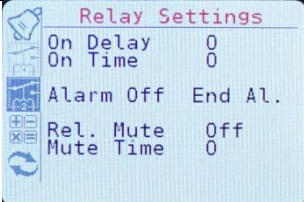
PF4/5	PF4/5 + Pt100	PF4/5 + HC2
		
		

Menu description

Line	Designation	Value	Description
1	On Delay	10	Data field: Current delay before the relay is activated (in seconds)
2	On Time	120	Data field: Current time for which the relay stays active (in seconds)
3			Empty line
4	Alarm Off	No End! End Al. End Time End AorT	Selection field: Stop response of the relay <ul style="list-style-type: none"> • No End! The alarm stays active until the device is restarted! • End Al. The alarm stays active until the alarm state is terminated. • End Time The alarm stays active until the set On Time has elapsed. • End AorT The alarm stays active until the alarm state is terminated or the set On Time has elapsed.
5			Empty line
6	Rel. Mute	Off / On	Selection field: Muting of the alarm The factory default is Off .
7	Mute Time	100	Data field: Time for which an alarm is set to "Mute" (Relay Off) (in seconds)
8			Empty line

Muting of the relay

Pressing the **Enter key** (✓) during an active relay alarm mutes the relay and deactivates it during the time set in **Mute Time**. After the **Mute Time** has elapsed, the relay is reactivated if a relay alarm is still active.

8.4.7 Calculation Settings

The submenu **Calculation Settings** allows adjustments to the settings for the [psychrometric calculations](#).

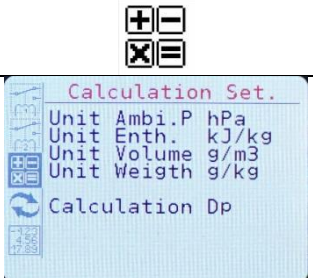
PF4/5	PF4/5 + Pt100	PF4/5 + HC2
		
		Calculation Set. Unit Ambi.P hPa Unit Enth. kJ/kg Unit Volume g/m3 Unit Weigth g/kg Calculation Dp

Menu description

Line	Designation	Value	Description
1	Unit Ambi.P.	hPa inHg psi	Selection field: Unit for the ambient pressure (hPa, inHg, psi)
2	Unit Enth.	kJ/kg BTU/lb	Selection field: Unit for the enthalpy (kJ/kg, BTU/lb)
3	Unit Volume	g/m3 gr/ft3	Selection field: Unit for the density per volume (g/m ³ , gr/ft ³)
4	Unit Weight	g/kg gr/lb	Selection field: Unit for the density per weight (g/kg, gr/lb)
5			Empty line
6	Calculation	Dew P. Frost P. Wet bulb Enthalpy Vap.Con. Sp.Humi. Mix.Rat. Sat.Con. Part.Pr. Sat.Pr.	Selection field: Calculation to be carried out <ul style="list-style-type: none"> • Dew P. (Dp) Dew point • Frost P. (Fp) Frost point • Wet bulb (Tw) Wet-bulb temperature • Enthalpy (H) Enthalpy • Vap.Con. (Dv) Vapor concentration • Sp.Humi. (Q) Specific humidity • Mix.Rat. (R) Mixing ratio • Sat.Con. (Ds) Saturation vapor concentr. • Part.Pr. (E) Vapor partial pressure • Sat.Pr. (Ew) Vapor saturation pressure
7...8			Empty lines

8.4.8 Communication Settings

The submenu **Communication Settings** allows adjustments to the settings for the communication interfaces [RS485](#) and [Ethernet including DHCP server selection](#).

Depending on the device version, certain communication interfaces may not exist, in which case **Not used** is shown in the display.



Menu description

Line	Designation	Value	Description
1	Device/N:	0	<i>RS485 active:</i> Data field: Device number, is used for communication via the RS485 interface (e.g. Modbus RTU)
		Not used	<i>RS485 inactive:</i> "Not used" is shown
2			Empty line
3	Ethernet:	Not used	<i>Ethernet inactive:</i> "Not used" is shown
		DHCP Off DHCP On	<i>Ethernet active:</i> Selection field: DHCP server off / on The factory default is DHCP Off
4	IP:		<i>Ethernet inactive:</i> Empty line
		192.168.001.001	<i>Ethernet active and DHCP off:</i> Data field: Setting possibility for the fixed IP address
		010.065.100.151	<i>Ethernet active and DHCP on:</i> Display of the IP address assigned by the DHCP server (not selectable) The host name for the DHCP setting is: PF45-xxxxxxxxxx, where xxxxxxxxxxxx corresponds to the 10-digit serial number. Serial numbers with less than 10 digits are padded with leading zeros to 10 digits.
5...8			Empty lines

9. Firmware Update

A PC running the [Rotronic HW4 software](#) is needed to update the firmware of a PF4/5. The update can be performed via the service interface (AC3006/AC3009 cable), [Ethernet](#) or [RS485](#).

The PF4 must remain connected to the computer throughout the update process and there must be a stable power supply for the complete duration of the process.

The PF4/5 boots automatically after the firmware update.

10. Technical Data

General	
Device type	Differential pressure transmitter with additional parameters such as ambient air pressure, analog input (current or voltage). Supplemented by optional humidity and temperature measurement, various analog and digital output interfaces as well as freely configurable relay changeover contacts, the PF4/5 is equipped for comprehensive measurement, control and regulating applications in clean rooms and their environments.
Circuit type	4-wire
Type of mounting	W (Wall)

General Specifications	
Display (*)	TFT color LCD, visible pixels: 180 * 270, visible area 27 x 40 mm (height x width)
Menu navigation (*)	4 pushbuttons (for operation with protective gloves)
Enclosure material	ABS
IP protection class	IP65 (without Ethernet) / IP 40 (with Ethernet)
Dimensions	129 mm x 72 mm x 45 mm (see technical drawing)
Weight (excl. packaging)	243 g Version with display and Ethernet
Self-heating	Not relevant, sensor is temperature-compensated internally
Startup time	< 5 s
Measurement interval	1 s
Memory function	Via HW4 software
Simulation	Possible to set fixed values for system validation
Application range	-5 ... 60 °C / 0...100 %RH, non-condensing
Storage and transport conditions	-5 ... 60 °C / 0...100 %RH, non-condensing
Altitude	Up to 2,000 m ASL
Electrical connections	2 x 8-pin cable gland (Optional) MOK 7-pin (version with HC2 connection) (Optional) Binder 4-pin (version with Pt100 connection) (Optional) RJ45 Ethernet socket (version with Ethernet)
Mechanical connections	2 x 4 mm pressure connections on side

Conformity with Standards	
CE / EMC immunity	EMC Directive 2004/108/EC: EN 61000-6-1:2016 EN 61000-6-2:2016 EN 61000-6-4:2007+A1:2011
Solder type	Lead free (RoHS directive)
Fire protection class	Corresponds to UL94-HB
FDA / GAMP directives	CFR21 Part 11 and GAMP5

Power Supply and Connections	
Supply voltage	Galvanically isolated: 18 ... 48 VDC / 16 ... 35 VAC, 50/60 Hz Galvanically isolated: Power over Ethernet (PoE) 802.3 af, Class 2 (only version with Ethernet)
Rated current consumption	< 300 mA / 24 VDC
Polarity protection	Protective diode on V+ and on V-

Differential Pressure Measurement	
Measurement ranges	PF4: ± 10 Pa / ± 25 Pa / ± 50 Pa / ± 100 Pa / ± 250 Pa / ± 500 Pa PF5: ± 25 Pa / ± 50 Pa / ± 100 Pa / ± 250 Pa / ± 500 Pa
Accuracy	± 1.0 %FSS
Response time τ_{63}	< 1 s, typical
Ambient pressure dependence	PF4: compensated PF5: none
Pressure resistance	PF4: 500,000 Pa (5 bar) PF5: 70,000 Pa (0.7 bar)
Long-term stability	PF4: $\pm 0.05\%$ FSS/year (typ.) / $\pm 0.1\%$ FSS/year (max.) PF5: $\pm 0.25\%$ FSS (typ.) per year \rightarrow ± 250 and ± 500 Pa measurement range $\pm 0.3125\%$ FSS (typ.) per year \rightarrow ± 100 Pa measurement range $\pm 0.625\%$ FSS (typ.) per year \rightarrow ± 50 Pa measurement range $\pm 1.25\%$ FSS (typ.) per year \rightarrow ± 25 Pa measurement range
Adjustment points	Multipoint adjustment, up to 128 reference points factory adjustment or user adjustment Only 31 reference points can be adjusted using the menu.
Resolution	0.01 Pa
Sensor test	Sensor alarm on interruption or defect

Humidity and Temperature Measurement (Optional)	
With HC2	See document E-M-HC2A Probes >Specifications.

Calculated Parameters (Optional with HC2)	
Psychrometric calculations	Dew point (Dp) above and below freezing point Frost point (Fp) below freezing point and dew point above freezing point Wet bulb temperature (Tw) Enthalpy (H) Vapor concentration (Dv) Specific humidity (Q) Mixing ratio by weight (R) Vapor concentration at saturation (Dvs) Vapor partial pressure (E) Vapor saturation pressure (Ew)

Possible Pressure Units	
Pascal	1 Pa = 1 N/m ²
Inch water column	1 inH ₂ O (4 °C) = 249.089 Pa
Milli-pound-force per square inch	1 mpsi = 0.001 psi = 6.89476 Pa
Millibar	1 mbar = 0.001 bar = 100 Pa
mm mercury column	1 mmHg (0 °C) = 133.322 Pa
mm water column	1 mmH ₂ O (4 °C) = 9.80665 Pa
Torr	1 Torr = 133.322 Pa
Gram per square centimeter	1 g/cm ² = 98.0665 Pa

Temperature Measurement Pt100 (Optional)	
With Pt100	See document E-M-PT100-Probes >Specifications.

Ambient Pressure Sensor	
Absolute accuracy	± 1 hPa (0...65 °C; 950...1100 hPa) max.
Relative accuracy	0.12 hPa (25 °C; 950...1050 hPa) typical
Temperature coefficient offset	1.5 Pa/K (+25...40 °C @ 900 hPa)
Working range - pressure	300...1100 hPa
Working range - temperature	-5...65 °C

Analog Input	
Number	1
Measurement range	Voltage: 0 to 10.0 V, input resistance > 50 kΩ Current: 0 to 24 mA, measurement resistance 412.5 Ω
Accuracy offset	0.5% of current measured value
Other information	The analog input is freely scalable

Analog Outputs	
Number	Minimum 1, maximum 3 (optional)
Assignment	Outputs can be assigned to every measured value
Default parameters	Differential pressure
Input signal	Freely configurable, range limits ±100,000,000
Standard ranges	0 to 1 V 0 to 5 V 0 to 10 V 0 to 20 mA 4 to 20 mA
Default range	Per order code
Measurement signal	Freely scalable
Accuracy (at 23 °C)	Voltage output: ±1 mV Current output: ±20 µA
Refresh interval	1 s
Short circuit tolerant	Yes
Maximum load	500 Ω
Load compensation	Adjustable
Minimum load resistance	Voltage output: 1 kΩ
Load influence compensation	Yes
Resolution	0 to 1 V 13 bit, otherwise 16 bit







Alarms	
Assignment	Alarms can be assigned to every measured value
Alarm thresholds	Alarm High, top alarm threshold Pre Alarm High, below Alarm High Pre Alarm Low, above Alarm Low Alarm Low, bottom alarm threshold
Hysteresis	Applies to Alarm Low and High
Alarm indication on display	All alarms
Alarm generation	Low/High alarms

Relays	
Number of relays	1 relay
Type of relay	Mechanical
Contacts	Volt-free changeover switch (NC – COM – NO)
Switching capacity	30 VDC / 1 A or 35 VAC / 1 A
Alarm assignment	The possible alarms can be switched to the relay in an OR-link (Alarm Low, Alarm High, Alarm Low or High) from every measured value.

Digital Interfaces	
Service interface	Via Mini-USB connector inside the device
Ethernet (optional)	Wired (10 Base T or 100 Base T)
RS485 (optional)	Half-duplex, 19,200 Baud

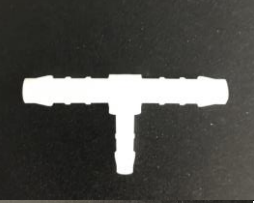
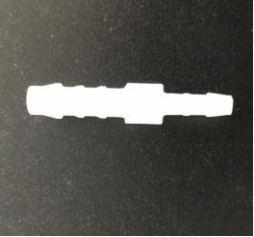
Protocols	
Rotronic-ASCII-Protocol	Ethernet, RS485, service interface
Modbus RTU	RS485, service interface
Modbus TCP	Ethernet

11. Accessories

Order Code	Description	PF4/5 + HC2A
AC3006	Service cable with protocol converter USB ↔ UART	
AC3009	Service cable with protocol converter USB ↔ UART	
AC6001	Connection tube 4 mm internal diameter internally calibrated	
AC6007/T	T-connection 6mm/4mm/6mm	
AC6007/I	Connection 6mm to 4mm for pitot tube	
PT-100 PT-150 PT-200 PT-250 PT-350	Pitot tube blades for measurement of volume flow. 2x 1 m tube (6mm internal diameter) included.	
HC2A-Sx	Humidity/Temperature probe with E2 connector	
AC19xx	Pt100 probe with Binder 4-pin connector	

12. Dimensions

The PF4/5 comes as wall-mounted unit in a normal ROTRONIC housing. The following drawings show the relevant overall dimensions in mm.

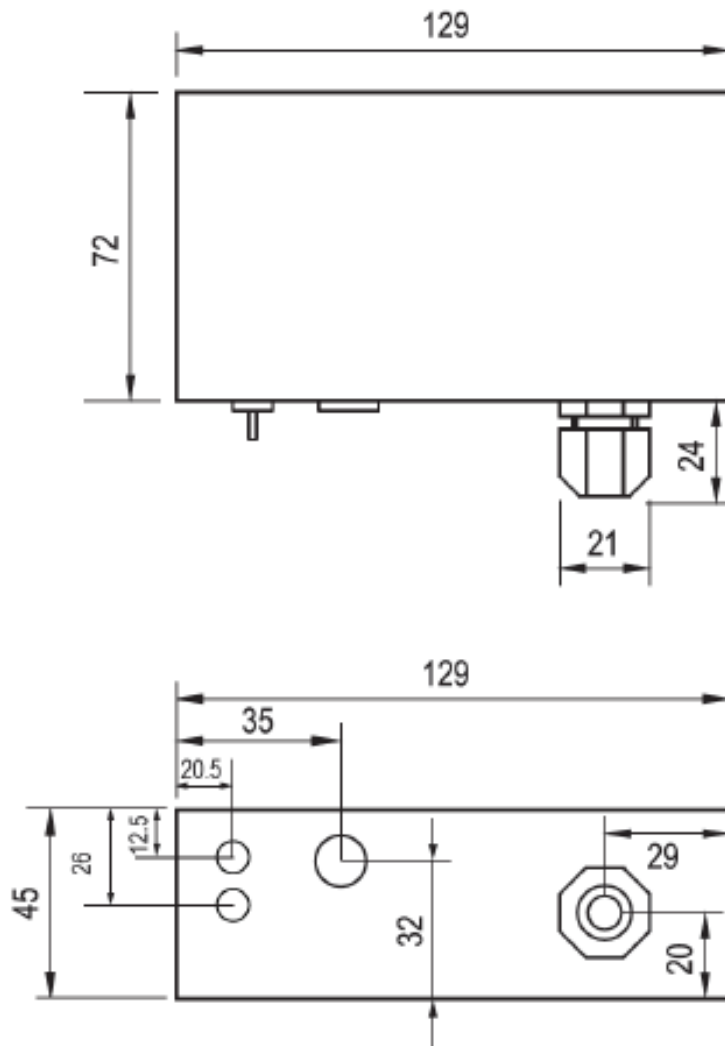



13. Additional Documents

Document Name	Content
E-M-HC2A-V1.2	HC2A probes manual
E-M-HW4v3-Main	HW4 software main manual
E-M-TCPIP-Conf	Manual for Ethernet configuration of ROTRONIC instruments
E-M-AC3000-CP	Communication protocol for all AirChip3000 instruments
E-M-HW4v3-P-003_00	HW4 software manual for PF4/5
E-M-PF4_PF5-Modbus	Modbus manual for PF4/5
Pitotube	Datasheet & installation instructions

14. Document Versions

Doc. Release	Date	Remark
E-M-PF4_PF5-V1.0	April 2019	Release document