



# Promet EExd Process Moisture Analyzer User Manual



Please fill out the form(s) below for each instrument that has been purchased.

Use this information when contacting Michell Instruments for service purposes.

Product Name	
Order Code	
Serial Number	
Invoice Date	
Installation Location	
Tag Number	

Product Name	
Order Code	
Serial Number	
Invoice Date	
Installation Location	
Tag Number	

Product Name	
Order Code	
Serial Number	
Invoice Date	
Installation Location	
Tag Number	



## Promet EExd

For Michell Instruments' contact information please go to  
[www.michell.com](http://www.michell.com)

© 2021 Michell Instruments

This document is the property of Michell Instruments Ltd and may not be copied or otherwise reproduced, communicated in any way to third parties, nor stored in any Data Processing System without the express written authorization of Michell Instruments Ltd.

---

## Contents

Safety .....	vii
Electrical Safety .....	vii
Pressure Safety .....	vii
Toxic Materials .....	vii
Repair and Maintenance .....	vii
Calibration (factory validation) .....	vii
Safety Conformity .....	vii
Abbreviations .....	viii
Warnings .....	viii
<b>1 INTRODUCTION .....</b>	<b>1</b>
1.1 General.....	1
1.2 Sample Gas Path .....	1
1.3 Operating Overview .....	2
1.4 User Display and Interface .....	2
1.5 Advanced Sensor Technology .....	2
1.6 Measurement Units.....	3
1.7 Elimination of Temperature Effects.....	3
1.8 Calibration Maintenance.....	4
1.9 Promet EExd Sampling System .....	4
<b>2 INSTALLATION .....</b>	<b>5</b>
2.1 Electrical Safety.....	5
2.1.1 Equipment Ratings and Installation Details.....	5
2.2 Hazardous Area Safety.....	8
2.3 Pressure Safety .....	9
2.4 Lifting and Handling .....	9
2.5 Analyzer System.....	10
2.5.1 Pipework.....	11
2.5.2 Power Connection .....	13
2.5.3 Analog and Digital Communications .....	14
2.5.4 Process Alarms and Analyzer Status Alarms .....	14
2.6 Promet EExd Start-Up Purge Procedure.....	15
2.7 Sample Gas Flows .....	16
2.8 Sample Flow Alarms (Optional).....	16
<b>3 OPERATION .....</b>	<b>17</b>
3.1 System Operation.....	17
3.2 User Interface .....	17
3.2.1 Interface Controls .....	17
3.2.2 'Up/Down Arrow' Buttons.....	18
3.2.3 'SELECT' Button .....	18
3.2.4 'MENU/MAIN' Button .....	18
3.3 Menu Structure .....	19
3.4 MAIN MENU Page.....	20
3.5 STATUS Page .....	20
3.6 LOGGING MENU Page.....	21
3.6.1 VIEW LOGGED DATA Page.....	21
3.6.2 VIEW STATISTICS Page.....	22
3.6.3 VIEW SYSTEM FAULTS Page .....	23
3.7 VIEW/ADJ VARIABLES Page .....	23
3.7.1 Password.....	23
3.7.2 VARIABLES Pages .....	24
3.7.3 Single Channel Configuration VARIABLES Pages .....	24

3.7.4	Dual Channel Configuration VARIABLES Pages .....	25
3.8	SENSOR INFO Page .....	26
3.9	CONTACT INFO Page .....	27
4	MAINTENANCE .....	28
4.1	Enclosure Cover and User Interface .....	28
4.2	Replacement of the Moisture Sensor Assembly .....	29
4.3	Replacement of the Flow Switch (if fitted) .....	31
4.4	Troubleshooting.....	32
4.4.1	Error Messages .....	32
4.4.2	Logged Error Codes.....	33
4.4.3	Analyzer Status Alarm Relay.....	34

## Figures

Figure 1	Promet EExd Sampling System .....	4
Figure 2	Power Connection Connector.....	5
Figure 3	Earthing Stud And Nut Washer Assembly .....	6
Figure 4	Promet EExd Mounting Drawing.....	10
Figure 5	Pipework Connections.....	11
Figure 6	Hook-up Wiring Diagram .....	13
Figure 7	Minimum Requirements for Start-up Purging .....	16
Figure 8	MAIN Page in Single Channel (top) and Dual Channel Modes.....	17
Figure 9	User Interface .....	17
Figure 10	Up/Down Arrow Buttons .....	18
Figure 11	'SELECT' Button.....	18
Figure 12	'MENU/MAIN' Button.....	18
Figure 13	Menu Structure .....	19
Figure 14	MAIN MENU Page.....	20
Figure 15	STATUS Page .....	20
Figure 16	LOGGED DATA Page .....	21
Figure 17	STATISTICS Page .....	22
Figure 18	LOGGED ERROR Page.....	23
Figure 19	PASSWORD Page.....	23
Figure 20	VARIABLES Page .....	24
Figure 21	SENSOR INFO Page .....	26
Figure 22	CONTACT INFO Page.....	27
Figure 23	Ribbon Cable Connection .....	29
Figure 24	Moisture Sensor Assembly Replacement.....	30
Figure 25	Error Message Line .....	32
Figure 26	Logged Error Codes.....	33
Figure 27	Mounting Drawing .....	38
Figure 28	Pipework Connections.....	39
Figure 29	System Wiring Diagram.....	40
Figure 30	Calibration Correction Data.....	50
Figure 31	Reading Holding Registers State Diagram.....	62
Figure 32	Write Single Register State Diagram.....	64

---

## Appendices

Appendix A	Technical Specifications.....	36
	A.1 Mounting Drawing .....	38
	A.2 Pipework Connections .....	39
	A.3 System Wiring Diagram.....	40
Appendix B	Variable Definitions .....	42
Appendix C	Modbus RTU Communications .....	47
	C.1 Introduction .....	47
	C.2 Modbus RTU Basics.....	47
	C.3 Physical Layer .....	47
	C.4 Termination Resistor .....	48
	C.5 Register Map .....	48
Appendix D	Modbus RTU Details .....	53
	D.1 Message Framing.....	53
	D.2 Implemented Functions.....	54
	D.3 Exceptions .....	58
Appendix E	Register Number Formats.....	60
Appendix F	Hazardous Area Certification .....	66
	F.1 Product Standards .....	66
	F.2 Product Certification .....	66
	F.3 Global Certificates/Approvals .....	66
	F.4 Special Conditions of Use .....	67
	F.5 Maintenance and Installation .....	67
Appendix G	Pressure Equipment Directive Compliance Statement .....	69
Appendix H	Quality, Recycling & Warranty Information.....	71
Appendix I	Return Document & Decontamination Declaration .....	73

## Safety

This manual contains all the required information to install, operate and maintain the Promet EExd. Prior to installation and use of this instrument, this entire manual should be read and understood. Installation and operation of this product should be carried out by suitably competent personnel only. The operation of this product must be in accordance with the terms of this manual and associated safety certificates. Incorrect installation and use of this product for other than its intended purpose will render all warranties void.

This product is intended for use in a Hazardous Area and is ATEX, IECEx and UKCA approved. It is also approved for use in North America in accordance with the requirements for the USA and Canada. The relevant certificates should be fully examined prior to installation or use of this product.



**Where this hazard warning symbol appears in the following sections, it is used to indicate areas where potentially hazardous operations need to be carried out and where particular attention to personal and personnel safety must be observed.**

## Electrical Safety

The instrument is designed to be completely safe when used with options and accessories supplied by the manufacturer for use with the instrument. The input power supply voltage limits are 90...260 V AC, 47/63 Hz.

## Pressure Safety

DO NOT permit pressures greater than the safe working pressure to be applied directly to the instrument. Refer to the Technical Specifications in Appendix A.

## Toxic Materials

The use of hazardous materials in the construction of this instrument has been minimized. During normal operation it is not possible for the user to come into contact with any hazardous substance which might be employed in the construction of the instrument. Care should, however, be exercised during maintenance and the disposal of certain parts.

## Repair and Maintenance

The instrument must only be maintained either by the manufacturer or an accredited service agent. Refer to [www.michell.com](http://www.michell.com) for details of Michell Instruments' worldwide offices contact information.

## Calibration (factory validation)

Prior to shipment, the analyzer undergoes stringent factory calibration to internationally traceable standards, NPL (UK) and NIST (USA). Due to the inherent stability of the instrument, only periodic calibration is required under normal operating conditions.

Michell Instruments recommends that calibration of the sensor should be maintained on a 12 monthly basis to ensure optimum operation. Michell Instruments offers a calibration exchange program, where a refurbished and re-certified sensor is supplied as an operational replacement and the original item returned to Michell to complete the exchange.

**NOTE: This interval may need to be reduced if the operation of the sensor is within potentially aggressive or corrosive sample media (such as sour natural gas). The calibration interval may therefore need to be shortened to 6 months (or lower in extreme cases) in order to maintain satisfactory analyzer performance.**

## Safety Conformity

This product meets the essential protection requirements of the relevant UK and EU directives. Further details of applied standards may be found in the product specification.

## Abbreviations

The following abbreviations are used in this manual:

A	Ampere
AC	alternating current
barg	pressure in bar (gauge)
°C	degrees Celsius
°F	degrees Fahrenheit
DC	direct current
dp	dew point
EU	European Union
lb	pound
lb/MMscf	pounds per million standard cubic feet
lbf-ft	pound force per foot
kg	kilogram
mA	milliamperes
max	maximum
min	minute(s)
mg/m <sup>3</sup>	milligrams per cubic meter
mm	millimeters
mV	millivolt(s)
N/C	normally closed
N/O	normally open
l/min	normal liters per minute
ppm <sub>v</sub>	parts per million by volume
psig	pressure in pound(s) per square inch (gauge)
RH	relative humidity
scfh	standard cubic feet per hour
temp	temperature
V	Volts

## Warnings

The following general warnings listed below are applicable to this instrument. They are repeated in the text in the appropriate locations.



**Where this hazard warning symbol appears in the following sections it is used to indicate areas where potentially hazardous operations need to be carried out.**



**Where this symbol appears in the following sections it is used to indicate areas of potential risk of electric shock.**

## 1 INTRODUCTION

### 1.1 General

The Promet EExd is designed for continuous, automatic measurement of the moisture content of processed natural gas, utilizing the Michell Ceramic Metal-Oxide Moisture Sensor. It is the result of more than 30 years' experience in the supply of analyzers to the Worldwide Oil & Gas Industry.

The analyzer comprises either a single or a dual channel moisture measurement sensor cell, control electronics and a display interface housed in an Exd enclosure. The analyzer is ATEX, IECEx and UKCA approved and is also approved for use in North America in accordance with the requirements for the USA and Canada. These and additional international approvals are listed in the Certification section of this manual. Certificates are available on the Michell Instruments website. A marking label located on the analyzer will identify appropriate approvals. An accompanying sample handling panel, designed to be positioned close to the process sample point to prepare the sample prior to entry into the Promet EExd, can also be supplied.

The instrument offers several user-selectable display options based on a calibrated dew-point measurement range of -100...+20 °C (-148...+68 °F), traceable to the humidity metrology standards of NPL (UK) and NIST (USA). The instrument further provides indication only in the ranges of +20...+30 °Cdp (+68...+86 °Fdp) and -100...-120 °Cdp (-148...-184 °F), equating to a moisture measurement capability of <1ppb<sub>v</sub>...>30,000 ppm<sub>v</sub>.

The requirements for operation are a 90...260 V AC, 47/63 Hz power supply of 180W and field communications Modbus RTU and/or 4...20 mA. Refer to the System Wiring Diagram in Appendix A.

### 1.2 Sample Gas Path

The Promet EExd analyzer system must be supplied with gas at the required pressure, via a sample gas handling panel providing suitable pressure, filtration & flow control. Sample gas entry and exit ports direct the gas through flame arrestors which, along with the Exd enclosure, provide the explosion proof protection. 1 or 2 separate measurement channels can be accommodated within the instrument.

The measurement system components are housed within a cast aluminum Exd rated enclosure. The enclosure has a screw cover incorporating a sealed window. It is chromate primed, polyester coated in black, and provides environmental protection to IP66/NEMA 4. An enclosure breather is fitted in the form of an additional flame arrestor. It is important that no pipe connection is made to this breather and that no restriction is allowed to occur.

All sample gas-wetted metallic parts are manufactured in AISI 316L stainless steel with Viton soft parts that comply with the NACE standard MR-01-75 (latest edition). Tube fittings are twin ferrule compression type. All electrical and gas connections are made through the base of the enclosure. Refer to the Mounting Drawing in Appendix A.

Channel 1 flow components comprise the following:

- **(Optional) Flow Switch 1 (FS1):** Provides indication that a flow is present throughout the moisture measurement stream
- **Pressure Transducer 1 (PT1):** Provides the measurement of the sample gas pressure within the moisture measurement cell

Channel 2 flow components comprise the following:

- **(Optional) Flow Switch 2 (FS2):** Provides indication that a flow is present throughout the moisture measurement stream
- **Pressure Transducer 2 (PT2):** Provides the measurement of the sample gas pressure within the moisture measurement cell

### 1.3 Operating Overview

The system continuously measures dew point/moisture and pressure in an uninterrupted gas stream flow. The flow switch, if fitted, will notify the system if the gas flow falls below the recommended rate.

Moisture and pressure for each channel are logged at a user-defined interval. The logs are available through the user interface or via the serial communications. Two 4...20 mA outputs for each channel are available to remotely read the dew point/moisture and pressure in real time.

### 1.4 User Display and Interface

The Promet EExd User Display and Interface Unit is presented via the circular window of the enclosure. Operation is achieved by a unique system, which allows full control through the glass of the enclosure cover. The cover is fully detachable for greater access into the enclosure during the installation and initial set-up of the instrument. During normal operation of the instrument the cover must remain fully secured.

### 1.5 Advanced Sensor Technology

The Promet EExd utilizes the Michell Ceramic Metal-Oxide Moisture Sensor, an advanced impedance sensor technology with more than 1,000 installations in natural gas and petrochemical applications today. Semiconductor thick- and thin-film technologies combine in metallized ceramics and achieve a durable sensor with measurement capability from lower than 10 ppb<sub>v</sub> moisture content and high-pressure capability up to 138 barg (2000 psig).

Unlike older aluminum-oxide technologies, the inherent immunity to pressure shock of the Ceramic Metal-Oxide Moisture Sensor avoids the risk of sensor failure at commissioning or shut-down. The inert nature of the sensor gives long-term resistance to chemical attack, even in extremely sour gas with percentage level H<sub>2</sub>S concentrations. The Ceramic Metal-Oxide Moisture Sensor response characteristic is proportional to the partial pressure of water vapor in the gas being measured, which is directly related to the dew-point temperature.

## 1.6 Measurement Units

The Promet EExd offers complete flexibility for the user to select their preference of hygrometric units. Integral pressure measurement enables unit conversions from dew point to moisture content, or dew point to dew point for different pressure conditions.

The available units of dew point/moisture content are as follows:

### Dew-Point Temperature

- °C or °F dew point
- °C or °F dew point calculated for a set pressure level input by the user, for either ideal or natural gas

### Moisture Content (parts per million)

- ppm<sub>v</sub> for ideal gas (Ppm(v) IG)
- ppm<sub>v</sub> for natural gas (Ppm(v) NG)

### Moisture Content (pounds per million standard cubic feet)

- lb/MMscf for natural gas (LBMMSCF)

### Milligrams per normal cubic meter

- mg/m<sup>3</sup> natural gas (mgm-3)

The firmware of the Promet EExd incorporates conversion data for ideal gases and natural gas. For natural gas the conversions are performed based on the long established IGT Research Bulletin No. 8 or the recently published ISO 18453, to customer order preference.

## 1.7 Elimination of Temperature Effects

To ensure continuous optimum analysis conditions the Promet EExd Main Unit is temperature controlled (internally) at a stable level. The control temperature level is selected to suit the climate at the point of installation, being set to the normal maximum temperature. Such steady state control within the analyzer greatly reduces the effects of diurnal (day-night) swings in temperature. These temperature changes could induce transitional adsorption and desorption effects of the flowing sample, resulting in erroneous measurements.

In addition, the Promet EExd utilizes an advanced temperature compensation algorithm that automatically maintains best possible measurement accuracy in the event of heater failure or if the prevailing climate exceeds the set temperature level.

## 1.8 Calibration Maintenance

Maintenance of calibration is essential to the lifetime performance of all analyzers. To ensure that all customers worldwide can maintain the performance of their Promet EExd, the unique Michell Calibration Exchange Service offers freshly calibrated replacement Ceramic Metal-Oxide Moisture Sensors certified traceable to NPL and NIST. As the calibration characterization data for each Promet EExd Sensor is programmed into on-board non-volatile memory, fitment of the Calibration Exchange Sensor refreshes the calibration, returning the measurement performance to day-one with down-time of only a few minutes while the interchange is made. No programming or data input is required by the user to complete this. The calibration exchange is available globally on swift delivery, typically less than two weeks, and at the same or less than the cost of a traditional 'return to manufacturer' re-calibration service.

The recommended calibration maintenance interval is 12 months for sweet gases and 6 months for sour gases.

Michell recognises that some customers wish to carry out their own calibration adjustments in the field using either a portable dew-point generator (ATSM D5454), or against a calibrated reference hygrometer or certified moisture-in-gas cylinders. The Promet EExd accommodates all such needs within the operating firmware that offers user-friendly access to the calibration characterization table for re-calibration adjustments to be made at just one point (for example, using a certified cylinder gas) or multiple points (using a field generator) across the measurement range.

## 1.9 Promet EExd Sampling System

(Optional – see separate manual if you have purchased this item)



**Figure 1** *Promet EExd Sampling System*

Good sample conditioning and handling is particularly important in the field of moisture measurement. As the moisture sensor has to be exposed directly to the process liquid stream in order to detect the dissolved moisture present, key sampling issues such as the avoidance of particulate contamination are imperative to successful operation. Michell's 30 years of expertise in on-line process moisture analyzers are used to optimize the design of the Promet EExd Sampling Systems.

Contact Michell Instruments for further details: [www.michell.com](http://www.michell.com).

## 2 INSTALLATION

### 2.1 Electrical Safety

**WARNING:**  
During the installation of this product ensure that all applicable national and local electrical safety regulations are observed.



**WARNING:**  
Isolate the power prior to installation.

**WARNING:**  
Always ensure that power is switched off prior to accessing the product for any purpose other than normal operation or prior to disconnecting any cables.

#### 2.1.1 Equipment Ratings and Installation Details

The following mandatory statements refer to the Ex certified Promet EExd Analyzer only (not including the sampling system).

This equipment must be supplied with a voltage between the range of 90 to 260 V AC, 47/63 Hz. Maximum power rating is 180 W.

The power is connected via PL1 on the mains connector PCB.



**Figure 2** *Power Connection Connector*

All input and output connectors are 2-part PCB mounted type, rated at 300 V 10 A.

The detachable, screw terminal half of each connector is designed to accept 0.5...2.5mm<sup>2</sup> [24 -12 AWG] stranded or solid conductors.

Any power connection cable should be 3 core over sleeved, with minimum 0.5mm insulation and rated at 300 V. Cables should have Live (L), Neutral (N) and Earth [Ground] (E) conductors. Ensure suitably rated power supply cables and glands are used to ensure that electrical safety is maintained. Connect each of the Live (L), Neutral (N) and Earth [Ground] (E) conductors to the similarly marked terminals (L, N, E) on the Power In connector shown in Figure 3 above. Ensure the power supply can deliver sufficient power consumption requirement.

Any power supply terminals and voltages must be suitably separated from the other I/O requirements of this product.

Before applying power, perform a continuity test to ensure that the power supply cable and product are effectively connected to the protective Earth.

The Protective Earth terminal is mounted internally and the Earth wire connected to it should never be disconnected. The product enclosure is supplied with an external earth stud at the lower right hand side. At installation, connect this earth stud to plant earth by a minimum 4mm<sup>2</sup> earthing bonding. M6 stud and 2 off M6 nuts and washers, all nickel plated.



**Figure 3** *Earthing Stud And Nut Washer Assembly*

Fuse: A replacement fuse can be obtained by contacting Michell Instruments' technical support. Fuse rating = 5 x 20mm 2.5 A anti-surge to IEC 60127-2.

This product is designed to be safe at least under the following conditions: between a temperature range of -40...+60 °C (-40...+148 °F), in maximum 80% relative humidity for temperatures up to +31 °C (+88 °F) decreasing linearly to 50 %rh at +50 °C (+122 °F). Supply voltages of ±10% and transient over voltages up to Overvoltage Category II. Pollution Degree 2. Altitudes up to 2000m. Outdoor mounting is permitted using suitably rated glands equivalent to NEMA 4/IP66. **See Appendix A, Technical Specification, for full operating parameters.**

Do not remove or exchange any of the cables or electrical components supplied with this product. Doing so will invalidate all warranties.

There are no additional or special electrical safety requirements other than those referred to in this manual.

Location and mounting arrangements – refer to the relevant sections of this manual for the location and mounting details.

Installation of this equipment must include the provision of a suitable and locally positioned power isolation switch or circuit breaker. Indication of the purpose of the switch or circuit breaker is strongly recommended. An over-current protection device should be rated to a maximum of 10 A.

This equipment and all power isolation devices must be installed in a location and position that allows safe and easy access to their operation and is able to rigidly support the equipment.

Do not install this equipment in a location that would expose it to impact or high levels of vibration.

Operation of this equipment, other than in a manner specified by the manufacturer, may impair the safety protections provided.

The safe installation of this equipment and any system incorporating this equipment is the responsibility of the installer. Ensure local regulations and requirements are referred to prior to any installation commencing.

**2.2 Hazardous Area Safety**

Refer to Appendix F for the Hazardous Area Certification of this product.

This product is fitted with a marking label that contains Hazardous Area information pertinent to the suitable location and installation.

During all installation and operation activities, local regulations and permitted working routines must be observed. Installation should only be performed by competent personnel and in accordance with the latest version of IEC/EN60079-14 or local equivalent.

Repair and servicing of this equipment must only be carried out by the manufacturer.

An Installation and Maintenance Information Sheet is supplied separately to the manual.



**WARNING:**  
**This product is certified safe for use in a Zone 1 and Zone 2 area only. This product must not be installed or used within a Zone 0 area.**

**WARNING:**  
**This product must not be operated within an explosive atmosphere greater than 1.1 bara.**

**WARNING:**  
**This product must not be operated with enriched oxygen gas samples (more than 21% oxygen content).**

**WARNING:**  
**This product should not be operated outside its certified temperature range. Check the attached instrument marking plate for the appropriate information.**

**WARNING:**  
**The enclosure of this product provides Exd protection, partly through the threads used for mounting the lid, stopping plugs and cable gland. At all times effort should be made to ensure these threads are suitably protected from damage and that only appropriately rated mating parts are applied to them, in accordance with the certifying requirements.**

## 2.3 Pressure Safety



**WARNING:**  
**This product is used in conjunction with pressurized gases.**  
**Observe pressurized gas handling precautions.**



**WARNING:**  
**Pressurized gas is dangerous.**  
**Pressurized gas should only be handled by suitably trained personnel.**

This product requires pressurized gas to be connected to it. Observe pressurized gas handling regulations. Only suitably trained personnel should carry out tasks that include the use of pressurized gas mediums.

## 2.4 Lifting and Handling



**WARNING:**  
**This instrument is in excess of 18 kg.**  
**Personnel must observe suitable lifting and handling precautions.**

This product is not designed as portable or transportable equipment. It should be rigidly fixed in position as per the full installation instructions.

The weight of the analyzer is in excess of 18 kg. Therefore, appropriate lifting and handling techniques should be used during the installation process. Before commencing any lifting or handling ensure that its intended location is suitable and appropriately prepared. Make sure that mounting point design considerations have employed locally approved safety factors.

When handling and installing this product (particularly after removal from its packaging) ensure that it is not dropped, impacted or subjected to high levels of vibration or environmental conditions that may impair its operation.

**2.5 Analyzer System**

Refer to the Installation & Maintenance Information sheet (supplied separately) and the System Drawings in Appendix A.

The instrument is housed in an aluminum EExd enclosure suitable for wall or panel mounting. Four mounting points are available with M12 clearance holes on fixing centres of X = 270mm x Y = 318mm.

- Height: 355mm (13.9")  
500mm (19.68") including installation clearance
- Width: 310mm (12.20")  
500mm (19.68") including installation clearance
- Depth: 245mm (9.64")

The enclosure provides environmental ingress protection IP66 and should be mounted vertically in a location free of any appreciable vibration. It should be placed in a shaded position to prevent heating effects through sun radiation.

The weight of the analyzer is 21 kg (46 lbs).

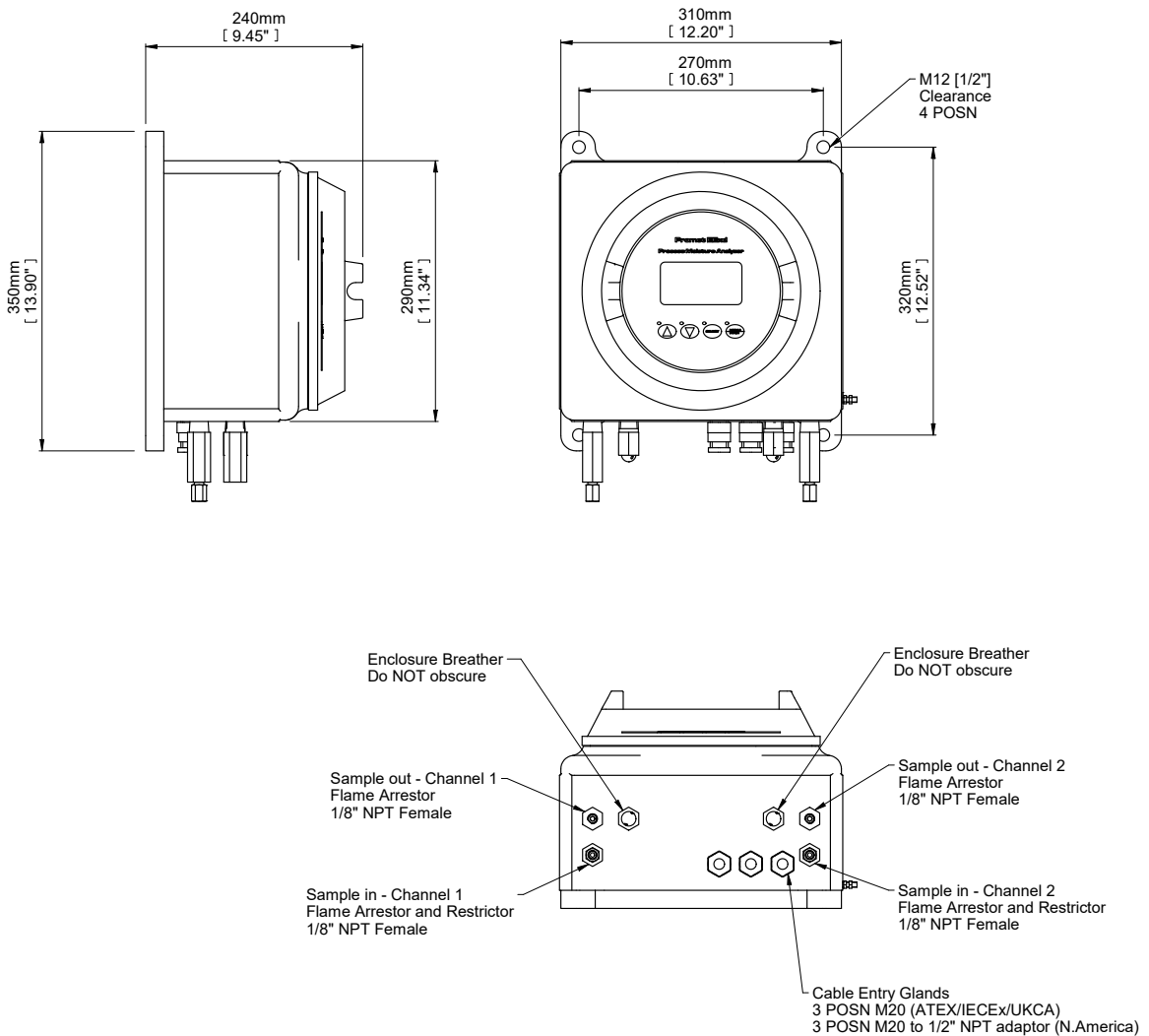

**Figure 4** Promet EExd Mounting Drawing

2.5.1 Pipework

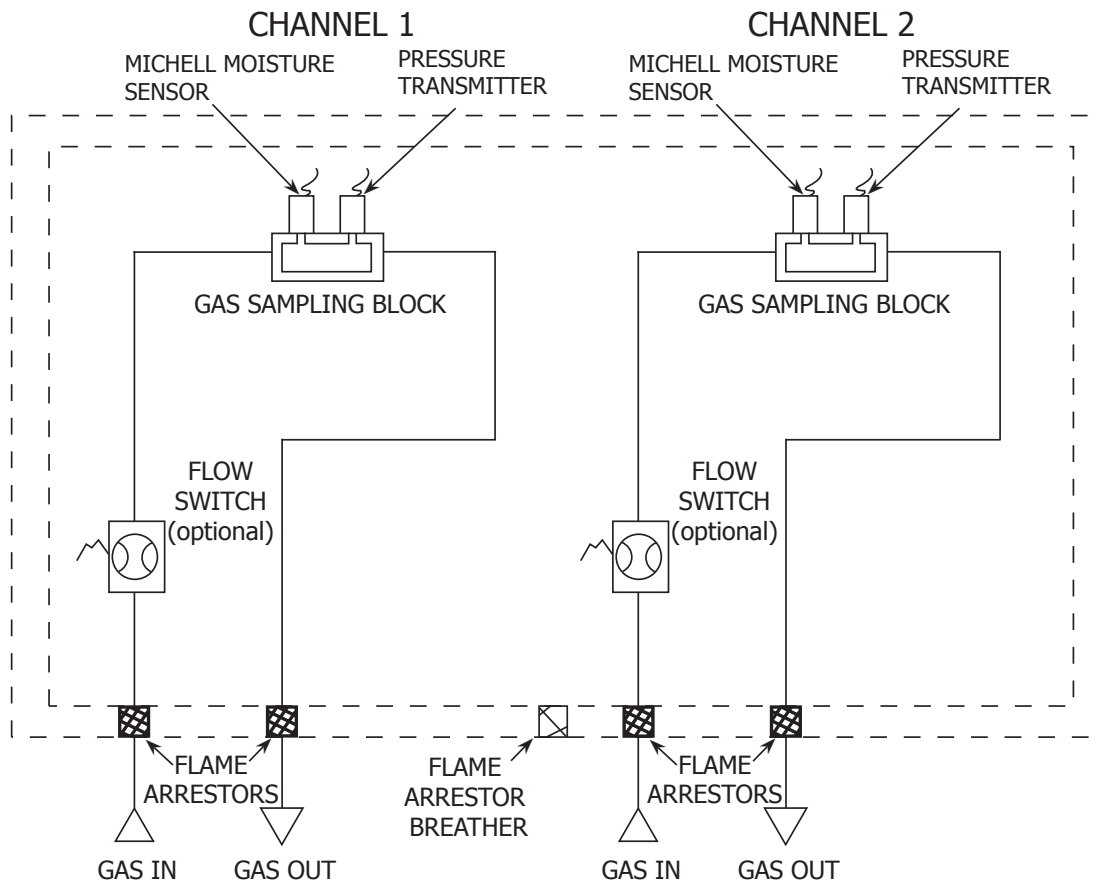

Figure 5 Pipework Connections

**NOTE: Ensure that the process sample gas supply line is well flushed through to clear any liquids and debris present prior to connection to the instrument. A sample handling system must prepare the gas in terms of pressure regulation and filtration before entering into the measurement system.**

In accordance with the Certification requirements, the Promet EExd must have, as a minimum, the components described in Figure 7.

The pipework connections are as follows:

<b>Water dew-point Channel 1 Gas Sample inlet</b> (Maximum pressure of 138 barg (2000 psig))	1/8" NPT(F)
<b>Water dew-point Channel 1 Gas Sample outlet</b> (Vent to atmosphere or low pressure flare line)	
<b>Water dew-point Channel 2 Gas Sample inlet</b> (Maximum pressure of 138 barg (2000 psig))	
<b>Water dew-point Channel 2 Gas Sample outlet</b> (Vent to atmosphere or low pressure flare line)	

The following points should be considered when installing the sample gas supply line:

PTFE tape is recommended for pipe connections. Solvent based pipe thread sealant should not be used, as condensable components or contaminants can be leached during the curing period.

It is recommended that Viton is used for all O-rings.

Care and attention to the position and installation of the piping will minimize problems caused by avoidable contamination of the measurement system. The most common cause of difficulty is the accumulation of liquid in impulse lines during a shutdown period. If the measurement system has not been isolated on restart-up, condensate can be displaced into components and associated pipe work within the measurement system.

If this event follows a period when process lines may have been contaminated by non-hydrocarbons, e.g. glycol, corrosion inhibitors, etc., the problem is magnified. Similarly, difficulty will be encountered in sample gases carrying liquids, including hydrocarbon liquids.

Our recommendations are:

- The sampling point on the process line should be on the top of the pipe. If a radial probe is used, the orifice should face downstream. Sample should be taken from middle 1/3 pipe internal diameter.
- The internal volume of the impulse tubing between the process line and any sampling system should be as low as possible (sample lines should be kept as short as possible) to minimize response lag time to changing process conditions.
- Piping should be lagged and/or trace heated if ambient temperatures could cause the sample gas to fall below its dew-point temperature.
- A drain valve should be placed at the low point (if any) in the system.
- It should be standard procedure to isolate the measurement system during shutdowns or when plant problems are being experienced. The supply lines must be fully purged before restarting.
- The relatively large area of surfaces and internal volume of pressure regulators can be particularly troublesome if contamination is experienced. Prolonged purging with gas may be necessary to remove the contamination. Stripping and cleaning, followed by purging of the system, is preferred.
- Avoid sample gas streams that are already very close to the dew point or which have dispersed liquid (not necessarily hydrocarbon) burden. In such cases, sampling from fast loops and/or from downstream of existing catch pot/coalesce systems is always preferred.

**NOTE: Failure to observe these recommendations will potentially cause problems of contamination as well as causing consequential inaccurate, unreliable and inconsistent monitoring. If a top-entry sample point is not available, extra attention should be given to the design of the sample line installation to avoid unwanted contamination.**

2.5.2 Power Connection

A single-phase AC power connection is required.

The power supply can accommodate voltages from 90 to 260 V AC, 47/63 Hz. The unit requires a maximum of 180 W to function correctly.

The connection is made via a two-part connector mounted at the base of the unit. See Appendix A.

Cable entry into the measurement system is made through the bottom of the enclosure.

- For ATEX/IECEX/UKCA compliant versions of the product, 3 off ISO M20 tapped holes are provided
- For cQPSus compliant version of the product, 3 off 1/2" NPT entries are provided

**NOTE: For ATEX/IECEX/UKCA installations EExd Stopping Glands MUST be used when installing. Refer to the separate Installation & Maintenance Information sheet supplied.**

The terminals are marked:

- L = Live
- N = Neutral
- E = Earth

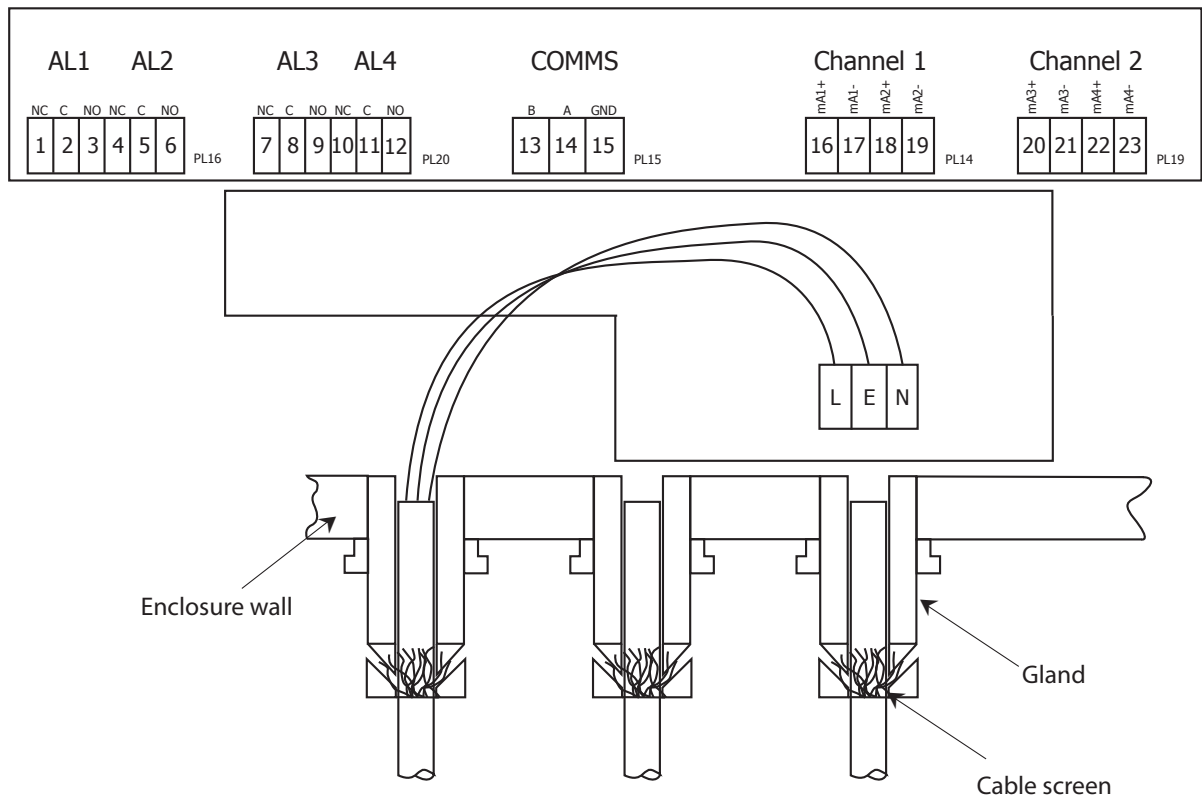

Figure 6 Hook-up Wiring Diagram

### 2.5.3 Analog and Digital Communications

Two active 4...20 mA outputs and a Modbus RS485 digital interface (see Appendix E for details) are provided with the Promet EExd. mA1 and mA3 output the moisture values. mA2 and mA4 output the pressure values of Channels 1 & 2 respectively.

**NOTE: The maximum output resistance for the 4...20 mA outputs is 500Ω.**

See Section 3.7 for setting the 4...20 mA outputs via the user interface and Appendix E for setting the outputs via the Modbus interface.

Refer to Figure 6 for cable wiring.

### 2.5.4 Process Alarms and Analyzer Status Alarms

Each channel has an associated process and fault alarm, as shown below:

- AL1: Channel 1 process alarm
- AL2: Channel 1 fault alarm
- AL3: Channel 2 process alarm
- AL4: Channel 2 fault alarm

Each alarm relay features Normally Open (N/O), Normally Closed (N/C) and Common (C) contacts.

The process alarm contacts change state when the moisture value is greater than the alarm set point.

The fault alarm contacts change state when an error associated with the channel occurs, or when there is a supply failure.

## 2.6 Promet EExd Start-Up Purge Procedure

**This is a mandatory procedure stipulated in the ATEX/IECEX/UKCA certification of the product. The procedure must be fully carried out prior to the Promet EExd having any power or signal connections applied. It must also be fully carried out after the Promet EExd and associated gas handling equipment has been installed and leak checked. Always refer to Appendix F.4 – Special Conditions of Safe Use.**



**This procedure must be carried out at any time following service or maintenance periods that cause any of the Promet EExd or associated gas handling equipment pipe work to be disconnected.**

**It is not necessary to carry out this procedure if power or signal connections only have been disconnected.**

1. Before start-up, ensure that all power and signal connections to the Promet EExd are fully isolated
2. Ensure that all Inlet & Outlet gas connections to the Promet EExd are made correctly and are leak tight checked.
3. Fully open the flow control valve of the flow meter of each channel.
4. Fully open the sample gas inlet isolation valves.
5. Adjust open the pressure regulators until full scale flow is observed on each of the water dew-point channels.
6. Allow the sample gas to purge the system for the period of time indicated in the table below:

**TOTAL PURGE TIME  
must be a minimum of 1 minute at 1 NI/min (2.1 scfh)**

Assumes total system pipe length is 3m (9.8') and internal pipe bore is the recommended 4mm (0.16") internal bore.

For every additional 1m (3.3') of pipe work, continue the Gas Purge for an additional 15 seconds at 1 NI/min (2.1 scfh).

7. After the appropriate purge duration, close the gas inlet isolation valve.
8. Ensure the window is replaced and fully secured before applying the power.

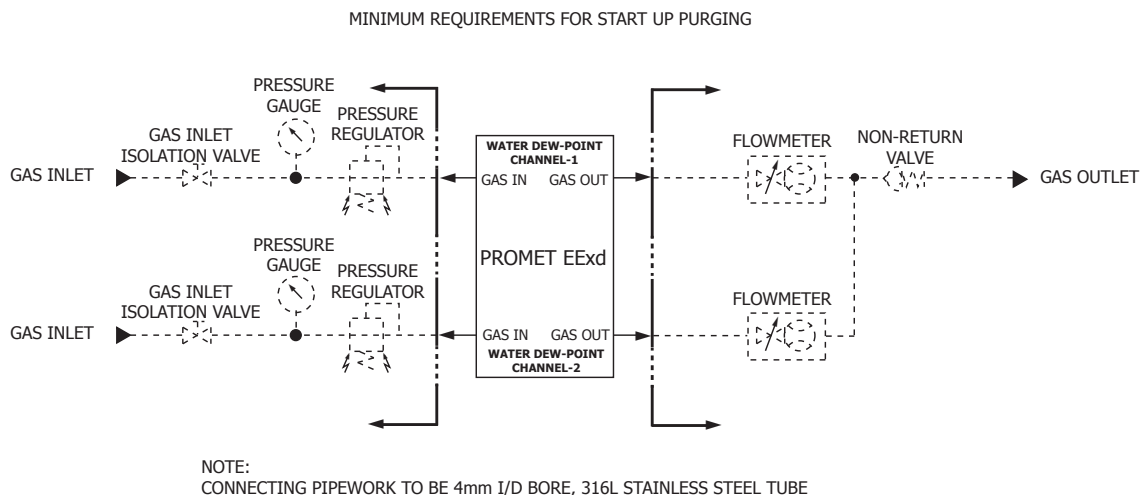

**Figure 7** Minimum Requirements for Start-up Purging

## 2.7 Sample Gas Flows

The flow through each channel should be set at approximately 1 NI/min (2.1 scfh). This flow setting figure is not required to be precise. Its purpose is only to ensure that a representative sample of gas is presented to the measurement sensor.

To increase the speed of response of the measurement of the main process gas it is highly recommended that a fast bypass loop be installed into the gas sampling system. The recommended flow through the bypass loop should be approximately 5 times that of the measurement channel. Therefore, typically, the bypass gas flow should be set to approximately 5 NI/min (10.6 scfh).

## 2.8 Sample Flow Alarms (Optional)

The optional flow switches are supplied to alert the user to either severely reduced or discontinuation of the sample gas flow through the system. An alarm state will be indicated on the error message line at the bottom of the MAIN Page. See Section 4.4 on troubleshooting for further details.

When the flow of sample gas is set correctly, the alarm states will be indicated when the gas flows have lowered into a range deemed unsuitable for effective measurements to be made.

The flow switches are adjusted during factory test to activate the alarm when the flow falls below approximately 10 to 20% of the normal recommended sample flow setting (see Section 2.7). During the factory setting procedure the gas pressure that is applied represents the most common application analysis conditions for water dew-point sensors (68 barg/986 psig or 50 barg/725 psig). The operation of these variable area flow switches are influenced by pressure. For increased pressure the flow alarm activation point will be at a higher flow rate and conversely, for reduced pressure, the activation point will be at a lower rate. These devices exhibit a hysteresis that may require a flow of greater than 100% of the recommended flow setting for a brief period in order to clear the alarm condition.

**NOTE: If the Promet EExd is going to be operating with significantly different analysis pressures to those used during factory testing then fine re-adjustment of the flow switches may be beneficial to suit the application conditions. If this is the case, contact Michell Instruments ([www.michell.com](http://www.michell.com)) for guidance on how adjustments can be made on site.**

### 3 OPERATION

#### 3.1 System Operation

At switch-on, the instrument will display the MAIN Page. It will synchronise itself to the on-board real time clock, in order to begin logging data at the next minute that is a multiple of 5 i.e. 5, 10, 15 etc. The MAIN Page will show the moisture and pressure readings of either 1 or 2 sensors and a countdown to the time when it will take the next data log. Figure 9 shows the MAIN Page for both 1 and 2 sensor configurations. Pressing the **MENU/MAIN** button from this page will take you to the MAIN MENU Page (see Section 3.4).



**Figure 8** MAIN Page in Single Channel (top) and Dual Channel Modes

#### 3.2 User Interface

##### 3.2.1 Interface Controls

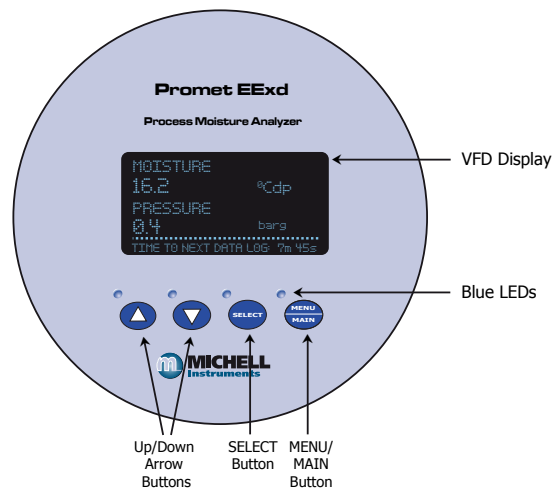

**Figure 9** User Interface

Figure 10 illustrates the user interface. It has a vacuum fluorescent display and four touch sensitive pads that facilitate user interaction through the glass of the enclosure.

### 3.2.2 'Up/Down Arrow' Buttons

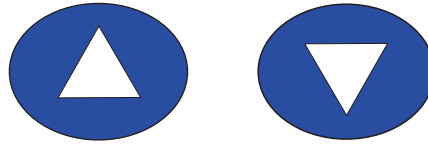

**Figure 10** *Up/Down Arrow Buttons*

The **Up** (▲) and **Down** (▼) buttons are used to change pages, scroll through lists and adjust values.

### 3.2.3 'SELECT' Button



**Figure 11** *'SELECT' Button*

The **SELECT** button is used to select or de-select a highlighted item in a menu list.

### 3.2.4 'MENU/MAIN' Button

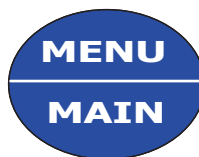
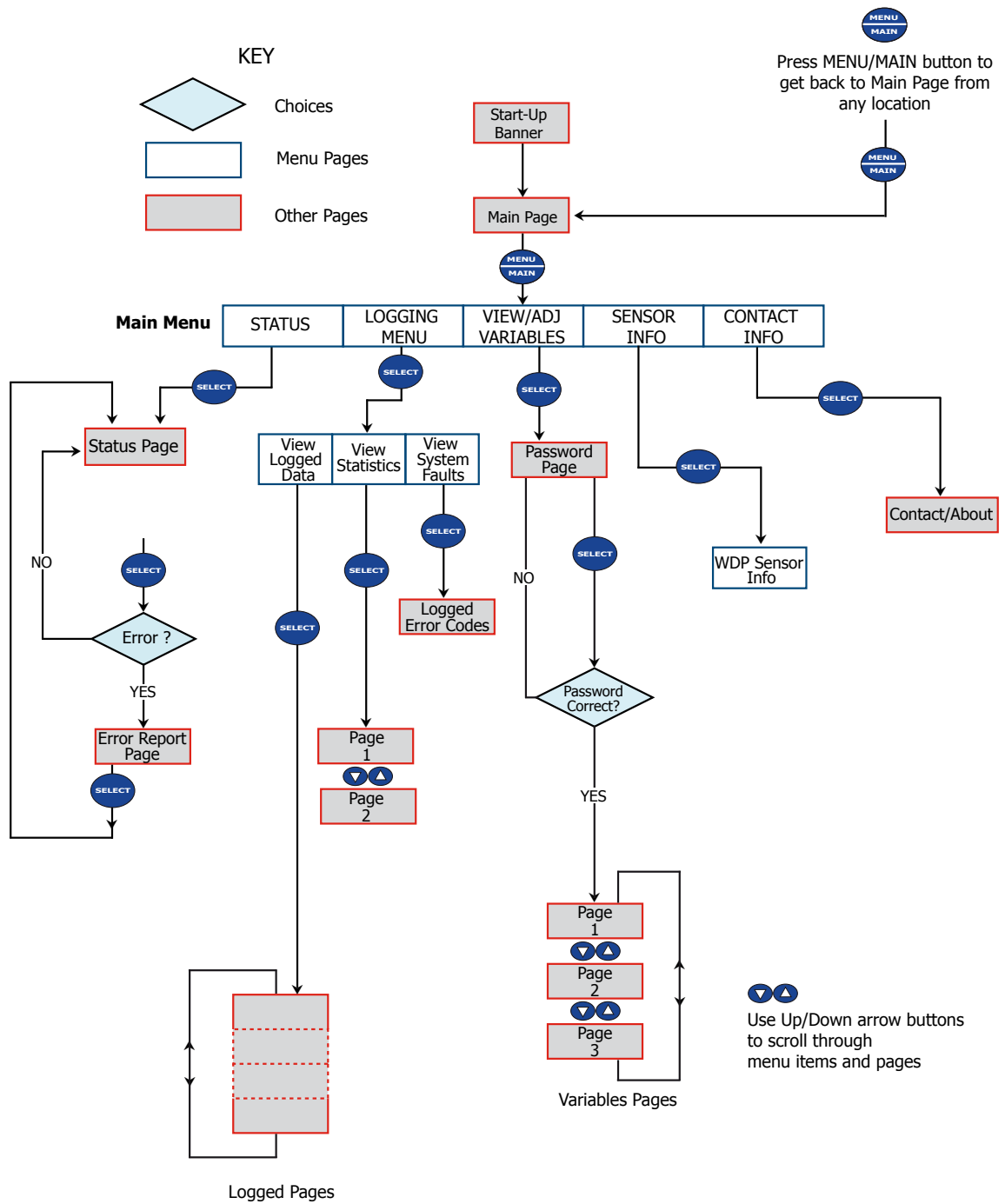

**Figure 12** *'MENU/MAIN' Button*

The **MENU/MAIN** button is used to toggle between the MAIN Page and the MAIN MENU Page, or return to the MAIN Page from any location within the menu structure.

### 3.3 Menu Structure

Figure 14 shows a map of the menu structure.



**Figure 13** Menu Structure

### 3.4 MAIN MENU Page

This page is accessed by pressing the **MAIN/MENU** button from the MAIN Page. The instrument's status, variables, logged data and system information are available through this page. Use the **Up** (▲) and **Down** (▼) buttons to highlight the page of interest and press the **SELECT** button to access.

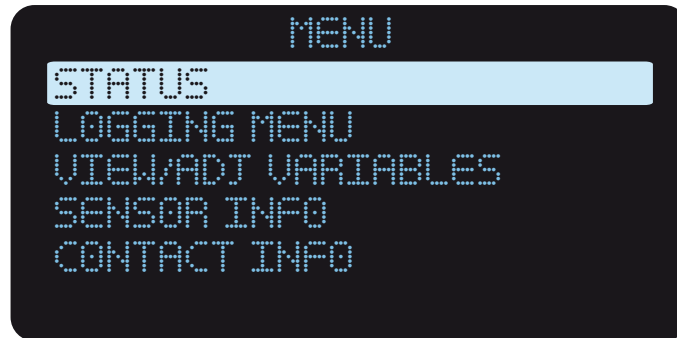

**Figure 14** *MAIN MENU Page*

### 3.5 STATUS Page

This page shows the status of the process alarm and flow for one or both channels, depending upon the configuration. When the measured moisture value rises above the alarm set-point, the moisture alarm condition will be displayed as **ON\*ALERT\***. No flow is displayed as **OFF\*ALERT\***.

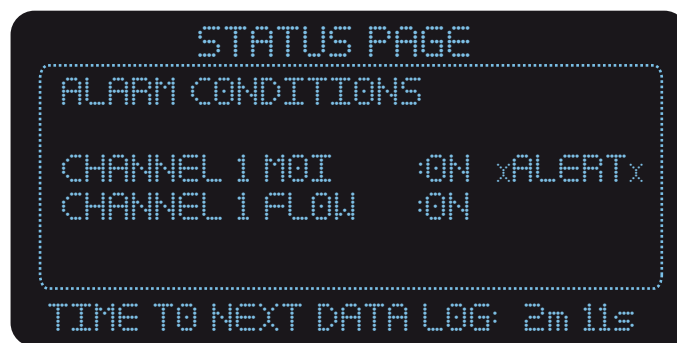

**Figure 15** *STATUS Page*

Press the **MAIN/MENU** button to return to the MAIN Page.

### 3.6 LOGGING MENU Page

This page allows the viewing of data or statistical information on the logged data. Press the **SELECT** button to see the following options:

**View Logged Data**

**View Statistics**

**View System Faults**

Press the **Up** (▲) and **Down** (▼) buttons and the **SELECT** button to enter these options pages.

If there is no data available then **No Data Available** will be displayed and no access will be given to the other two options.

#### 3.6.1 VIEW LOGGED DATA Page

This page allows access to the previous measurement results made by the instrument. A rolling total of a maximum of 150 samples can be logged, which represents a measurement history of 150 x (measurement time) in minutes. Sample 1 represents the most recent measurement taken. After 150 measurements have been logged, the oldest measurement will be deleted and replaced as each new measurement is logged. **Caution: Changing the moisture value, e.g. from dew point to ppm, will result in the loss of all logged data.**

Access to each measurement sample is via the **Up** (▲) and **Down** (▼) buttons, which may be used to scroll through each page of information. If faster scrolling is required (to quickly move to another sample) press the **SELECT** button and the sample number will increase by 10. When the sample number selected is greater than that acquired, or is greater than 150, Sample 1 will be selected and displayed.

Sample Number	Time of Sample	Date (day/month)
LOGGED DATA		
NO. 1	10:20	29/05
MOI	6.2	°Cdp
PRES	0.2	barg

**Figure 16** LOGGED DATA Page

Each page of logged data contains:

- Sample number 1 to 150, 1 being the most recent
- Date of sample dd/mm
- Time of sample 24 hr format, hh:mm
- The values of Moisture content/Dew point and Pressure for 1 or 2 channels
- The units of measurement

Press the **MAIN/MENU** button to return to the MAIN Page.

### 3.6.2 VIEW STATISTICS Page

These pages display the maximum, minimum and average values for each measured parameter for up to 150 previous measurement samples. **RESET LOG** on the MAIN MENU Page re-sets the logging statistics.

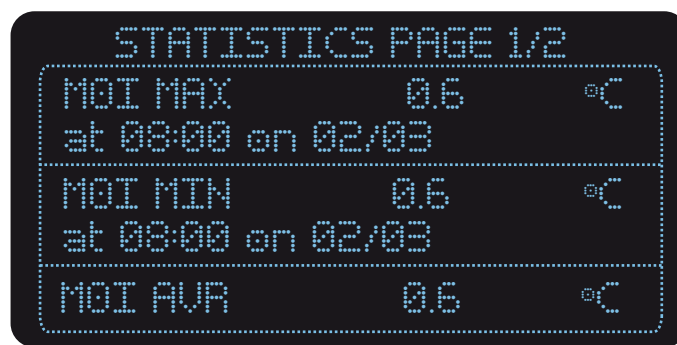

**Figure 17** STATISTICS Page

Use the **Up** (▲) and **Down** (▼) buttons to scroll through the statistics.

Press the **MAIN/MENU** button to return to the MAIN Page.

### 3.6.3 VIEW SYSTEM FAULTS Page

This page displays a record of the last six system faults that have occurred and have subsequently been corrected. This assists in the diagnosis of any past anomaly in measured values. Any present system faults will be displayed in the bottom message line of the MAIN Page.



**Figure 18** LOGGED ERROR Page

Refer to Section 4.4 for descriptions of the error messages and codes.

Press the MAIN/MENU button to return to the MAIN Page.

## 3.7 VIEW/ADJ VARIABLES Page

For more information on each variable refer to Appendix B.

### 3.7.1 Password

To safeguard against unauthorized adjustment of set-up parameters and variables, an entry lock is provided.

The user must first input the access code to enter the VIEW/ADJ VARIABLES Pages.

The password is: 7316

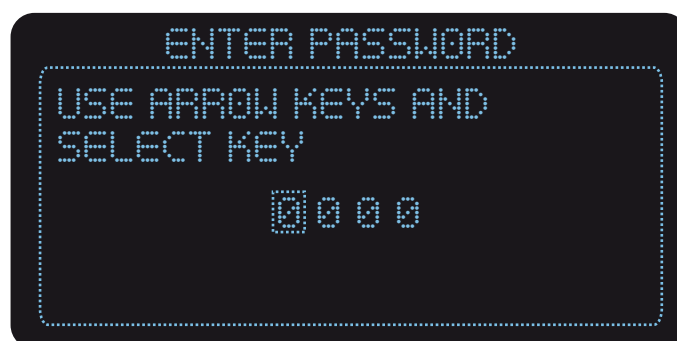

**Figure 19** PASSWORD Page

Use the Up (▲) and Down (▼) buttons to change the highlighted digit and press the SELECT button to enter and move to the next digit. Inputting 4 correct digits will result in access to the VARIABLES Pages as detailed in the following sections.

### 3.7.2 VARIABLES Pages

Three pages (four pages in the dual channel configuration) are used to display the system variables. They can be adjusted by using the **Up** (▲), **Down** (▼) and **SELECT** buttons.

Use the **Up** (▲) and **Down** (▼) buttons to scroll through the list and from page to page. To select a variable for adjustment, scroll to the desired variable and press the **SELECT** button. A small box will appear beside the value to indicate that it can be adjusted. Use the **Up** (▲) and **Down** (▼) buttons to change the value. **NOTE: Numerical values can be changed at a faster rate by extending the duration of the Up (▲) and Down (▼) button press.**

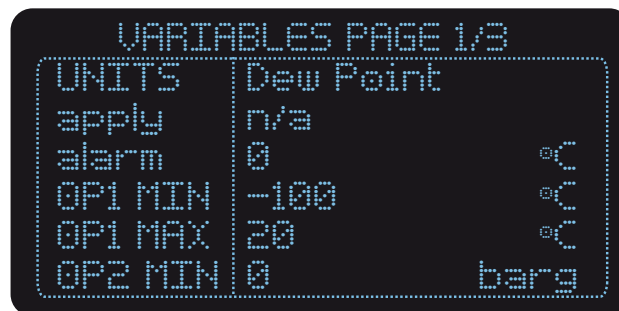

Figure 20 VARIABLES Page

### 3.7.3 Single Channel Configuration VARIABLES Pages

For more information on each variable refer to Appendix B

#### VARIABLES Page 1

Variable	Brief Description
UNITS	Moisture measurement
apply	Used for calculating dew point at an applied pressure for ideal or natural gas
alarm	Moisture value that trips the process alarm
OP1min	Moisture value that gives 4 mA on mA1 output
OP1max	Moisture value that gives 20 mA on mA1 output
OP2min	Dew-point or Pressure value that gives 4 mA on mA2 output

**VARIABLES Page 2**

Variable	Brief Description
OP2max	Dew-point or Pressure value that gives 20 mA on mA2 output
°C/°F	Temperature units selection
Pressure	Pressure units selection
TIME	System time
DATE	System date
OP2/4 PARAM	Adjustable range/options: Measured Dew point, Pressure

**VARIABLES Page 3**

Variable	Brief Description
LOG INT'VAL	Time interval between data logs
RESET LOG	Clears the logged data
INST ADDR	Sets the instrument address
INT TEMP SP	Set-point temperature of the internal heater
SET DEFAULT	Sets the system defaults

**3.7.4 Dual Channel Configuration VARIABLES Pages**

For more information on each variable refer to Appendix B

**VARIABLES Page 1**

Variable	Brief Description
CHN1	Moisture measurement for Channel 1
apply	Used for calculating dew point at an applied pressure for ideal or natural gas
alarm	Moisture value that trips the process alarm for Channel 1
CHN2	Moisture measurement for Channel 2
apply	Used for calculating dew point at an applied pressure for ideal or natural gas
alarm	Moisture value that trips the process alarm for Channel 2

**VARIABLES Page 2**

Variable	Brief Description
OP1min	Moisture value that gives 4 mA on mA1 output
OP1max	Moisture value that gives 20 mA on mA1 output
OP2min	Dew-point or Pressure value that gives 4 mA on mA2 output
OP2max	Dew-point or Pressure value that gives 20 mA on mA2 output
OP3min	Moisture value that gives 4 mA on mA3 output
OP3max	Moisture value that gives 20 mA on mA3 output

**VARIABLES Page 3**

Variable	Brief Description
OP4min	Dew-point or Pressure value that gives 4 mA on mA4 output
OP4max	Dew-point or Pressure value that gives 20 mA on mA4 output
°C/°F	Temperature units selection
Pressure	Pressure units selection
TIME	System time
DATE	System date

**VARIABLES Page 4**

Variable	Brief Description
OP2/4 PARAM	Adjustable range/options: Measured Dew point, Pressure
SET DEFAULT	Set the system defaults
LOG INT'VAL	Time interval between data logs
RESET LOG	Clears the logged data
INST ADDR	Sets the instrument address
INT TEMP SP	Set-point temperature of the internal heater

**3.8 SENSOR INFO Page**

This page contains the information relating to the water dew-point sensors.

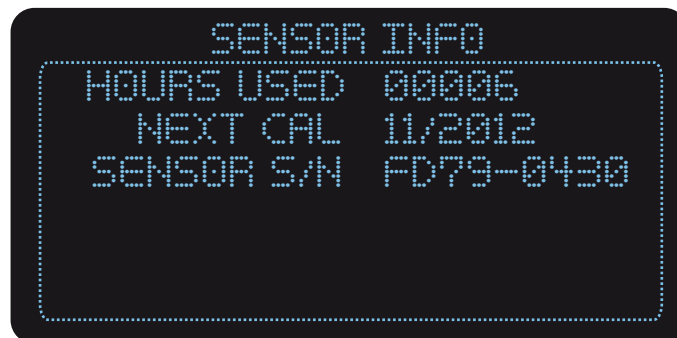

**Figure 21** *SENSOR INFO Page*

Hours Used	Duration that the sensor has been in active use
Next Cal	Next recommended calibration date of sensor
Sensor S/N	Serial number of sensor

### 3.9 CONTACT INFO Page

This page contains contact information for Michell Instruments.



**Figure 22** *CONTACT INFO Page*

## 4 MAINTENANCE



**The power to the enclosure must be turned off before any work is carried out in the measurement system enclosure. Observe de-energize durations.**

**Gas line connections to the measurement system must be isolated and de-pressurized before any work commences.**



**Before powering up the instrument the "Start-Up Purge Procedure" must be carried out. See Section 2.6.**

**To ensure the full requirement of this product's safety certificate is maintained, any loosened or disturbed tubework or couplings must be subject to a gas pressure test and appropriate leak check at 1.5x the max operating pressure before the full product is re-energized.**

The design of the Promet EExd sensor cell and measurement system is such that no specific routine maintenance is required. If, however, a fault does occur with your system that is not covered within this manual please contact Michell Instruments ([www.michell.com](http://www.michell.com)) or your local representative.

### 4.1 Enclosure Cover and User Interface

The enclosure cover is part of the flameproof protection for the enclosure and has an IP66 rating. It should be firmly closed to ensure flameproof integrity and continued environmental protection. For prolonged and easy operation ensure that the threads are always lubricated with a light grease. A grub screw is used as a locking device. This should be loosened before unscrewing the cover counter-clockwise.

The user interface assembly uses two ¼ turn bayonet style fasteners to secure it. These are finger operated and should be turned clockwise to lock and counter-clockwise to release. The user interface, once disconnected from the two ¼ turn fasteners, can be temporarily re-positioned on the instrument by securing the right-hand fastener in the left-hand mount. This will situate the interface assembly in an overhanging position outside of the enclosure allowing greater access. If there is insufficient space to accommodate the overhanging user interface assembly on the left-hand side, it may be rotated 180° (upside down) and placed on the right-hand side.



**Figure 23** *Ribbon Cable Connection*

Always keep the bayonet fittings lightly lubricated. If required, the user interface can be fully disconnected from the instrument by disconnecting the ribbon cable connection to the main processor PCB.



**All of the procedures below can only be carried out by first unscrewing the enclosure glass cover and removing the user interface assembly.**

## 4.2 Replacement of the Moisture Sensor Assembly



**The power to the enclosure must be turned off before any work is carried out in the measurement system enclosure. Observe de-energize durations.**

1. Isolate the incoming sample gas line by **CLOSING** the sample inlet isolation valve and allow the system to depressurize. Isolate the power and observe the de-energize duration.
2. Remove the enclosure window and mount the user interface (see Section 4.1).
3. Using a 2.5mm hex key remove the M3 cap head screw (1 in Figure 25) securing the water sensor assembly to the stay bracket.
4. Restrain the sensor assembly. Use a 11mm spanner to loosen and remove the 2 off 1/8" water dew-point sensor sample pipe connections (2 in Figure 25).

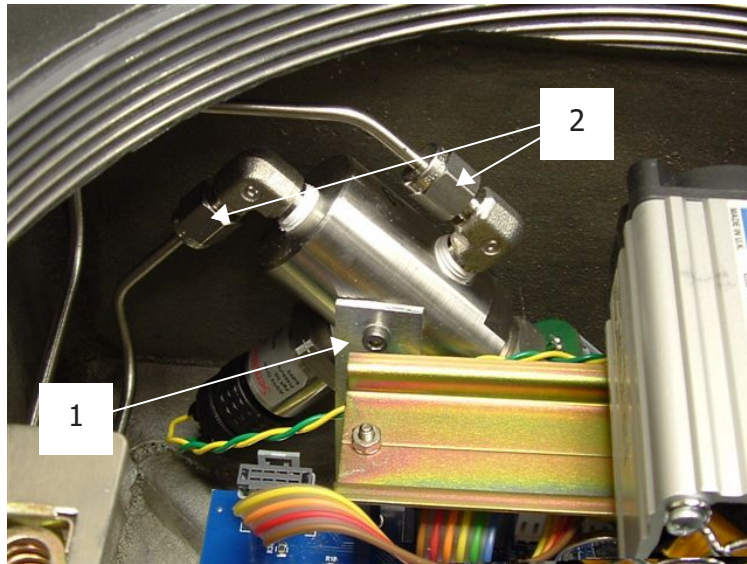

**Figure 24** *Moisture Sensor Assembly Replacement*

5. Carefully pull the sensor block assembly out of the enclosure. This will allow access to the two sensor connections and the pressure transducer connection.
6. Disconnect the ribbon cable connectors from the sensor pcb.
7. Unscrew the connector from the pressure transducer and fully remove the moisture sensor assembly from the enclosure.
8. Reconnect the sensor and pressure transducer connections to the replacement moisture sensor assembly. Reposition the assembly on the stay bracket and secure with the M3 cap head screw.
9. Refit and fully tighten the 1/8" water dew-point sensor sample pipe connections.
10. To ensure the full requirement of this product's safety certificate is maintained, any loosened or disturbed tubework or couplings must be subject to a gas pressure test and appropriate leak check at 1.5x the max operating pressure before the full product is re-energized.

### 4.3 Replacement of the Flow Switch (if fitted)



**The power to the enclosure must be turned off before any work is carried out in the measurement system enclosure. Observe de-energize durations.**

1. Isolate the incoming sample gas line by **CLOSING** the sample inlet isolation valve and allow the system to depressurize. **NOTE: Always refer to Appendix F.4 – Special Conditions of Safe Use.**
2. Remove the enclosure window and mount the user interface as shown in Section 4.1.
3. Restrain the flow switch assembly using an 11mm spanner to loosen and remove the 2 off 1/8" sample pipe connections.
4. Disconnect the 2-wire cable connector from the flow switch to the main circuit board.
5. Carefully pull the flow switch assembly out of the enclosure.
6. Replacement of the flow switch is simply a reversal of the above procedure.
7. To ensure the full requirement of this product's safety certificate is maintained, any loosened or disturbed tubework or couplings must be subject to a gas pressure test and appropriate leak check at 1.5x the max operating pressure before the full product is re-energized.

4.4 Troubleshooting

4.4.1 Error Messages

If a system errors occurs, an error message will appear at the bottom line of the MAIN Page describing the problem. If more than one system error has occurred, the error messages associated with those faults will continually scroll in turn.

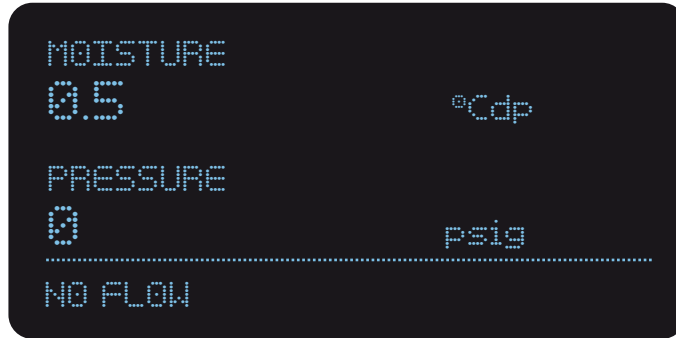

Figure 25 Error Message Line

Error Message	Description and Possible Cause
MOISTURE UNDER RANGE	Sensor tile failure
MOISTURE OVER RANGE	Sensor tile failure
TEMPERATURE ERROR	Temperature sensing device of the moisture sensor has failed
NO FLOW	No gas flow through sensor measurement cell – see Section 2.7
PRESSURE TRANSMITTER FAILURE	No pressure detected in the sensor measurement cell
CAL TABLE ERROR	Fault with sensor calibration data
LBMMSCF OUT OF RANGE	Calculation of moisture in natural gas cannot be calculated due to invalid inputs
INTERNAL HEATER FAULT	Fault with the internal temperature control

#### 4.4.2 Logged Error Codes

This page displays a record of the last six system error codes that have occurred in order to assist in the diagnosis of any past anomalies. Error codes are only logged at the end of every measurement cycle and indicate a change in status of single or multiple errors. For example, if an error code **0004** was logged this would indicate **CHANNEL 1 TEMPERATURE ERROR**. If an error code of **0000** was next logged this would indicate that the error had now cleared.



**Figure 26** *Logged Error Codes*

#### Logged Error Codes and Error Indication (Modbus Register 35)

Also see Appendix E: Register Configuration C, for more details

Error Code	Error Message
0000	All previous errors now cleared
0001	Channel 1 moisture sensor under range
0002	Channel 1 moisture sensor over range
0004	Channel 1 temperature device fault
0008	Channel 1 no flow
0010	Channel 1 pressure transmitter failure
0020	Channel 1 LBMMSCF calculation error
0040	Not used
0080	Channel 2 moisture sensor under range
0100	Channel 2 moisture sensor over range
0200	Channel 2 temperature device fault
0400	Channel 2 no flow
0800	Channel 2 pressure transmitter failure
1000	Channel 2 LBMMSCF calculation error
2000	Not used
4000	Internal heater fault

The 4 digit error codes are hexadecimal numbers that are dependent upon the bits set within the error indication register.

If more than one error has occurred, then the error codes will be added together, e.g.

- 1) Error Code **0104** =  
Error Code **0100** (Channel 2 sensor over range) plus  
Error Code **0004** ( Channel 1 temperature device fault) (**0100 + 0004 = 0104**)
  
- 2) Error Code **0C00** =  
Error Code **0800** (Channel 2 pressure transmitter fault) plus  
Error Code **0040** (Channel 2 no flow ) (**0800 + 0400 = 0C00**)

**NOTE : In hexadecimal**

**A = 10**

**B = 11**

**C = 12**

**D = 13**

**E = 14**

**F = 15**

#### **4.4.3 Analyzer Status Alarm Relay**

Each alarm relay features Normally Open (N/O), Normally Closed (N/C) and Common (C) contacts.

The process alarm contacts change state when the moisture value is greater than the alarm set point.

The fault alarm contacts change state when an error associated with the channel occurs, or when there is a supply failure.

# Appendix A

## Technical Specifications

## Appendix A Technical Specifications

<b>Main Unit – Measurement Parameters</b>	
Channel Configuration	Single and dual channel
Moisture Parameters	Dew point °C and °F / Pressure
Moisture Content	Automatic pressure compensated conversions: ppm <sub>v</sub> for natural gas and ideal gas lb/MMscf and mg/m <sup>3</sup> for natural gas dew point at a pressure input by the user for natural gas & ideal gas Calculations for natural gas moisture content based on either ISO 18453 or IGT#8 to customer order preference
Analysis Pressure	barg, MPa and psig
<b>Sensor Technology</b>	
Sensor Technology	Michell Ceramic Metal-Oxide Moisture Sensor
Measurement Range	-120...+30 °Cdp (-184...+86 °Fdp) 1 ppb <sub>v</sub> ...30,000 ppm <sub>v</sub> 0...250 barg (0...3625 psig)
Calibration Range	-100...+20 °Cdp (-148...+68 °Fdp) 10 ppb <sub>v</sub> ...23,000 ppm <sub>v</sub>
Accuracy	Dew point: ±1 °C between -59.9 & +20 °Cdp (±1.8 °F between -75.9 and +68 °Fdp) Moisture content: ±10% of reading Dew point: ±2 °C between -60 & -100 °Cdp (±3.6 °F between -76 and -148 °Fdp) Moisture content: ±20% of reading Analysis Pressure: ±0.25% FS
Measured Resolution	0.1 °C: -80...+20 °Cdp (0.2 °F: -112...+68 °Fdp) 1 °C: -100...-80 °Cdp (2 °F: -148...-112 °Fdp)
Displayed Resolution	Dew point: 0.1 °C (0.2 °F) Moisture content: autoscale, 5 digits MPa and barg: 0.1 (1 psig)
Temperature Coefficient	Algorithm compensation
<b>HMI</b>	
Keyboard/Interface	Capacitive touch-screen through glass
Display	Vacuum fluorescent
Datalogging	A rolling maximum of 150 data logs is available Each log records time, date, moisture and pressure values for each channel 5 minutes minimum and 60 minutes maximum logging intervals can be set by the user
Communications and Output	Two non-isolated 4-20 per measurement channel 500 Ω maximum load Range and parameter settable by user Modbus RTU @ 9600 baud-rate Alarms: two volt free contacts per channel; one process value and one instrument status Also available via Modbus communications

<b>Enclosure</b>	
Main Unit Enclosure	Internal temperature control for condensation protection and stable analysis conditions
Type	Flameproof EExd
Construction	Cast copper-free aluminum
Finish	Chromate primer, Polyester P9010 powder coated (black) Meets BS3900
<b>General</b>	
Operating Pressure	30 ... 138 barg (435 ... 2000 psig)
Sample Connections	1/8" NPT(F)
Sample Flow Rate	1 NI/min (Nm <sup>3</sup> /hr) (2.1 scfh)
Sample Flow Alarm	Optional
Power Supply	90...260 V AC, 47/63 Hz, 180 W – Main Unit
Dimensions	353 x 310 x 245mm (13.8 x 12.2 x 9.6") (h x w x d) 500 x 500 x 245mm (19.7 x 19.7 x 9.6") (including installation clearance) (h x w x d)
Weight	Analyzer – 21 kg (46 lbs)
Operating Environment	Indoor/Outdoor -20...+60 °C (-4...+140 °F) Max 95 %rh Shaded location IP66/NEMA4
<b>Hazardous Area Certification</b>	
Certification Codes	See Appendix F

A.1 Mounting Drawing

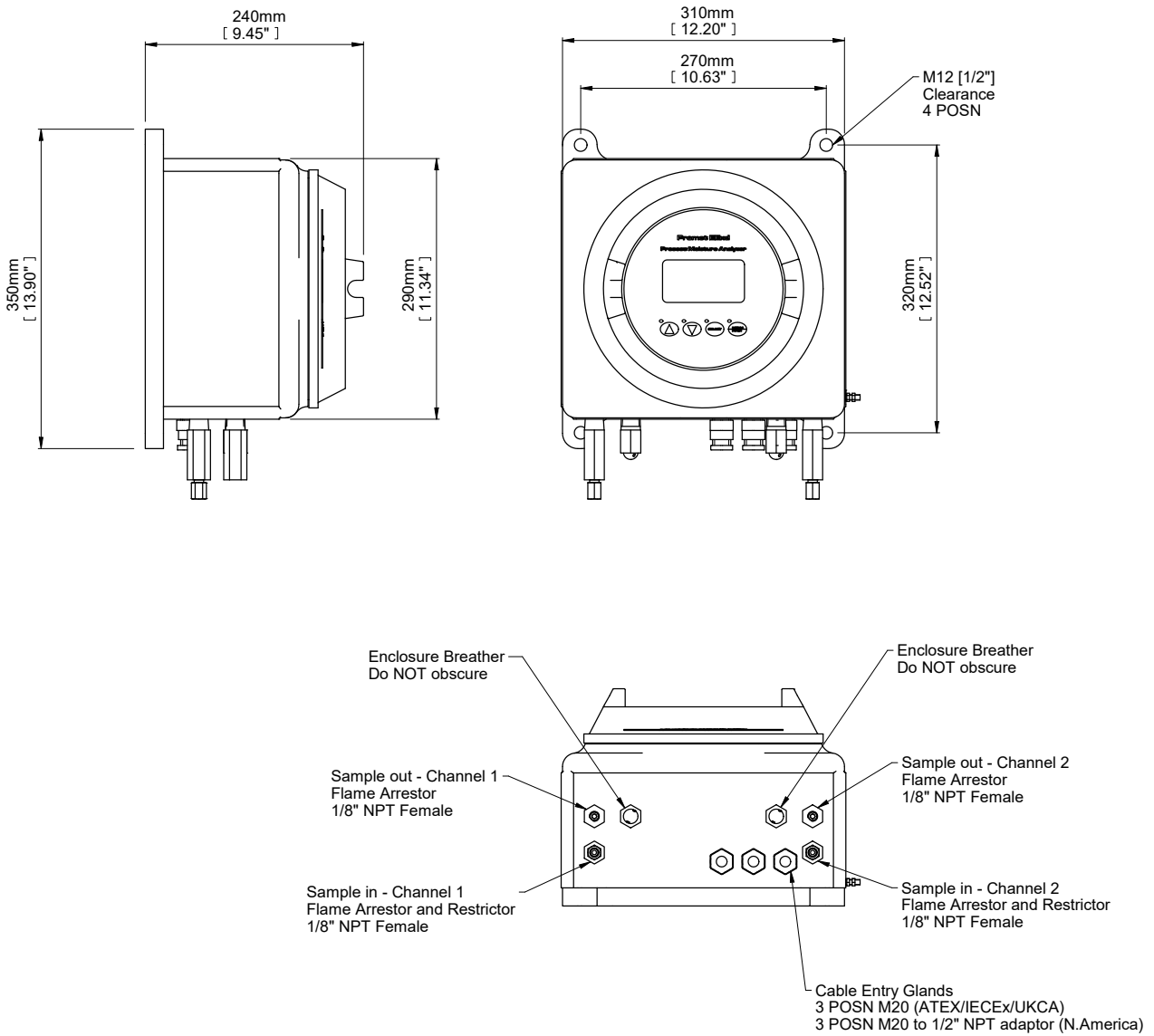

Figure 27 Mounting Drawing

A.2 Pipework Connections

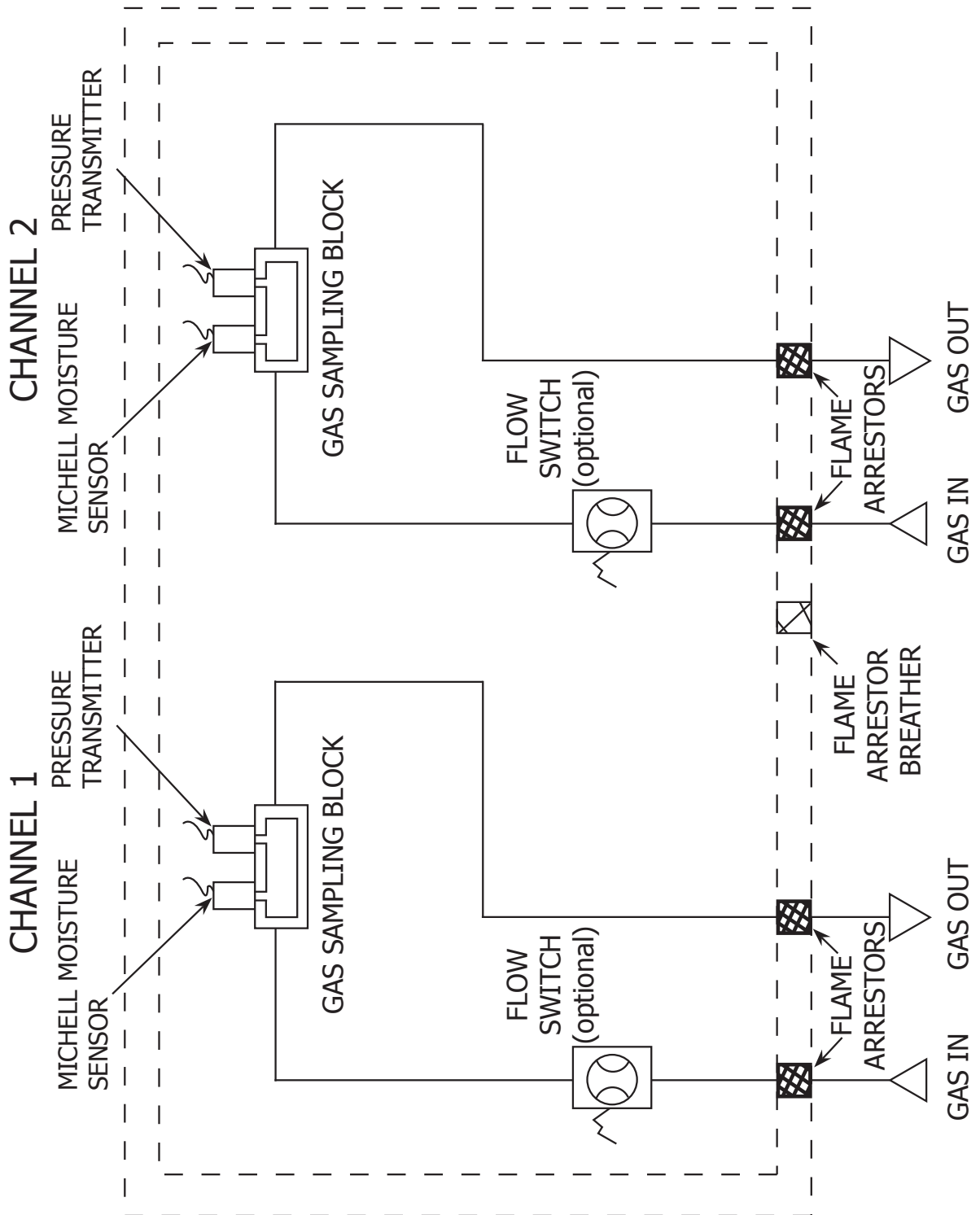

Figure 28 Pipework Connections

A.3 System Wiring Diagram

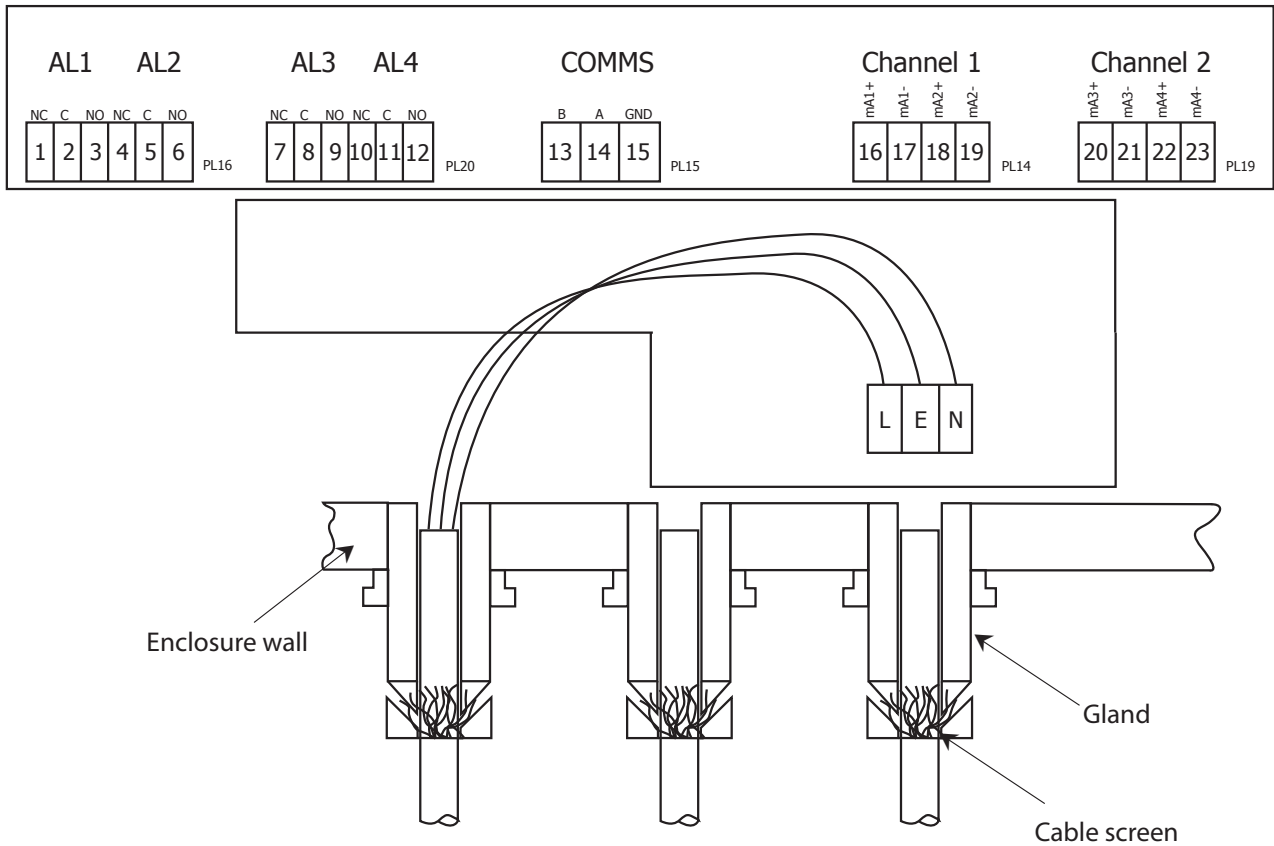

Figure 29 System Wiring Diagram



**EExd Stopping Glands MUST be used for ATEX/IECEX/UKCA installations.**

**Refer to the separate installation & maintenance information sheet supplied.**

# Appendix B

## Variable Definitions

## Appendix B Variable Definitions

From the VARIABLES page, press the **Up** (▲) or **Down** (▼) buttons to highlight the variable required. Press the **SELECT** button to enter the range/options area. Change the variable using the **Up** (▲) or **Down** (▼) buttons and press the **SELECT** button to set the new option. Scroll down to the next variable required. To return to the MAIN Page press the **MENU/MAIN** button.

Variable: **UNITS (single channel), CHN1, CHN2**

Adjustable Range/Options: **Ppm(v) IG, DP@PR idl Gas, DP@PR Nat Gas, mgm-3 Nat Gas, Ppm(v) NG, LBMMSCF, Dew point**

Description: The moisture units for Channels 1 and 2.

- i. Dew point can be displayed in either °C or °F whether it is at the sample pressure or if it is calculated to another.
- ii. When calculating the dew point at another pressure (**DP @ PR**) the **apply** option below is enabled to allow the entry of the pressure at which the dew point is to be calculated at.
- iii. mA1 and mA3 outputs represent the setting of Channel 1 and 2 respectively.

**NOTE: Changing the units clears the data logging memory and resets the analog outputs and alarm settings.**

Variable: **apply**

Adjustable Range/Options: **Pressure value in the units of pressure**

Description: The pressure value entered here is the pressure value at which dew point will be calculated at, if **DP@PR Nat Gas** or **DP@PR IDL Gas** is selected as the unit of moisture measurement. If any other unit is selected then the option will show **n/a**.

Variable: **alarm**

Adjustable Range/Options: **-100...+100 °C, 0...1200 LBMMSCF, 0.0...3000.0 Ppm(v), 0...1000mgm-3**

Description: The set point for the process alarm that activates the channel alarm relay when the moisture value exceeds it.

Variable: **OP1MIN (single channel), OP3MIN**

Adjustable Range/Options: **-100...+100 °C, 0...1200 LBMMSCF, 0.0...3000.0 Ppm(v), 0...1000mgm-3**

Description: The minimum moisture value that 4 mA represents for the respective output.

Variable: **OP2MIN (single channel), OP4MIN**

Adjustable Range/Options: **0.1...25.0 MPa/0...250 barg/0...3000 psig (for Pressure)  
-100...+100 °C/-148...+212 °F (for Dew point)**

Description: The minimum dew-point or pressure value that 4 mA represents for the respective output.

Variable: **OP1MAX (single channel), OP3MAX**

Adjustable Range/Options: **-100...+100 °C, 0...1200 LBMMSCF, 0.0...3000.0 Ppm(v),  
0...1000mgm-3**

Description: The maximum moisture value that 20 mA represents for the respective output.

Variable: **OP2MAX (single channel), OP4MAX**

Adjustable Range/Options: **0.1...25.0 MPa/0...250 barg/0...3000 psig (for Pressure)  
-100...+100 °C/-148...+212 °F (for Dew point)**

Description: The maximum dew-point or pressure value that 20 mA represents for the respective output.

Variable: **°C / °F**

Adjustable Range/Options: **Celsius or Fahrenheit**

Description: Dew-point unit of measurement, in °C or °F.

**NOTE:** Changing the temperature units will set the default values and clear the logged data.

Variable: **Pressure**

Adjustable Range/Options: **MPa, barg, psig**

Description: Units of measurement for the pressure values. psig, barg or MPa may be selected.

**NOTE:** Changing the pressure units will clear the logged data.

Variable: **TIME**

Adjustable Range/Options: **hh:mm; 00:00...23:59**

Description: The real-time clock in 24hr format. Minutes and hours may be adjusted. Pressing either the **Up (▲)** or **Down (▼)** buttons will increment or decrement the minute's field and the corresponding hours field will change automatically.

Variable: **DATE**

Adjustable Range/Options: **Day: 01-31, Month: 01-12, Year: 00-99**

Description: The date. Format: ddmmyy. To adjust the day, highlight the **DATE** field, press **SELECT** (a 'd' should appear to the right of the year value). Use the **Up (▲)** or **Down (▼)** buttons to adjust. To adjust the month and year, press **SELECT** again (an 'm' should appear to the right of the year value). Use the **Up (▲)** or **Down (▼)** buttons to adjust the month. As the month changes, the year field will change automatically. Press **SELECT** to finish.

Variable: **OP2/4 PARAM**

Adjustable Range/Options: **Measured Dew point, Pressure**

Description: The parameter selected for mA2 (and mA4) outputs.

Variable: **LOG INT'VAL**

Adjustable Range/Options: **10...60 in intervals of 10 minutes**

Description: Sets the interval between the logged data readings.

Variable: **RESET LOG**

Adjustable Range/Options: **select, done**

Description: Resets the logging statistics so that the variation in measurements can be recorded from a user-defined start point. When the **RESET LOG** variable is highlighted press the **SELECT** button – the option will go from **select** to **done**.

Variable: **INST ADDR**  
 Adjustable Range/Options: **01...31**

Description: Unique instrument address for networking. This address is used by the Modbus protocol to specify the location of the Promet EExd instrument in the network.

Variable: **INT TEMP SP**  
 Adjustable Range/Options: **-20...+60 °C**

Description: Sets the set point for the internal heater.

Variable: **SET DEFAULT**  
 Adjustable Range/Options: **select, done**

Description: Sets instrument to default configuration. The default values for all the variables and parameters are set.

The default values are:

Units/CHN1/2	Dew point
<b>apply</b>	N/A
<b>alarm</b>	0 °C
<b>OP1 Min</b>	-100 °C
<b>OP1 Max</b>	+20 °C
<b>OP2 Min</b>	0 barg
<b>OP2 Max</b>	250 barg
<b>OP3 Min</b>	-100 °C
<b>OP3 Max</b>	+20 °C
<b>OP4 Min</b>	0 barg
<b>OP4 Max</b>	250 barg
<b>°C/°F</b>	Celcius
<b>Pressure</b>	barg
<b>LOG INT</b>	10mins
<b>INST ADD</b>	01
<b>INT TEMP SP</b>	+20 °C

# Appendix C

## Modbus RTU Communications

## Appendix C Modbus RTU Communications

### C.1 Introduction

Implemented within the Promet EExd are Modbus RTU communications that enable remote access to the instrument's configuration and data logging facilities. This protocol offers two-way communication between a PC or PLC known as the master, to one or more instruments known as slaves. Communication is achieved by the master reading or writing to registers within the slave. The slave acts upon information contained within the registers that can be written, and the master obtains measured values and status information from the register that can be read. Appendix D lists these registers and Appendix E specifies the number or data formats that apply to each register.

### C.2 Modbus RTU Basics

Modbus RTU operates on a Query-Response Cycle (see the diagram below). The function code in the query tells the addressed slave device which actions to perform using the information contained in the data bytes. The error check field provides a method for the slave to validate the integrity of the message contents.

If the slave makes a normal response, the function code in the response is an echo of the function code in the query and the data bytes will contain data collected by the slave, such as register values or status information. If an error occurs, the function code is incremented by 80H. This indicates that the response is an error response, known as an exception, and the data bytes contain a code to describe the error. The error check field allows the master to confirm that the message contents are valid.

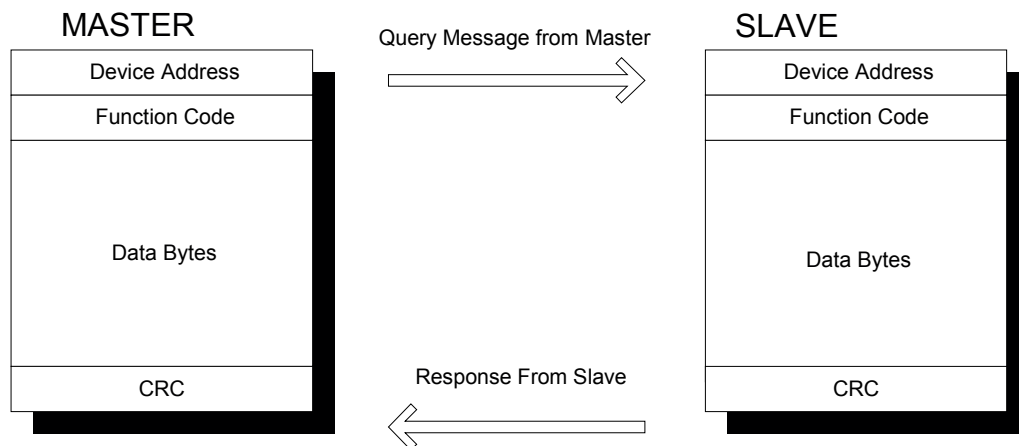

### C.3 Physical Layer

The physical connection from the master to the Promet EExd uses 2-wire RS485 plus a ground connection. Data lines A, B and ground are connected to communication connectors within the instrument. The serial port protocol is as follows:

Baud Rate: 9600  
 Start Bit: 1  
 Data bits: 8  
 Parity: None  
 Stop bit: 2

## C.4 Termination Resistor

A 120  $\Omega$  termination resistor is provided on the instrument's circuit board for systems that require it. To connect the resistor, place the link provided across JMP2.

## C.5 Register Map

The following tables describe the instrument registers with their address location, Modbus function and the number format.

### System Parameters

Address dec	Address hex	Function	Read/Write	Default Value	Register Configuration
0	0000*	Instrument Address	R/W	0001H	F
1	0001	Sensor 1 Moisture Value – Hi Word	R		L
2	0002	Sensor 1 Moisture Value – Lo Word	R		L
3	0003	Sensor 1 Ambient Temperature	R		H
4	0004	Status	R		D
5	0005	Sensor 2 Moisture Value – Hi Word	R		L
6	0006	Sensor 2 Moisture Value – Lo Word	R		L
7	0007	Time to next log Mins + Secs	R		I
8	0008	Sensor 2 Ambient Temperature	R		H
9	0009	Sensor 1 Pressure value	R		H
10	000A	Sensor 2 Pressure value	R		H
11	000B	Sensor 1 Moisture Setting	R/W	0001H	B
12	000C*	mA1 output maximum value (sensor 1 moisture)	R/W	0032H	K
13	000D*	mA1 output minimum value (sensor 1 moisture)	R/W	FFCEH	K
14	000E*	mA2 output maximum value (sensor 1 pressure)	R/W	0BB8H	M
15	000F*	mA2 output minimum value (sensor 1 pressure)	R/W	0000H	M
16	0010*	Sensor 2 Moisture Setting	R/W	0001H	B
17	0011*	mA3 output maximum value (sensor 2 moisture)	R/W	0032H	F
18	0012*	mA3 output minimum value (sensor 2 moisture)	R/W	FFCEH	K
19	0013*	Logging Interval	R/W	000AH	I
20	0014*	mA4 output maximum value (sensor 2 pressure)	R/W	0BB8H	M
21	0015*	mA4 output minimum value (sensor 2 pressure)	R/W	0000H	M
22	0016*	Sensor 1 Alarm Set Point	R/W	0000H	K
23	0017*	Sensor 2 Alarm Set Point	R/W	0000H	K
24	0018*	RTC Year (val1) + Month (val2)	R/W		I
25	0019*	RTC Date (val1) + Hours (val2)	R/W		I
26	001A*	RTC Mins (val1) + Secs (val2)	R/W		I
27	001B*	Sensor 1 Pressure Set (DP @ Pressure)	R/W		H
28	001C*	Sensor 2 Pressure Set (DP @ Pressure)	R/W		H
29	001D	Units/ Command	R/W	000000H	E
30	001E	Moisture Sensor 1 – Batch Number	R		I
31	001F	Moisture Sensor 1 – Serial Number	R		I
32	0020	Moisture Sensor 1 – Year	R		I
33	0021	Moisture Sensor 1 – Month and day	R		I
34	0022	Moisture Sensor 1– Hours Of Operation	R		F

Address dec	Address hex	Function	Read/Write	Default Value	Register Configuration
35	0023	Error Indicator	R		C
36	0024	Not Used			
37	0025	Internal Temperature	R		A
38	0026	Internal Temp Set Point	R/W	07D0H	A
39	0027	Moisture Sensor 2 – Batch Number	R		I
40	0028	Moisture Sensor 2 – Serial Number	R		I
41	0029	Moisture Sensor 2 – Year	R		I
42	002A	Moisture Sensor 2 – Month and day	R		I
43	002B	Moisture Sensor 2 – Hours Of Operation	R		F
44	002C	Not Used			
45	002D	Moisture max – Hi Word – Sensor 1	R		L
46	002E	Moisture max – Lo Word – Sensor 1	R		L
47	002F	Occurred @ day (val1) + month (val2)	R		J
48	0030	Occurred @ hour (val1) + min (val2)	R		J
49	0031	Moisture min – Hi Word – Sensor 1	R		L
50	0032	Moisture min – Lo Word – Sensor 1	R		L
51	0033	Occurred @ day (val1) + month (val2)	R		J
52	0034	Occurred @ hour (val1) + min (val2)	R		J
53	0035	Moisture average Hi Word – Sensor 1	R		L
54	0036	Moisture average Lo Word – Sensor 1	R		L
55	0037	Sensor 1 Measured dew point – Hi Word	R		L
56	0038	Sensor 1 Measured dew point – Lo Word	R		L
57	0039	Instrument Type	R	0002H	I
58	003A	Firmware Version Number	R		I
59	003B	Sensor 2 Measured dew point – Hi Word	R		L
60	003C	Sensor 2 Measured dew point – Lo Word	R		L
61	003D	Moisture max – Hi Word – Sensor 2	R		L
62	003E	Moisture max – Lo Word – Sensor 2	R		L
63	003F	Occurred @ day (val1) + month (val2)	R		J
64	0040	Occurred @ hour (val1) + min (val2)	R		J
65	0041	Moisture min – Hi Word – Sensor 2	R		L
66	0042	Moisture min – Lo Word – Sensor 2	R		L
67	0043	Occurred @ day (val1) + month (val2)	R		J
68	0044	Occurred @ hour (val1) + min (val2)	R		J
69	0045	Moisture average Hi Word – Sensor 2	R		L
70	0046	Moisture average Lo Word – Sensor 2	R		L
71	0047	Not Used			
72	0048	Not Used			
73	0049	Pressure max – Sensor 1	R		H
74	004A	Occurred @ day (val1) + month (val2)	R		J
75	004B	Occurred @ hour (val1) + min (val2)	R		J
76	004C	Pressure min – Sensor 1	R		H
77	004D	Occurred @ day (val1) + month (val2)	R		J
78	004E	Occurred @ hour (val1) + min (val2)	R		J
79	004F	Pressure average – Sensor 1	R		H
80	0050	Pressure max – Sensor 2	R		H

Address dec	Address hex	Function	Read/Write	Default Value	Register Configuration
81	0051	Occurred @ day (val1) + month (val2)	R		J
82	0052	Occurred @ hour (val1) + min (val2)	R		J
83	0052	Pressure min – Sensor 2	R		H
84	0053	Occurred @ day (val1) + month (val2)	R		J
85	0054	Occurred @ hour (val1) + min (val2)	R		J
86	0055	Pressure average – Sensor 2	R		H
87	0056	Not Used			
88	0057	Not Used			



# Appendix D

## Modbus RTU Details

## Appendix D Modbus RTU Details

### D.1 Message Framing

START	ADDRESS	FUNCTION CODE	DATA	CRC	END
3.5t	1 byte	1 byte	n x bytes	2 bytes	3.5t

#### Start and End

The message begins and ends with a silent delay of 3.5 character times at the baud rate of the network.

#### Address

The first byte transmitted is the address of the instrument, which has a range of 1...247 or 01H...F7H. The master addresses an instrument by placing the address in the address byte and, if matched, a Promet EExd will respond to the message, otherwise it will be ignored. See Appendix B on setting the address.

#### Function Code

The function code tells the Promet EExd which operation is to be performed on the data in the following data bytes. The only valid codes are **03 (Read Holding Registers)** or **06 (Write To Single Register)** as these are the only two implemented.

An exception can occur if the message contains an unsupported function code, an illegal data address or an illegal data value. If this occurs, the function code is incremented by 80H and the data bytes returned are set to a value that describes the error. See Appendix D.3: Exceptions.

#### Data Bytes

The data bytes within the message from the master contain additional information that the Promet EExd must use to perform the action defined in the function code, such as the starting register address and the number of registers to be retrieved.

#### CRC

The CRC is a 2-byte error check value from the result of a Cyclical Redundancy Check calculation performed on the message contents. The CRC is appended to the message as the last field in the message, whereby the low-order byte is appended first, followed by the high-order byte.

D.2 Implemented Functions

03 Read Holding Registers

This function code is used to read the contents of a contiguous block of holding registers, where the master specifies the starting address and the number of registers to be read. Figure 32 shows the state diagram of how the message is processed with the exceptions that may be raised.

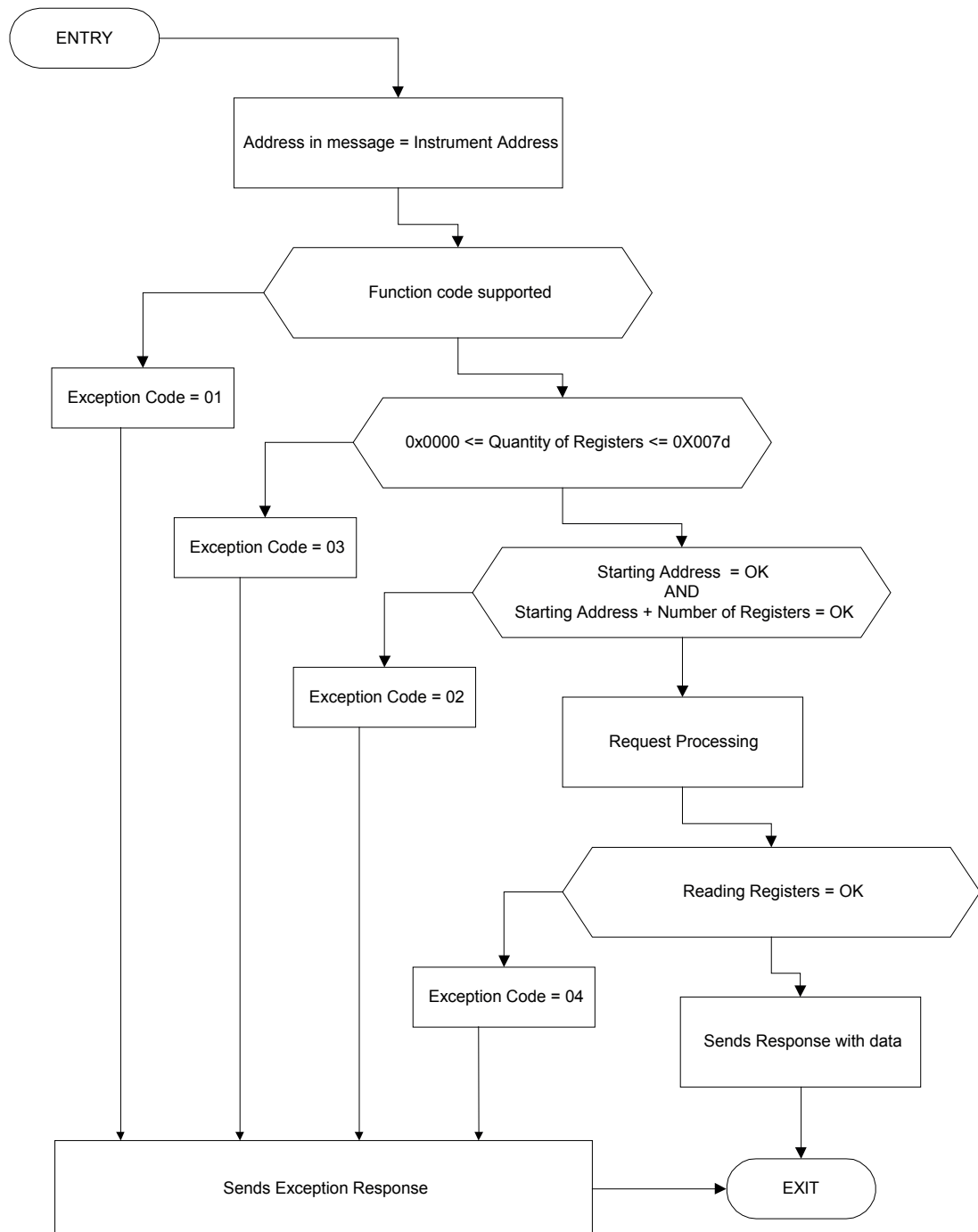

Figure 30 Reading Holding Registers State Diagram

The table below is an example of a message sent by the master, to read the time to the next log (register 7) and Channel 2 gas temperature (register 8). The message shows a master addressing a Promet EExd with a slave address of 01H and a Modbus function of 03H that informs the Promet EExd that it wishes to read two registers starting from address 07H. Bytes 3 & 4 hold the starting address and bytes 5 & 6 hold the number of registers to be read. Bytes 7 & 8 contain the CRC code that is calculated using bytes 1 to 6 as represented below.

Byte No	Meaning	Value
1	Slave Address	01H
2	MODBUS function code	03H
3	Starting Address MSB	00H
4	Starting Address LSB	07H
5	No of points MSB	00H
6	No of points LSB	02H
7	CRC Lo Byte	??H
8	CRC Hi Byte	??H

### Read Request Message

In response to the above message, the Promet EExd may transmit the following message.

Byte No	Meaning	Value
1	Slave Address	01H
2	MODBUS function code	03H
3	Byte Count	04H
4	Data MSB	05H
5	Data LSB	26H
6	Data MSB	00H
7	Data LSB	FAH
8	CRC Lo Byte	??H
9	CRC Hi Byte	??H

### Read Response Message

This response repeats the address of the Promet EExd and the function code, along with the byte count, the data and the CRC. In this example, the request asked for the values from two registers. Therefore, the number of bytes returned is four. The value of register 7 is contained in bytes 4 & 5 and the value of register 8 in bytes 6 & 7. Register 7 = 5m 26s and register 7 = 00FA = 252 = 25.2 °C in this example. Any errors within the data of Read Request Message will result in an exception being raised.

06 Write to Single Register

This function code is used to write a 16 bit value into a single register, whereby the master specifies the address and the value to be written. Figure 33 shows the state diagram of how the message is processed with the exceptions that may be raised.

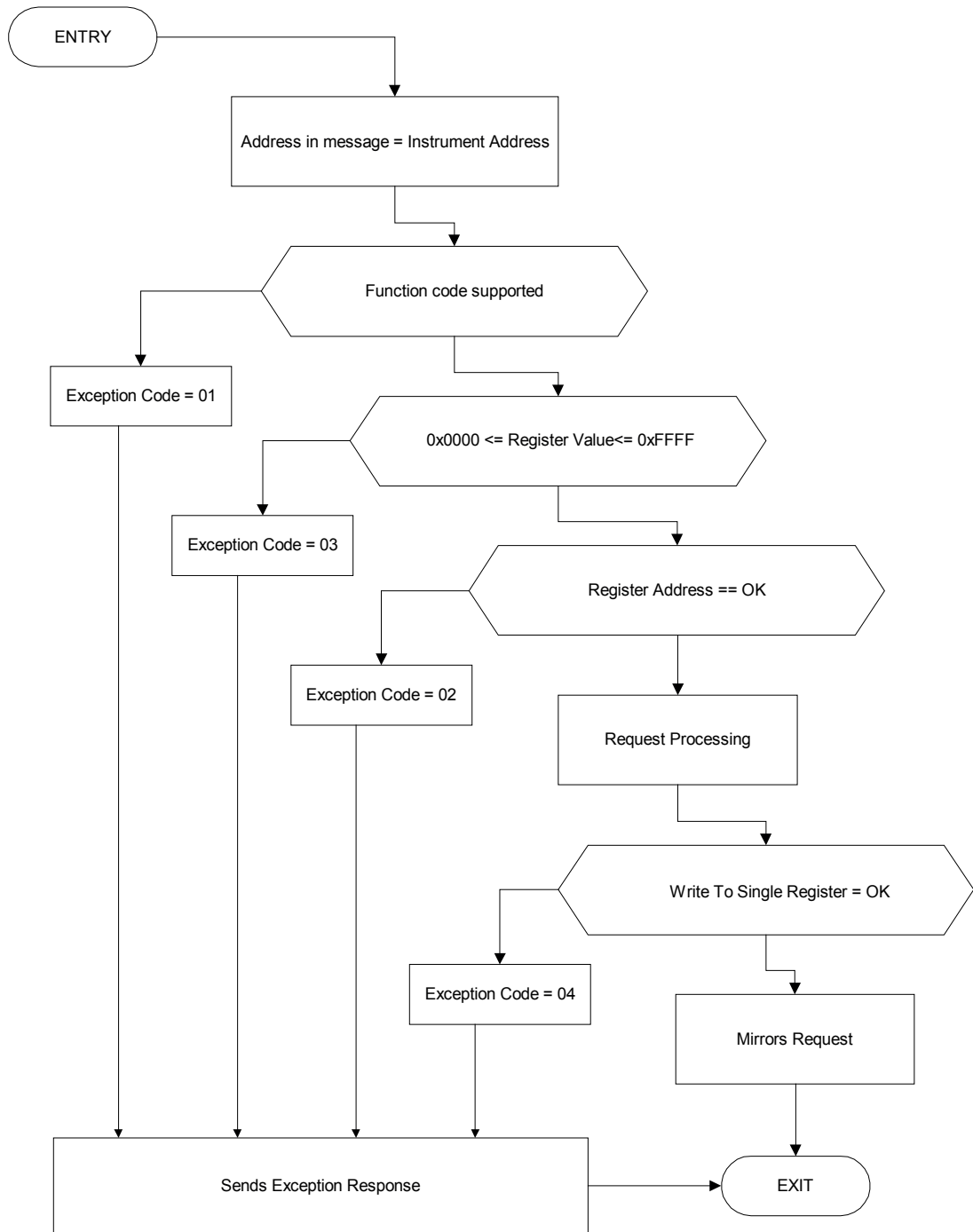

Figure 31 Write Single Register State Diagram

The table below shows the data bytes in a **Write To Single Register** message. Bytes 1 to 4 contain the address of the Promet EExd, Modbus function, starting register address and the data value to be written. In this example a master sends FC18H to address 0015H, to a Promet EExd with an address of 01H. The CRC is calculated using the data in bytes 1 to 6.

Byte No	Meaning	Value
1	Slave Address	01H
2	MODBUS function code	06H
3	Starting Address MSB	00H
4	Starting Address LSB	15H
5	Data MSB	FCH
6	Data LSB	18H
7	CRC Lo Byte	??H
8	CRC Hi Byte	??H

### Write Single Register Request and Response

The normal response from the Promet EExd is to re-transmit the received message. However, if the data within the message is incorrect then an exception response will be transmitted.

### D.3 Exceptions

A message request from the master will raise an exception response from the slave (Promet EExd) if:

- i. the function code is unsupported
- ii. the register quantity > 127 (0x007D)
- iii. the register address is invalid
- iv. the register address + the quantity of register is invalid
- v. an error occurred while performing the function

The exception response will contain the function code incremented by 80H and the exception code.

The table below lists the codes supported, along with an explanation of each code.

Code	Name	Meaning
01	ILLEGAL FUNCTION	The function code received in the query is not an allowable action for the slave
02	ILLEGAL DATA ADDRESS	The data address received in the query is not allowable. More specifically, the combination of starting address and number of registers is invalid for the slave
03	ILLEGAL DATA VALUE	A value contained in the query data field is not an allowable value for the slave
04	SLAVE DEVICE FAILURE	An unrecoverable error occurred while the slave was attempting to perform the requested action

Example of an Exception Response that reads a discrete inputs message generating an illegal function exception.

Byte	Meaning	Value
1	Slave Address	01H
2	Function	82H
3	Exception Code	01H
4	CRC	??

The example above shows the function code (02H) sent in the request has been incremented by 80H with the exception code 01H included as the data within the message.

# Appendix E

## Register Number Formats

Appendix E Register Number Formats

Register Configuration A

15	14	13	12	11	10	9	8	7	6	5	4	3	2	1	0
r	r	r	r	r	r	r	r	r	r	r	r	r	r	r	r

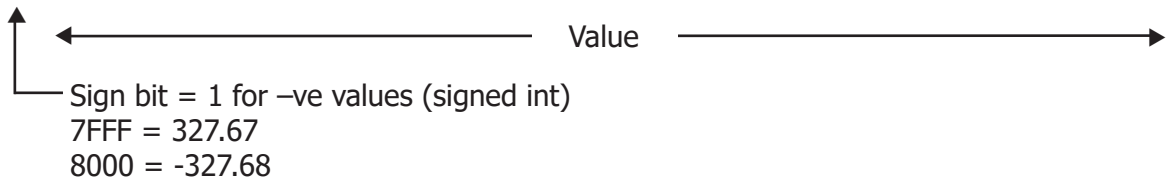

The value in bits (15...0) + 1 is divided by 100 to give 0.01 resolution for dew-point and temperature values.

Register Configuration B – Sensor Moisture Value

15	14	13	12	11	10	9	8	7	6	5	4	3	2	1	0
r/w	r/w	r/w	r/w	r/w	r/w	r/w	r/w	r/w	r/w	r/w	r/w	r/w	r/w	r/w	r/w
N/A	N/A	N/A	N/A	N/A	N/A	N/A	N/A	N/A	Ppm(v) for Ideal Gas	Dp @ Pressure for Ideal Gas	Dp @ Pressure for Natural Gas	m/gm <sup>3</sup> for Natural Gas	Ppm(v) for Natural Gas	lb/MMscf	Dp

The bit settings are mutually exclusive.

Register Configuration C – Error Conditions

15	14	13	12	11	10	9	8	7	6	5	4	3	2	1	0
r	r	r	r	r	r	r	r	r	r	r	r	r	r	r	r

Bit	HEX	Error Condition
0	0001	Sensor 1 under range
1	0002	Sensor 1 over range
2	0004	Sensor 1 temperature fault
3	0008	Sensor 1 No flow
4	0010	Sensor 1 pressure transmitter failure
5	0020	Sensor 1 LBMMSCF calculation error
6	0040	NOT USED
7	0080	Sensor 2 under range
8	0100	Sensor 2 over range
9	0200	Sensor 2 temperature fault
10	0400	Sensor 2 No flow
11	0800	Sensor 2 pressure transmitter failure
12	1000	Sensor 2 LBMMSCF calculation error
13	2000	NOT USED
14	4000	Internal heater fault

Register Configuration D – Status Word

15	14	13	12	11	10	9	8	7	6	5	4	3	2	1	0
N/A	N/A	N/A	N/A	N/A	N/A	Process Alarm 2	Process Alarm 1	Flow Channel 2	Flow Channel 1	N/A	Sensor 1 Fitted	Sensor 2 Fitted	N/A	N/A	N/A

1 = ON or Fitted  
 0 = OFF or Not Fitted

Register Configuration E – Units Command

15	14	13	12	11	10	9	8	7	6	5	4	3	2	1	0
N/A	N/A	N/A	N/A	N/A	N/A	N/A	N/A	N/A	w	w	w	r/w	r/w	r/w	r/w
									Reset Defaults	Reset Logging	N/A	IGT/ ISO 0 = IGT	MPa	Psig/barg 0 = psig	°C/°F 0 = °C

1 = ON / Fitted / Initiate  
 0 = OFF or Not Fitted

Register Configuration F

15	14	13	12	11	10	9	8	7	6	5	4	3	2	1	0
r/w	r/w	r/w	r/w	r/w	r/w	r/w	r/w	r/w	r/w	r/w	r/w	r/w	r/w	r/w	r/w

Unsigned integer. Range = 0...65535

Register Configuration H

15	14	13	12	11	10	9	8	7	6	5	4	3	2	1	0
r	r	r	r	r	r	r	r	r	r	r	r	r	r	r	r

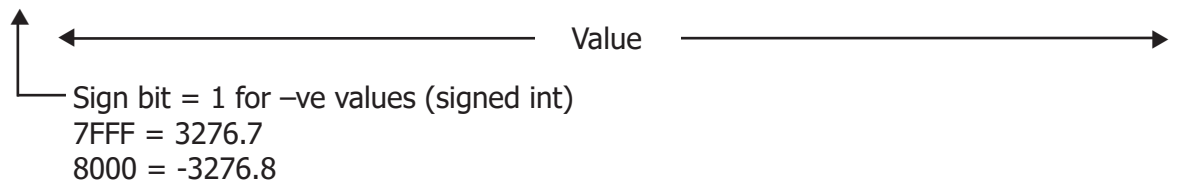

The value in bits (15...0) + 1 is divided by 10 to give 0.1 resolution for dew-point and temperature values.

**Register Configuration I**

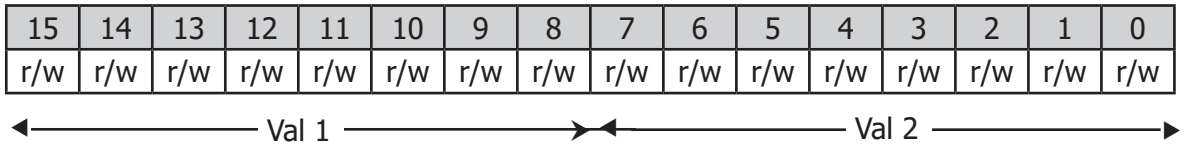

Val 1 & 2 are in BCD, therefore 10H = 10, 58H = 58 and 09H = 9 etc. As a result A to F are not valid values.

Values for Cycle Time and Max Cool Time are in units of 5 mins.

**Register Configuration J**

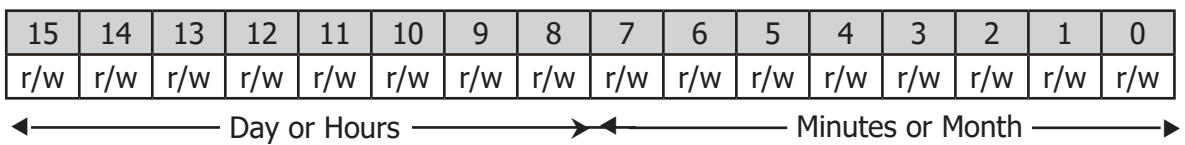

Values in HEX i.e. 17th March = 1103H

**Register Configuration K – signed int**

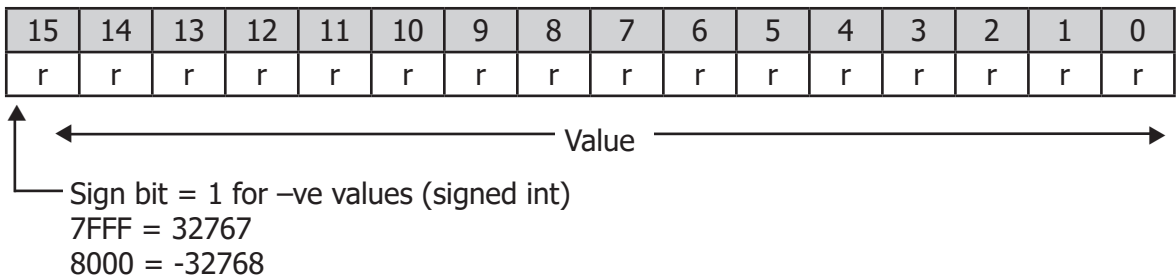

**Register Configuration L – Floating Point Representation**

The humidity values for sensors 1 & 2 are represented in IEEE-754 single precision floating point format, in order to cater for the wide range in the value of ppm<sub>v</sub>. This format is 'Big Ended' which means that the High byte is at a lower address in memory than the Lo byte, and is represented as such in the register memory map. The IEEE-754 format is shown below.

<p><b>Bit 31</b> Sign bit 0 = + 1 = -</p>	<p><b>Bits 30 to 23</b> Exponent Field Has a +127 bias value</p>	<p><b>Bits 22 to 0</b> mantissa Decimal representation of binary Where 1.0 ≤ value &lt; 2.0</p>
---	--	---

Examples of floating point to HEX are shown below.

**1) +10.3**

sign bit = 0

Exponent = 3, therefore exponent field =  $127 + 3 = 130$ , and bits 30 to 23 = 10000010

Mantissa = 1.2875 which in binary representation = 1 .01001001 1001 1001 1001 101

Adjusting the mantissa for the exponent moves the decimal point to the right if positive and to the left if negative.

As the exponent is = 3 then the mantissa becomes = 1010.0100 1100 1100 1100 1 101, therefore:-

$$1010 = (1 \times 2^3) + (0 \times 2^2) + (1 \times 2^1) + (0 \times 2^0) = 10 \text{ and}$$

$$0100 1100 1100 1100 1101 = (0 \times 2^{-1}) + (1 \times 2^{-2}) + \dots + (1 \times 2^{-20}) = 0.3$$

$$\begin{aligned} \text{Therefore the word value} &= 0100 0001 0010 0100 1100 1100 1100 1101 \\ &= 4124\text{CCCD} \end{aligned}$$

Consequently, for sensor 1 register 0001 = 4124 and register 0002 = CCCD

**2) - 0.0000045**

sign bit = 1

Exponent = -18, therefore exponent field =  $127 + (-18) = 109$ , and bits 30 to 23 = 01101101

Mantissa = 1.179648 which in binary representation = 1 .00101101111111010110101

$$\text{i.e. } (1 \times 2^{-18}) + (1 \times 2^{-21}) + (1 \times 2^{-23}) \text{ etc} = 0.0000045$$

$$\begin{aligned} \text{Therefore the word value} &= 1011 0110 1001 0110 1111 1110 1011 0101 \\ &= \text{B696FEB5} \end{aligned}$$

Consequently, for sensor 1 register 0001 = B696 and register 0002 = FEB5

**Register Configuration M**

15	14	13	12	11	10	9	8	7	6	5	4	3	2	1	0
r/w	r/w	r/w	r/w	r/w	r/w	r/w	r/w	r/w	r/w	r/w	r/w	r/w	r/w	r/w	r/w

Unsigned integer / 10  
Range = 0...6553.5

# Appendix F

## Hazardous Area Certification

## Appendix F Hazardous Area Certification

The Promet EExd is certified compliant to the ATEX Directive (2014/34/EU), the IECEx scheme and SI 2016 No. 1107 UKCA product marking scheme for use within Zone 1 & 2 Hazardous Areas and has been assessed as being so by ELEMENT MATERIALS TECHNOLOGY Ltd (Notified Body 2812) and ELEMENT MATERIALS TECHNOLOGY Ltd (Approved Body 0891).

The Promet EExd is certified compliant to the applicable North American Standards (USA and Canada) for use within Class I, Division 1 and Class I, ZONE 1 Hazardous Locations and has been assessed as being so by QPS Evaluation Services Inc.

### F.1 Product Standards

This product conforms to the Standards:

BS/EN60079-0:2018	IEC60079-0:2017
BS/EN60079-1:2014	IEC60079-1:2014
CSA C22.2 No. 30-20	ANSI/UL 60079-0 7th ed.
CSA C22.2 No. 60079-0-19	ANSI/UL 60079-1-7th ed.
CSA C22.2 No. 60079-1-16	UL/ANSI 61010-1, 3rd ed.
CSA C22.2 No. 61010-1-12	UL1203 5th ed.

### F.2 Product Certification

#### Using Michell BR BREATHER

ATEX & UKCA  
II 2 G  
Ex db IIB + H2 Gb  
T5 (Tamb -40 °C...+44 °C)  
T4 (Tamb -40 °C...+60 °C)

IECEX  
Ex db IIB + H2 Gb  
T5 (Tamb -40 °C...+44 °C)  
T4 (Tamb -40 °C...+60 °C)

cQPSus  
Class I, Division 1,  
Groups B, C & D  
T5 (Tamb -25 °C...+44 °C)  
T4 (Tamb -25 °C...+60 °C)

CL I ZONE 1  
Ex db IIB+H2 Gb  
AEx db IIB+H2 Gb  
T5 (Tamb -40 °C...+44 °C)  
T4 (Tamb -40 °C...+60 °C)

#### Using Killark KQBA 1/2" NPT BREATHER

ATEX & UKCA  
II 2 G  
Ex db IIB + H2 T3 Gb  
Tamb -40 °C...+60 °C

IECEX  
Ex db IIB + H2 T3 Gb  
Tamb -40 °C...+60 °C

cQPSus  
Class I, Division 1,  
Groups B, C & D  
T3 Tamb -40 °C...+60 °C

CL I ZONE 1  
Ex db IIB+H2 T3 Gb  
AEx db IIB+H2 T3 Gb  
Tamb -40 °C...+60 °C

#### Using Killark KQBA M20 BREATHER

ATEX & UKCA  
II 2 G  
Ex db IIB T4 Gb  
Tamb -40 °C...+60 °C

IECEX  
Ex db IIB T4 Gb  
Tamb -40 °C...+60 °C

cQPSus  
Class I, Division 1,  
Groups B, C & D  
T4 Tamb -40 °C...+60 °C

CL I ZONE 1  
Ex db IIB T4 Gb  
AEx db IIB T4 Gb  
Tamb -40 °C...+60 °C

### F.3 Global Certificates/Approvals

ATEX	TRAC11ATEX21319X
IECEX	IECEX TRC 11.0008X
UKCA	EMA21UKEX0002X
cQPSus	LR1507-7

These certificates can be viewed or downloaded from our websites at:  
[www.processsensing.com](http://www.processsensing.com) & [www.michell.com](http://www.michell.com)



**Special attention should be paid to the *Special Conditions for Safe Use* and the *Conditions of Certification* listed in the certificates shown on the website.**

### F.4 Special Conditions of Use

1. Do not open when an explosive gas atmosphere may be present.
2. External cables shall be compatible with a temperature of 93°C (T5) or 109 °C (T4/T3).
3. Maximum process pressure shall not exceed 138 bar when the Killark breather is fitted or 60 bar when the Michell/M.A.M breather is fitted.
4. Maximum combined process flow into the enclosure shall not exceed 1.5 LPM.
5. All process lines shall be purged to ensure the process gas or liquid is above its upper explosive limit before applying power.
6. Where painted or powder coated, the enclosures could present an electrostatic hazard. Clean only with a damp or anti-static cloth.
7. The enclosure is to be earthed externally using the earth point provided.
8. Only suitably ATEX/IECEX/UKCA/NRTL certified (as appropriate) cable glands and blanking elements shall be used.

Refer to the relevant sections within this manual for the connection, wiring and cable glanding requirements.

### F.5 Maintenance and Installation

The Promet EExd must only be installed by suitably qualified personnel and in accordance with the instructions provided and the terms of the applicable product certificates.

Maintenance and servicing of the product must only be carried out by suitably trained personnel or returned to an approved Michell Instruments Service Center.

Flame paths are not intended to be repaired.

# Appendix G

## Pressure Equipment Directive Compliance Statement

**Appendix G      Pressure Equipment Directive Compliance Statement**

The Pressure Equipment Directive 97/23/EC has been implemented in United Kingdom Law by the Pressure Equipment Regulations 1999.

The regulations require that all pressure equipment and assemblies within scope must be safe when placed on the market or put into service.

Our equipment has been assessed and is classified according to the classification charts detailed in Annex II of these regulations as falling into the Sound Engineering Practice (SEP) Conformity Assessment Category.

Michell Instruments Ltd warrants that its equipment has been designed and manufactured according to SEP.

# Appendix H

## Quality, Recycling & Warranty Information

---

## Appendix H    Quality, Recycling & Warranty Information

Michell Instruments is dedicated to complying to all relevant legislation and directives. Full information can be found on our website at:

**[www.michell.com/compliance](http://www.michell.com/compliance)**

This page contains information on the following directives:

- Anti-Facilitation of Tax Evasion Policy
- ATEX Directive
- Calibration Facilities
- Conflict Minerals
- FCC Statement
- Manufacturing Quality
- Modern Slavery Statement
- Pressure Equipment Directive
- REACH
- RoHS3
- WEEE2
- Recycling Policy
- Warranty and Returns

This information is also available in PDF format.

# Appendix I

## Return Document & Decontamination Declaration

Appendix I Return Document & Decontamination Declaration

**Decontamination Certificate**

**IMPORTANT NOTE:** Please complete this form prior to this instrument, or any components, leaving your site and being returned to us, or, where applicable, prior to any work being carried out by a Michell engineer at your site.

Instrument			Serial Number	
Warranty Repair?	YES	NO	Original PO #	
Company Name			Contact Name	
Address				
Telephone #			E-mail address	
Reason for Return /Description of Fault:				
Has this equipment been exposed (internally or externally) to any of the following? Please circle (YES/NO) as applicable and provide details below				
Biohazards			YES	NO
Biological agents			YES	NO
Hazardous chemicals			YES	NO
Radioactive substances			YES	NO
Other hazards			YES	NO
Please provide details of any hazardous materials used with this equipment as indicated above (use continuation sheet if necessary)				
Your method of cleaning/decontamination				
Has the equipment been cleaned and decontaminated?			YES	NOT NECESSARY
Michell Instruments will not accept instruments that have been exposed to toxins, radio-activity or bio-hazardous materials. For most applications involving solvents, acidic, basic, flammable or toxic gases a simple purge with dry gas (dew point <-30°C) over 24 hours should be sufficient to decontaminate the unit prior to return. <b>Work will not be carried out on any unit that does not have a completed decontamination declaration.</b>				
<b>Decontamination Declaration</b>				
I declare that the information above is true and complete to the best of my knowledge, and it is safe for Michell personnel to service or repair the returned instrument.				
Name (Print)			Position	
Signature			Date	





Instrument Expert  
Original factory  
packaging  
[www.keruiyiqi.cn](http://www.keruiyiqi.cn)

[www.ProcessSensing.com](http://www.ProcessSensing.com)



<http://www.michell.com>