



# Condumax II Hydrocarbon Dew-Point Analyzer User Manual



Please fill out the form(s) below for each instrument that has been purchased.

Use this information when contacting Michell Instruments for service purposes.

Product Name	
Order Code	
Serial Number	
Invoice Date	
Installation Location	
Tag Number	

Product Name	
Order Code	
Serial Number	
Invoice Date	
Installation Location	
Tag Number	

Product Name	
Order Code	
Serial Number	
Invoice Date	
Installation Location	
Tag Number	



## Condumax II

For Michell Instruments' contact information please go to  
[www.michell.com](http://www.michell.com)

© 2021 Michell Instruments

This document is the property of Michell Instruments Ltd and may not be copied or otherwise reproduced, communicated in any way to third parties, nor stored in any Data Processing System without the express written authorization of Michell Instruments Ltd.

---

**Contents**

Safety .....vii  
 Electrical Safety .....vii  
 Pressure Safety .....vii  
 Toxic Materials.....vii  
 Repair and Maintenance.....vii  
 Calibration (factory validation) .....vii  
 Safety Conformity .....vii  
 Abbreviations.....viii  
 Warnings .....viii

1 INTRODUCTION .....1  
 1.1 General .....1  
 1.2 System Description.....1  
 1.2.1 Sample Gas Path.....1  
 1.2.2 Operating Overview.....3  
 1.2.3 Condumax II User Display and Interface .....3  
 1.2.4 Calibration .....3  
 1.3 Condumax II Analyzer Storage Instructions.....4

2 INSTALLATION .....5  
 2.1 Electrical Safety .....5  
 2.1.1 Equipment Ratings and Installation Details.....5  
 2.2 Hazardous Area Safety .....8  
 2.3 Pressure Safety .....9  
 2.4 Lifting and Handling .....9  
 2.5 Measurement System .....10  
 2.5.1 Gas Connections, Sample Extraction & Conditioning .....11  
 2.5.2 Power Connection .....15  
 2.5.3 Analog and Digital Communications .....16  
 2.6 Condumax II Start-Up Purge Procedure .....17  
 2.7 Sample Gas Flows.....18  
 2.8 Sample Flow Alarms.....19

3 OPERATION .....20  
 3.1 Timing Synchronization.....20  
 3.2 Recovery Phase .....20  
 3.3 Measurement Phase .....20  
 3.3.1 Water Dew-Point Measurement .....21  
 3.3.2 Signal Changes and Trip Point.....21  
 3.3.3 Sensitivity Calibration .....22  
 3.3.4 Adjustment of Measurement Sensitivity to User Defined Reference .....23  
 3.4 User Interface.....24  
 3.4.1 Interface Controls .....24  
 3.4.2 'Up/Down Arrow' Buttons.....24  
 3.4.3 'SELECT' Button .....25  
 3.4.4 'MENU/MAIN' Button .....25  
 3.5 Menu Structure .....26  
 3.6 Main Page .....27  
 3.7 Menu Page .....27  
 3.8 Status Pages.....28  
 3.8.1 Status Page 1 .....28  
 3.8.2 Status Page 2 .....29  
 3.9 Logging Menu Page.....30  
 3.9.1 Logged Data Page.....30  
 3.9.2 Statistics .....31  
 3.9.3 Viewing Historical System Faults.....31  
 3.10 Adjusting and Viewing System Variables .....32

3.10.1	Enter Password .....	32
3.10.2	Variable Pages .....	32
3.10.3	Variables Page 1 .....	33
3.10.4	Variables Page 2 .....	33
3.10.5	Variables Page 3 .....	33
3.10.6	Variables Page 4 .....	34
3.10.7	Variables Page 5 .....	34
3.11	Sensitivity Calibration .....	35
3.11.1	Executing the Sensitivity Calibration .....	35
3.11.2	Viewing the Calibration Data .....	35
3.12	Water Dew-Point Sensor Information .....	36
3.13	Contact/About Information .....	36
4	MAINTENANCE .....	37
4.1	Calibration .....	37
4.2	Enclosure Cover and User Interface .....	38
4.3	Inspection/Cleaning of Hydrocarbon Sensor Cell Optical Surface .....	39
4.4	Replacement of the Hydrocarbon Sensor Cell Assembly .....	40
4.5	Replacement of the Water Dew-Point Sensor .....	41
4.6	Troubleshooting .....	42
4.6.1	Error Messages .....	42
4.6.2	Logged Error Codes .....	43
4.6.3	mA1 Output Analyzer Fault Alarm .....	44
4.6.4	Heat-Pump Depression .....	45
4.7	Field verification of HC dew point measurement .....	46

## Figures

Figure 1	Power Connection Connector .....	5
Figure 2	Earthing Stud And Nut Washer Assembly .....	6
Figure 3	Condumax Dimensions .....	10
Figure 4	Flow Schematic .....	11
Figure 5	Typical Phase Envelope for Northern Europe Natural Gas .....	14
Figure 6	Wiring Hook-Up Diagram .....	15
Figure 7	Minimum Requirements for Start-Up Purging .....	18
Figure 8	Sensitivity Calibration Plot (Example) .....	23
Figure 9	User Interface .....	24
Figure 10	'UP/DOWN ARROW' Buttons .....	24
Figure 11	'SELECT' Button .....	25
Figure 12	'MENU/MAIN' Button .....	25
Figure 13	Menu Structure .....	26
Figure 14	MAIN Page With Wdp Sensor Fitted .....	27
Figure 15	MAIN Page Without Wdp Sensor Fitted .....	27
Figure 16	MENU Page .....	27
Figure 17	STATUS Page 1 .....	28
Figure 18	STATUS Page 2 .....	29
Figure 19	LOGGED DATA Page .....	30
Figure 20	STATISTICS Page .....	31
Figure 21	Logged Error Codes .....	31
Figure 22	Password Page .....	32
Figure 23	Variables Page .....	32
Figure 24	Sensitivity Calibration Page .....	35
Figure 25	Sensitivity Calibration Data Page .....	35
Figure 26	Water Dew-Point Sensor Information Page .....	36
Figure 27	Contact/About Information Page .....	36
Figure 28	Error Messages .....	42
Figure 29	Logged Error Codes .....	43
Figure 30	Reading Holding Registers State Diagram .....	68
Figure 31	Write Single Register State Diagram .....	70

## Appendices

Appendix A	Technical Specifications.....	47
	A.1 Mounting Drawing.....	48
	A.2 Flow Diagram .....	49
	A.3 Wiring Hook-Up Diagram .....	50
Appendix B	Modbus RTU Communications .....	52
	B.1 Introduction .....	52
	B.2 Modbus RTU Basics.....	52
	B.3 Modbus RTU Basics.....	52
	B.4 Register Map .....	53
Appendix C	Software.....	57
	C.1 System Requirements.....	57
Appendix D	Variables Pages .....	59
	D.1 Variables Page 1 .....	59
	D.2 Variables Page 2 .....	61
	D.3 Variables Page 3 .....	62
	D.4 Variables Page 4 .....	63
	D.5 Variables Page 5 .....	65
Appendix E	Modbus RTU Details .....	67
	E.1 Message Framing.....	67
	E.2 Implemented Functions.....	68
	E.3 Exceptions.....	72
Appendix F	Number Formats .....	74
Appendix G	Hazardous Area Certification .....	80
	G.1 Product Standards.....	80
	G.2 Product Certification.....	80
	G.3 Global Certificates/Approvals.....	81
	G.4 Special Conditions of Use.....	81
	G.5 Maintenance and Installation .....	81
Appendix H	Quality, Recycling, Compliance & Warranty Information.....	83
Appendix I	Analyzer Return Document & Decontamination Declaration .....	85

## Safety

This manual contains all the required information to install, operate and maintain the Condumax II. Prior to installation and use of this instrument, this entire manual should be read and understood. Installation and operation of this product should be carried out by suitably competent personnel only. The operation of this product must be in accordance with the terms of this manual and associated safety certificates. Incorrect installation and use of this product for other than its intended purpose will render all warranties void.

This product is intended for use in a Hazardous Area and is ATEX, IECEx and UKCA approved. It is also approved for use in North America in accordance with the requirements for the USA and Canada. The relevant certificates should be fully examined prior to installation or use of this product.



**Where this hazard warning symbol appears in the following sections, it is used to indicate areas where potentially hazardous operations need to be carried out and where particular attention to personal and personnel safety must be observed.**

## Electrical Safety

The instrument is designed to be completely safe when used with options and accessories supplied by the manufacturer for use with the instrument. The input power supply voltage limits are 90...260 V AC, 47/63 Hz.

## Pressure Safety

DO NOT permit pressures greater than the safe working pressure to be applied directly to the instrument. Refer to the Technical Specifications in Appendix A.

## Toxic Materials

The use of hazardous materials in the construction of this instrument has been minimized. During normal operation it is not possible for the user to come into contact with any hazardous substance which might be employed in the construction of the instrument. Care should, however, be exercised during maintenance and the disposal of certain parts.

## Repair and Maintenance

The instrument must only be maintained either by the manufacturer or an accredited service agent. Refer to [www.michell.com](http://www.michell.com) for details of Michell Instruments' worldwide offices contact information.

## Calibration (factory validation)

Prior to shipment, both the hydrocarbon dew-point cell and the water dew-point cell undergo stringent factory calibration to internationally traceable standards – NPL (UK) and NIST (USA). Due to the inherent stability of the instruments, only periodic calibration maintenance is required under normal operating conditions. Refer to Section 1.2.4 and 4.1 for more information.

## Safety Conformity

This product meets the essential protection requirements of the relevant UK and EU directives. Further details of applied standards may be found in the product specification.

## Abbreviations

The following abbreviations are used in this manual:

AC	alternating current
atm	pressure unit (atmosphere)
barg	pressure unit (=100 kP or 0.987 atm) gauge
°C	degrees Celsius
°F	degrees Fahrenheit
DC	direct current
dp	dew point
EU	European Union
g/m <sup>3</sup>	grams per cubic meter
HCdp	hydrocarbon dew point
IEC	International Electrotechnical Commission
kg	kilogram
lb	pound
lbs/mmscf	pounds of water per million standard cubic feet of gas
m	meter(s)
mA	milliampere
max	maximum
mg/m <sup>3</sup>	milligrams per cubic meter
mm	millimeters
mV	millivolts
NI/min	normal liters per minute
Nm <sup>3</sup> /hr	normal cubic meters per hour
%	percentage
ppm <sub>v</sub>	parts per million by volume
psig	pounds per square inch
RS232	serial data transmission standard
RS485	serial data transmission standard
RTU	Remote Terminal Unit
scfh	standard cubic feet per hour
temp	temperature
V	Volts
W	Watts
Wdp	water dew point
Ω	Ohms
"	inch(es)

## Warnings

The following general warnings listed below are applicable to this instrument. They are repeated in the text in the appropriate locations.



**Where this hazard warning symbol appears in the following sections it is used to indicate areas where potentially hazardous operations need to be carried out.**



**Where this symbol appears in the following sections it is used to indicate areas of potential risk of electric shock.**

## 1 INTRODUCTION

### 1.1 General

The Condumax II is designed for continuous, automatic measurement of the hydrocarbon dew point and water dew point of processed natural gas. It is the result of more than 30 years' experience in the supply of analyzers to the worldwide oil, gas and petrochemical industry.

The system consists of a hydrocarbon dew-point measurement sensor cell and control electronics housed in an Exd enclosure. An optional water dew-point measurement sensor can be accommodated, either at the time of build or as a retro-fit option. A sample gas handling panel to prepare the gas sample prior to entry into the Condumax II can also be supplied. The analyzer is designed to be positioned close to the process sample point. It is ATEX, IECEx and UKCA approved and is also approved for use in North America in accordance with the requirements for the USA and Canada. These and additional international approvals are listed in the Certification section of this manual. Certificates are available on the Michell Instruments website. A marking label located on the analyzer will identify appropriate approvals.

The unique measurement principle of the Condumax II involves detecting the formation of hydrocarbon condensate through a highly sensitive secondary optical effect. A reduction in scattered light intensity is observed when a well-collimated incident light beam is reflected from a shallow, abraded, conical depression by hydrocarbon condensate forming on the measurement surface. This measurement surface is referred to as the Optical Surface (see Section 3.8.1). The cooling of the measurement surface is achieved using a Peltier effect (thermo-electric) heat pump. The use of this device enables measurements to be made down to more than 50 °C below the operating temperature of the analyzer.

The Condumax II operates on a periodic measurement cycle basis. The sample flow is continuous until, at the start of a measuring cycle, the flow is interrupted, trapping a sample of gas within the sensor cell until the dew point is measured.

This technique of analyzing a fixed volume sample successfully de-couples thermal mass transfer and flow effects on the observed dew point ensuring that repeatable measurements are made to a constant level of measurement sensitivity.

### 1.2 System Description

The requirements for operation are a 90 to 260 V AC, 47/63 Hz power supply of 125 W and field communications; Modbus RTU and/or 4...20 mA. Refer to the 'Wiring Hook-Up Diagram' in Appendix A.3.

#### 1.2.1 Sample Gas Path

The Condumax II measurement system must be supplied with gas at the required pressure via a sample gas handling panel. The hydrocarbon dew-point stream is always included as part of the system and, as an additional option, the water dew-point stream can be fitted. Sample gas entry and exit ports pass the gas through flame arrestors which provide the explosion proof protection.

The measurement system components are housed within a cast aluminum EExd rated enclosure. The enclosure has a screw cover incorporating a sealed window. It is chromate primed, polyester coated in black, and provides environmental protection to IP66/NEMA 4. An enclosure breather is fitted in the form of an additional flame arrestor. It is important that no pipe connection is made to this breather and that no restriction is allowed to occur.

All sample wetted metallic parts are manufactured in AISI 316L stainless steel with Viton soft parts that comply with the NACE standard MR-01-75 (latest edition). Tube fittings are twin ferrule compression type. All electrical and gas connections are made through the base of the enclosure. Refer to the Mounting Drawing in Appendix A.1.

The hydrocarbon dew-point flow components are as follows (refer to the 'Flow Diagram' in Appendix A.2):

- **Flow Switch 1**

Provides indication that a flow is present throughout the hydrocarbon dew-point measurement stream.

- **Hydrocarbon Dew-point Sensor Cell**

Provides the measurement of hydrocarbon dew point within the sample gas.

- **Pressure Transmitter 1**

Provides the measurement of the sample gas pressure within the hydrocarbon dew-point measurement cell.

- **Solenoid Valve**

Enables sample gas shut off to provide fixed volume measurement.

The water dew-point flow components are as follows:

- **Flow Switch 2**

Provides indication that a flow is present throughout the water dew-point measurement stream.

- **Pressure Transmitter 2**

Provides the measurement of the sample gas pressure within the water dew-point measurement cell.

### 1.2.2 Operating Overview

At the beginning of a measurement cycle, the sample solenoid valve is closed to trap a gas sample in the hydrocarbon sensor cell for analysis and the controlled cooling of the optical surface commences. When the scattered light intensity, measured by the optical measurement system, reaches a user-set trip point, the temperature of the optical surface is recorded as the hydrocarbon dew point. After this, the sample gas flow is restored and the optical surface is heated to the temperature set-point. The heating of the optical surface to an elevated temperature ensures that any hydrocarbon residue is released from the optical surface before the next measurement cycle.

This measurement process is repeated cyclically at intervals determined by the control system and pre-set by the operator. The minimum cycle time is 10 minutes and under ideal conditions, when the condensate formed is sufficiently volatile to evaporate the residue, the recovery phase will be approximately 8 minutes. However, in applications where relatively high hydrocarbon dew points occur (within 10 °C of saturation at the sampling system temperature) then longer cycle times may be required in order to avoid residue build-up on the optical surface.

The measurement of the water dew point is continuous and the gas sample flow is uninterrupted.

The measured hydrocarbon and water dew-point temperature, pressure, date and time are stored and indexed in the memory, with the most recent reading logged as number 1. The temperature and pressure readings are available via both the digital and analog communications. The date and time are only available through digital communication.

### 1.2.3 Condumax II User Display and Interface

The Condumax II User Display and Interface Unit is presented via the circular window of the enclosure. Operation is achieved by a unique system which allows full control through the glass of the enclosure cover. The cover is fully detachable for greater access into the enclosure during the installation and initial set-up of the instrument. During normal operation of the instrument the cover must remain fully secured.

### 1.2.4 Calibration

The Condumax II is factory-tested and calibrated prior to delivery. Certification is provided for the hydrocarbon dew-point sensor and the optional water dew-point sensor, if fitted.

The hydrocarbon dew-point sensor is calibrated at three points across its operating range using a certified gas mixture of 10% (mol) n-butane in pure nitrogen. The calibration gas is a gravimetric mixture produced using weights traceable to National Physical Laboratory (NPL). Calculation of the relationship between calibration gas pressure and hydrocarbon (n-butane) dew-point temperature is determined using the Peng/Robinson equation of state. The sensor is also performance tested against samples of synthetic natural gas, to confirm the correct optical response to multiple condensable components. These speciality gas mixtures are analyzed by a UKAS accredited laboratory in accordance with BS EN ISO 17025.

The water dew-point sensor is supplied with its own Calibration Certificate, providing direct traceability to both UK (NPL) and US (NIST) Humidity Standards. The sensor is certified at 7 dew-point levels across its operating range against a certified reference hygrometer, using a mass-flow humidity generator system as a source of reference calibration gas (refer to Section 4.1 for details on calibration maintenance).

### 1.3 Condumax II Analyzer Storage Instructions

The Condumax analyzer has been designed for the accurate measurement of hydrocarbon and water dew point within natural gas. In order for the analyzer to be functional upon installation it should be stored in accordance with the guidelines below:

- The analyzer must be housed in a sheltered area, out of direct sunlight and rain.
- The analyzer should be stored to minimize the possibility of sitting in ground water.
- The temperature within the storage environment should be maintained between 0 and +50 °C (+32 and +122 °F).
- The humidity within the storage environment must be non-condensing.
- The storage environment must not expose the analyzer to any corrosive elements.
- The analyzer may stay assembled with its sample conditioning system (if supplied).
- All electrical and process connections should remain disconnected.
- All protective coatings should remain in place until installation.
- For prolonged periods of storage, the lid of the packaging crate should be removed to allow air to circulate.
- The documentation supplied with the analyzer should be removed from the packaging crate and stored elsewhere to protect its integrity.

For the period from installation of the Condumax II analyzer to commissioning start-up, the following precautions should be followed:

- The analyzer and associated sampling system must remain isolated from the process gas, and the enclosure should remain closed to ensure ingress protection is maintained.
- The sampling system enclosure heating/thermostat circuit should be operated if the climatic temperature might fall below 0 °C (+32 °F).
- At time of start-up the procedures contained in the User Manuals for both analyzer and sampling system must be followed.

If the Condumax analyzer was previously in service/operation then the following precautions should be followed before storage:

- Upon isolation from the gas sample the entire system should be purged with a dry nitrogen gas before powering down of the analyzer.
- All connections and ports (gas and electrical) to the analyzer or sample system (if provided) should be capped.
- If the analyzer is not removed from its location, the electrical grounding of the analyzer should remain in place.

**2 INSTALLATION**

**2.1 Electrical Safety**

**WARNING:**  
 During the installation of this product ensure that all applicable national and local electrical safety regulations are observed.



**WARNING:**  
 Isolate the power prior to installation.

**WARNING:**  
 Always ensure that power is switched off prior to accessing the product for any purpose other than normal operation or prior to disconnecting any cables.

**2.1.1 Equipment Ratings and Installation Details**

The following mandatory statements refer to the Ex certified Condumax Analyzer only (not including the sampling system).

This equipment must be supplied with a voltage between the range of 90 to 260 V AC, 47/63 Hz. Maximum power rating is 125 W.

The power is connected via PL1 on the mains connector PCB.

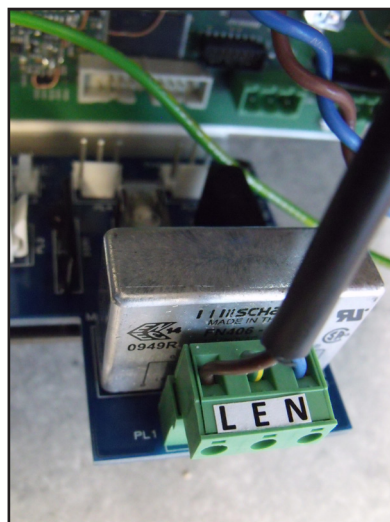

**Figure 1** *Power Connection Connector*

All input and output connectors are 2-part PCB mounted type, rated at 300 V 10 A.

The detachable, screw terminal half of each connector is designed to accept 0.5 to 2.5mm<sup>2</sup> [24 -12 AWG] stranded or solid conductors.

Any power connection cable should be 3 core over sleeved, with minimum 0.5mm insulation and rated at 300 V. Cables should have Live (L), Neutral (N) and Earth [Ground] (E) conductors. Ensure suitably rated power supply cables and glands are used to ensure that electrical safety is maintained. Connect each of the Live (L), Neutral (N) and Earth [Ground] (E) conductors to the similarly marked terminals (L, N, E) on the Power In connector shown in Figure 1. Ensure the power supply can deliver sufficient power consumption requirement.

Any power supply terminals and voltages must be suitably separated from the other I/O requirements of this product.

Before applying power, perform a continuity test to ensure that the power supply cable and product are effectively connected to the protective Earth.

The Protective Earth terminal is mounted internally and the Earth wire connected to it should never be disconnected. The product enclosure is supplied with an external earth stud at the lower right hand side. At installation, connect this earth stud to plant earth by a minimum 4mm<sup>2</sup> earthing bonding. M6 stud and 2 off M6 nuts and washers, all nickel plated.



**Figure 2** *Earthing Stud And Nut Washer Assembly*

Fuse: A replacement fuse can be obtained by contacting Michell Instruments' technical support. Fuse rating = 5 x 20mm 2.5 A anti-surge to IEC 60127-2.

This product is designed to operate, as a minimum, between a temperature range of -40 to +60 °C, in maximum 80% relative humidity for temperatures up to +31 °C decreasing linearly to 50%rh at +50 °C. Supply voltages of ±10% and transient over voltages up to Overvoltage Category II. Pollution Degree 2. Altitudes up to 2000m. Outdoor mounting is permitted using suitably rated glands equivalent to NEMA 4 / IP66. See Appendix A, Technical Specification for full operating parameters.

Do not remove or exchange any of the cables or electrical components supplied with this product. Doing so will invalidate all warranties.

There are no additional or special electrical safety requirements other than those referred to in this manual.

Location and mounting arrangements – refer to the relevant sections of this manual for the location and mounting details.

Installation of this equipment must include the provision of a suitable and locally positioned power isolation switch or circuit breaker. Indication of the purpose of the switch or circuit breaker is strongly recommended. An over-current protection device should be rated to a maximum of 10 A.

This equipment and all power isolation devices must be installed in a location and position that allows safe and easy access to their operation and is able to rigidly support the equipment.

Do not install this equipment in a location that would expose it to impact or high levels of vibration.

Operation of this equipment, other than in a manner specified by the manufacturer, may impair the safety protections provided.

The safe installation of this equipment and any system incorporating this equipment is the responsibility of the installer. Ensure local regulations and requirements are referred to prior to any installation commencing.

**2.2 Hazardous Area Safety**

Refer to Appendix G for the Hazardous Area Certification of this product.

This product is fitted with a marking label that contains Hazardous Area information pertinent to the suitable location and installation.

During all installation and operation activities, local regulations and permitted working routines must be observed. Installation should only be performed by competent personnel and in accordance with the latest version of IEC/EN60079-14 or local equivalent.

Repair and servicing of this equipment must only be carried out by the manufacturer.

An Installation and Maintenance Information Sheet is supplied separately to the manual.



**WARNING:**  
**This product is certified safe for use in a Zone 1 and Zone 2 area only. This product must not be installed or used within a Zone 0 area.**

**WARNING:**  
**This product must not be operated within an explosive atmosphere greater than 1.1 bara.**

**WARNING:**  
**This product must not be operated with enriched oxygen gas samples (more than 21% oxygen content).**

**WARNING:**  
**This product should not be operated outside its certified temperature range. Check the attached instrument marking plate for the appropriate information.**

**WARNING:**  
**The enclosure of this product provides Exd protection, partly through the threads used for mounting the lid, stopping plugs and cable gland. At all times effort should be made to ensure these threads are suitably protected from damage and that only appropriately rated mating parts are applied to them, in accordance with the certifying requirements.**

## 2.3 Pressure Safety



**WARNING:**  
This product is used in conjunction with pressurized gases.  
Observe pressurized gas handling precautions.



**WARNING:**  
Pressurized gas is dangerous.  
Pressurized gas should only be handled by suitably trained personnel.

This product requires pressurized gas to be connected to it. Observe pressurized gas handling regulations. Only suitably trained personnel should carry out tasks that include the use of pressurized gas mediums.

## 2.4 Lifting and Handling



**WARNING:**  
This instrument is in excess of 18kg (40lbs).  
Personnel must observe suitable lifting and handling precautions.

This product is not designed as portable or transportable equipment. It should be rigidly fixed in position as per the full installation instructions.

The weight of the analyzer is in excess of 18kg (40lbs). Therefore, appropriate lifting and handling techniques should be used during the installation process. Before commencing any lifting or handling ensure that its intended location is suitable and appropriately prepared. Make sure that mounting point design considerations have employed locally approved safety factors.

When handling and installing this product (particularly after removal from its packaging) ensure that it is not dropped, impacted or subjected to high levels of vibration or environmental conditions that may impair its operation.

## 2.5 Measurement System

Refer to the Installation & Maintenance Information sheet (supplied separately) and the System Drawings in Appendix A.

The instrument is housed in an aluminum EExd enclosure suitable for wall or panel mounting. Four mounting points are available with M12 clearance holes on fixing centres of X = 270mm (10.62") x Y = 318mm (12.51").

The dimensions of the enclosure are:

Height: 355mm (13.9"), 500mm (19.68") including installation clearance  
 Width: 310mm (12.20"), 500mm (19.68") including installation clearance  
 Depth: 245mm (9.64")

The enclosure provides environmental ingress protection IP66/NEMA 4 and should be mounted vertically in a location free of any appreciable vibration. It should be placed in a shaded position to prevent heating effects through sun radiation.

The weight of the analyzer is 25kg (55lbs).

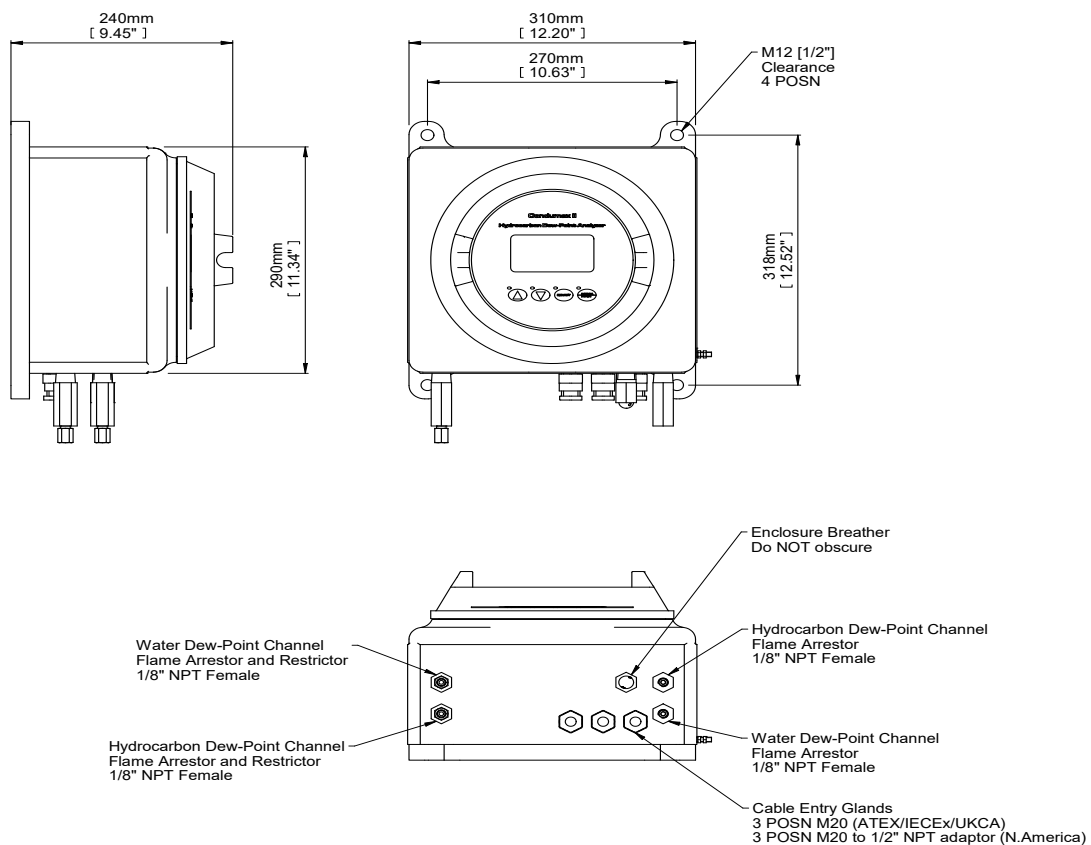

**Figure 3** Condumax Dimensions

2.5.1 Gas Connections, Sample Extraction & Conditioning

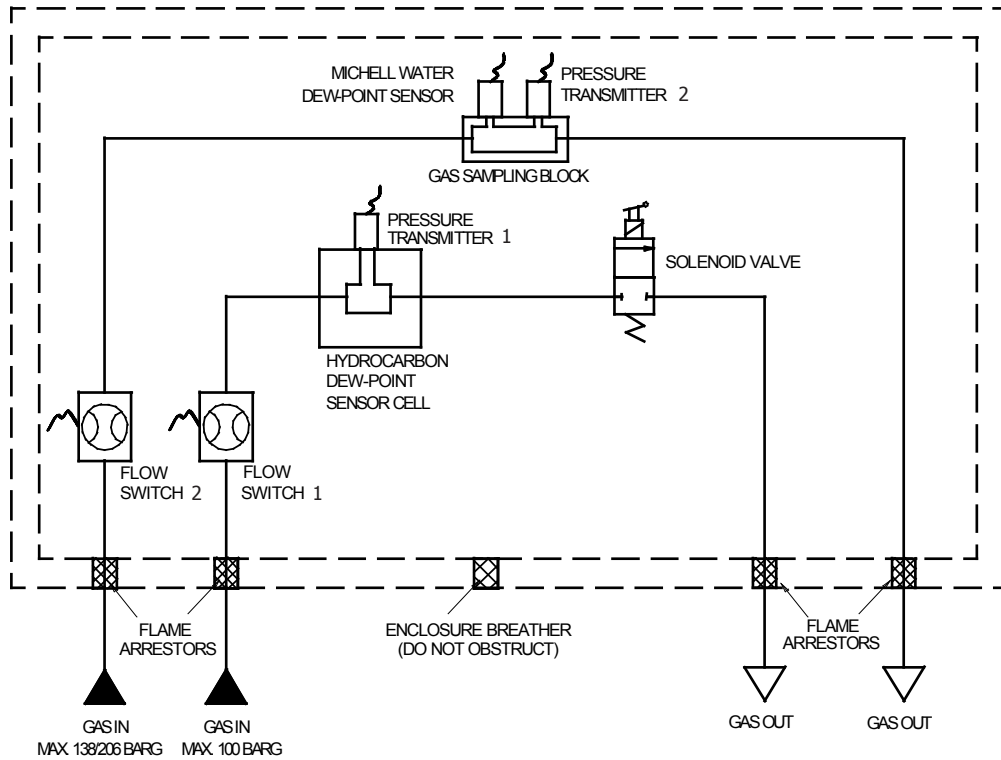

Figure 4 Flow Schematic

**NOTE:** Ensure that the process sample gas supply line is well flushed through to clear any liquids and debris present prior to connection to the instrument. A sample handling system must prepare the gas in terms of pressure regulation and filtration before entering into the measurement system.



In accordance with the certification requirements for safe operation of this product, the Condumax II must have, as a minimum, those components described in Section 2.7 and positioned as shown in Appendix A.1.

The pipe work connections are as follows:

<b>Hydrocarbon gas sample inlet</b> (Maximum pressure of 100 barg (1450 psig))	1/8" NPT Female (ATEX/IECEx/ UKCA/QPS)
<b>Hydrocarbon gas sample outlet</b> (Vent to atmosphere or low pressure flare line)	
<b>Water dew-point gas inlet</b> (Maximum pressure of 138 barg (2000 psig))	
<b>Water dew-point gas outlet</b> (Vent to atmosphere or low pressure flare line)	

The following points should be considered when installing the sample gas supply line:

PTFE tape is recommended for pipe connections. Solvent based pipe thread sealant should not be used, as condensable components or contaminants can be leached during the curing period.

It is recommended that Viton is used for all O-rings.

Care and attention to the position and installation of the piping will minimize problems caused by avoidable contamination of the measurement system. The most common cause of difficulty is the accumulation of liquid in impulse lines during a shutdown period. If the measurement system has not been isolated on restart-up, condensate can be displaced into components and associated pipe work within the measurement system.

If this event follows a period when process lines may have been contaminated by non-hydrocarbons e.g. glycol, corrosion inhibitors etc., the problem is magnified. Similarly, difficulty will be encountered in sample gases carrying liquids, including hydrocarbon liquids.

Our recommendations are:

- The sampling point on the process line should be on the top of the pipe. If a radial probe is used the orifice should face downstream.
- The internal volume of the impulse tubing between the process line and any sampling system should be as low as possible to minimize response lag time to changing process conditions.
- Piping should be lagged and/or trace heated if ambient temperatures could cause the sample gas to fall below its dew-point temperature.
- A drain valve should be placed at the low point (if any) in the system.
- It should be standard procedure to isolate the measurement system during shutdowns or when plant problems are being experienced and to properly purge the supply lines before restarting.
- The relatively large area of surfaces and internal volume of pressure regulators can be particularly troublesome if contamination is experienced. Prolonged purging with gas may be necessary to remove the contamination. Stripping and cleaning followed by purging of the system is preferred.
- Avoid sample gas streams that are already very close to the dew point or which have dispersed liquid (not necessarily hydrocarbon) burden. In such cases, sampling from fast loops and/or from downstream of existing catch pot/coalesce systems is always preferred.

Failure to observe these recommendations will potentially cause problems of contamination as well as causing consequential inaccurate, unreliable and inconsistent monitoring. If a top-entry sample point is not available, extra attention should be given to the design of the sample line installation to avoid unwanted contamination.

### Sample Extraction and Conditioning

Sample extraction, handling and conditioning techniques are of critical importance to assure optimal performance and reliability of all gas analyzers which accurately quantify specific components within a process gas composition. Michell Instruments' recommendations and requirements in relation to the Condumax II are outlined below. Michell Instruments offers a range of sample conditioning systems which are designed to exceed these minimum requirements. For further information and advice please contact your local Michell office or distributor – See contact details on [www.michell.com](http://www.michell.com).

### Sample Extraction and Impulse Tubing

An insertion probe, with tip positioned within the central 1/3rd of the cross sectional area of the pipe, should be used to derive a sample composition that is representative of the majority of gas flowing within the pipeline.

Attention should be given to the installation of impulse tubing connecting from sample probe to the analyzer sample conditioning system. Analytical grade acid-etched stainless steel tubing should be used, which has a low moisture sorption capacity. Tube size should not be larger than 1/4" or 6mm outside diameter to ensure that sample transportation delay time is kept to a minimum. Likewise, to ensure best dynamic response of the complete installed analyzer system, the positioning of the analyzer with sample conditioning system should be as close as possible to the sample extraction probe.

To avoid any risk of condensation forming during transportation to the analyzer, and so ensure the integrity of the sample gas is maintained, the temperature of the sample impulse tubing must be maintained at a temperature above the highest envisaged water dew point. It is recommended that the sample tubing temperature is maintained at least 5 °C (10 °F) above the maximum water dew point at the prevailing pressure, as a suitable 'safety margin'. Self-limiting heating cable should be applied to the complete length of the impulse tube, enclosed within suitable insulation. The power rating of heating cable should be selected to achieve the required maintained temperature given the minimum climatic temperature at the installation location. For convenience during installation, a number of leading process electric heating companies offer tube 'bundles' comprising instrumentation tubing, self-limiting heating cable, insulation and protective outer sheath. Trace heated tube bundle is a factory fitted option for Michell produced sample conditioning systems.

### Sample Conditioning

The sample conditioning system must address the needs for filtration, pressure reduction and sample flow control.

To maintain cleanliness of the analyzers optical detection system, the process sample flow must be filtered to eliminate entrained liquids and particles. To provide protection against HC condensates and compressor oils that may be present in process natural gas, it is recommended to use micro-porous membrane filtration with an oleo-phobic element specifically intended to reject such low-surface tension liquids.

Pressure reduction and sample flow control is required to achieve the desired analysis pressures and the stated sample flow requirements of the analyzer – see Section 2.7. Care should be taken to counteract though directly applied heating the Joule-Thomson cooling effect of sample expansion to reduced pressure. Established business practice at custody transfer is to measure water dew point at full line whilst HC dew point is determined at intermediate pressure, commonly 27 barg (400 psig), the cricondentherm condition at which HC dew point temperature will be highest on the retrograde phase envelope – see figure below:

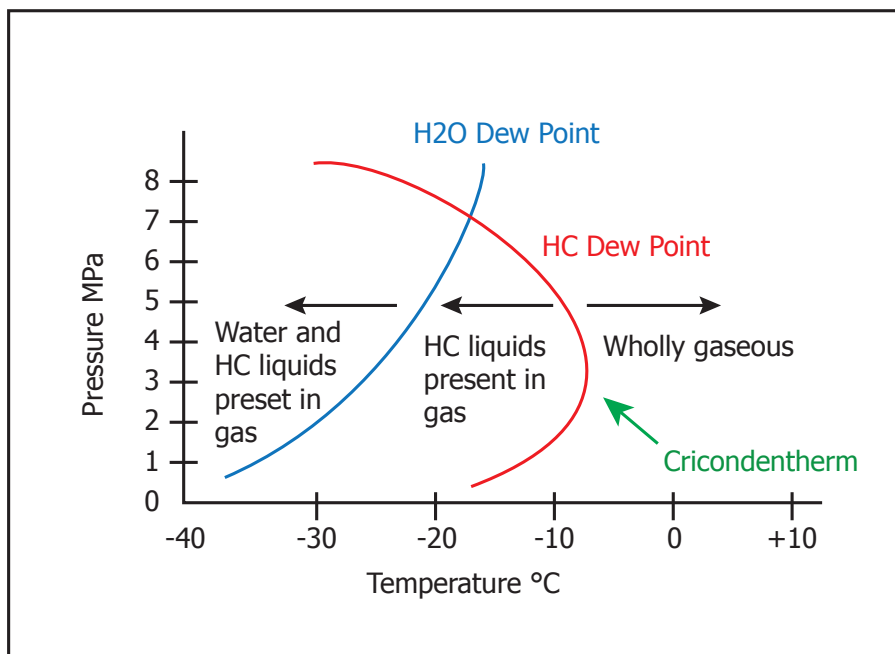

**Figure 5** Typical Phase Envelope for Northern Europe Natural Gas

As with the sample impulse tubing, the sample conditioning system (SCS) must be maintained at a temperature above the highest expected water and HC dew point at the prevailing process sample pressure and the analysis pressure for HC dew point, either by housing the SCS together with the analyzer within a heated and thermostatic controlled, insulated enclosure, or by positioning in a suitable indoor environment. The enclosure for outdoor installed systems must be located within 100% shade from direct sun, if necessary by the addition of an effective sun canopy with walls on three sides.

As with all precision analytical equipment, it is desirable to maintain a moderate operating temperature. In the specific case of a HC dew-point analyzer, care should be taken not to elevate the analyzer operating temperature higher than is necessary to maintain sample integrity. Given the principle of cooled-mirror dew-point measurement, the measurement range of HC dew point is limited by a cooling depression range capability. In the case of the Condumax II, the lower range capability is  $\geq 50$  °C from the prevailing analyzer operating temperature. When the analyzer system is installed outside in hotter climate installation locations, or where the application requires measurement near or below the measurement cooling depression limit, it may be necessary to provide auxiliary cooling within the system enclosure. Such cooling can be achieved using a compressed air driven vortex tube controlled by an adjustable thermostat.

2.5.2 Power Connection

A single-phase AC power connection is required.

The power supply can accommodate voltages from 90 to 260 V AC, 47/63 Hz. The unit requires a maximum of 125 W to function correctly.

Cable entry into the measurement system is made through the bottom of the enclosure.

- For ATEX/IECEX/UKCA compliant versions of the product, 3 off ISO M20 tapped holes are provided.
- For cQPSus compliant version of the product, 3 off M20 -> 1/2" NPT thread adaptor are provided.

Power connections are made via a removable screw terminal connector mounted on the mains connection PCB.

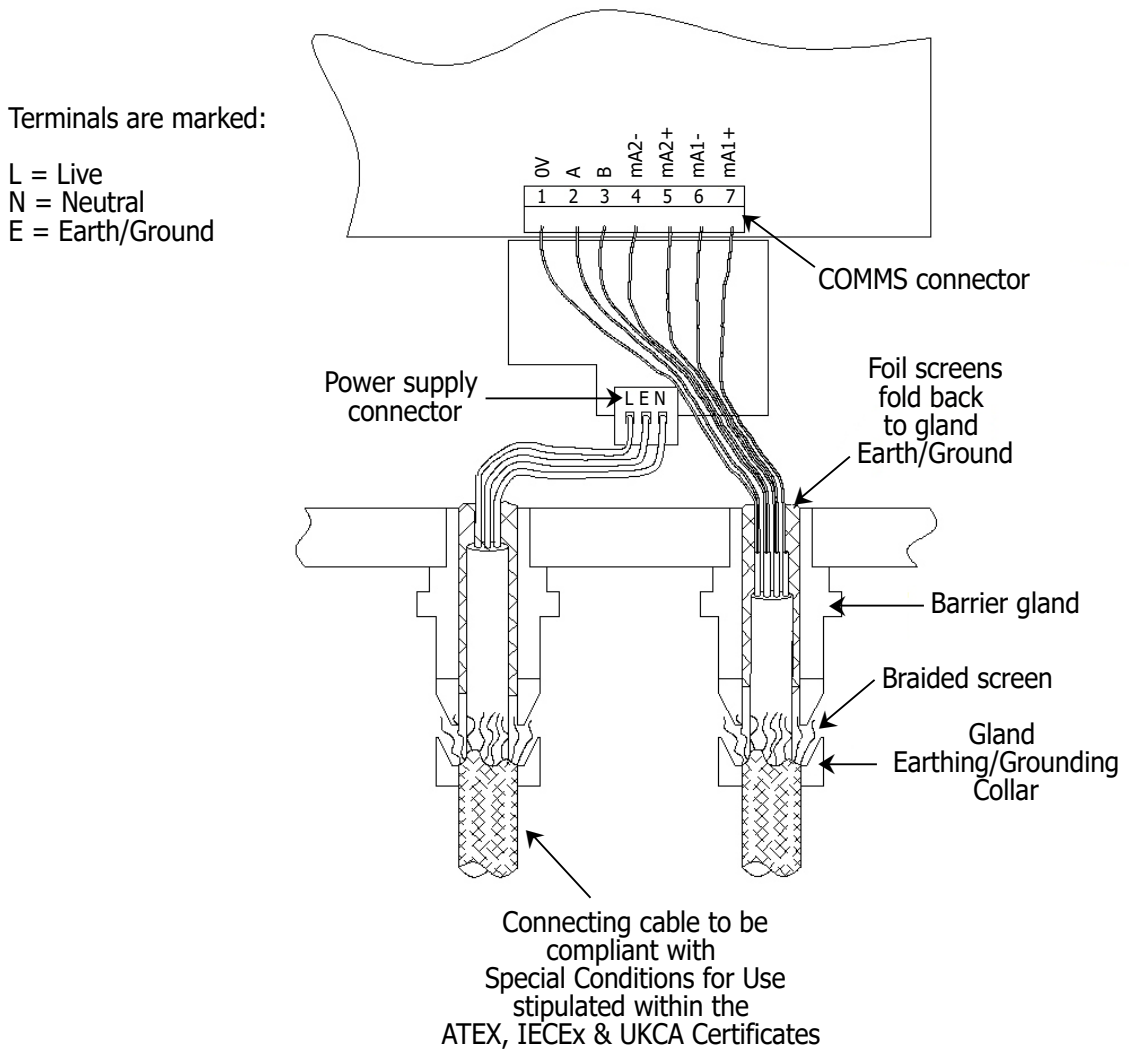

Figure 6 Wiring Hook-Up Diagram

### 2.5.3 Analog and Digital Communications

Two active 4...20 mA outputs and a Modbus RS485 digital interface (see Appendix B for details) are provided with the Condumax II. The 4...20 mA outputs can be set individually to represent one of the following:

- Hydrocarbon dew point (or signal in mV if in condensate mode)
- Hydrocarbon dew-point analysis pressure
- Water dew-point analysis pressure
- Water dew-point temperature (or moisture content)

**NOTE: The maximum output resistance for the 4...20 mA outputs is 500  $\Omega$ .**

Refer to Section 3.10.4 for the setting of the 4...20 mA outputs via the user interface and refer to Appendix B.4 on setting the outputs via the Modbus interface.

## 2.6 Condumax II Start-Up Purge Procedure

This is a mandatory procedure stipulated in the ATEX/IECEX/UKCA certification of the product. The procedure must be fully carried out prior to the Condumax II having any power or signal connections applied. It must also be fully carried out after the Condumax II and associated gas handling equipment has been installed and leak checked. Always refer to Appendix G.4 – Special Conditions of Safe Use.



This procedure must be carried out at any time following service or maintenance periods that cause any of the Condumax II or associated gas handling equipment pipe work to be disconnected.

It is not necessary to carry out this procedure if power or signal connections only, have been disconnected.

1. Before start-up, ensure that all power and signal connections to the Condumax II are fully isolated.
2. Ensure that all inlet & outlet gas connections to the Condumax II are correct and leak tight checked.
3. Fully open the flow control valve of the flowmeter on the hydrocarbon dew-point channel and, if also fitted, the water dew-point channel.
4. Set the solenoid valve to the **PURGE** position (fully screwed in clockwise) by using the **manual override operating adjuster** mounted on the base of the solenoid valve body. Indication of the manual override position is shown on a label attached to the solenoid. Access to the solenoid valve is obtained by removing the enclosure cover. Refer to Section 4.2 for removal and refitting of the enclosure cover.



The manual override operating adjuster is provided only to allow initial system set-up and purge in an unpowered condition. This manual override adjuster must never be operated while in a pressure induced condition. The manual operation of the valve is not required for the normal operating cycle of the system.

5. Fully open the sample gas inlet isolation valve.
6. Gradually open the pressure regulator until full scale flow is observed on the hydrocarbon dew-point channel flowmeter and the water dew-point channel flowmeter, if fitted.

7. Allow the sample gas to purge the system for the period of time indicated below:
  - Total purge time must be a minimum of 2 minutes at 0.5 NI/min (0.03 Nm<sup>3</sup>/hr) (1 scfh).  
Assumes total system (see diagram below) pipe length is 3m (9.8ft) and internal pipe bore is the recommended 4mm internal bore.
  - For every additional meter of 4mm internal bore pipe work of a sampling system, continue the gas purge for an additional 30 seconds at 0.5 NI/min (0.03 Nm<sup>3</sup>/hr) (1 scfh).
8. After the appropriate purge duration the gas inlet isolation valve may be closed.
9. Return the manual override valve adjuster on the Solenoid to the **NORMAL OPERATING** position (fully unscrewed counter-clockwise).
10. The enclosure cover may now be replaced. **NOTE: Before any power or signal lines are connected the enclosure cover must be fully fitted.**
11. After the enclosure cover has been refitted the Condumax II is ready for immediately start-up. **NOTE: If start-up is delayed then the purge procedure must be repeated.**

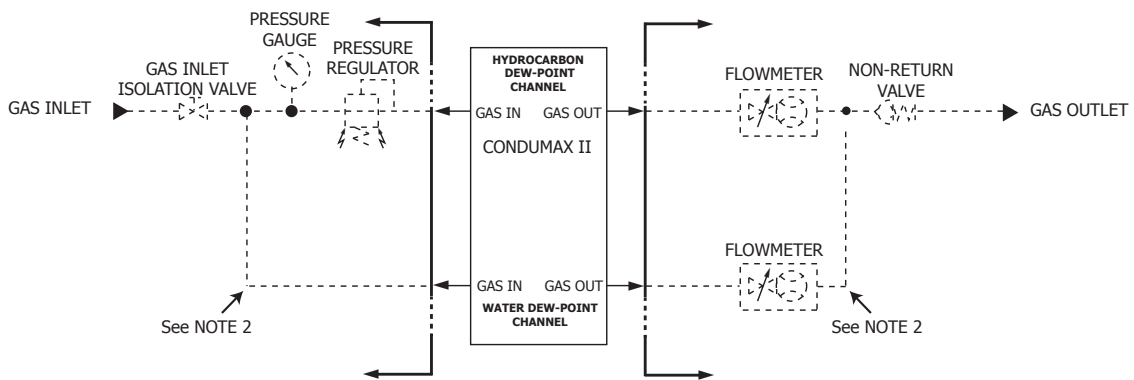

NOTE:  
 1. Connecting pipework to be 4mm I/D bore, 316L stainless steel tube  
 2. Components and pipework only required if water dew-point channel is installed into Condumax

**Figure 7** Minimum Requirements for Start-Up Purging

## 2.7 Sample Gas Flows

The sample gas flows for the system should be set as follows:

- For the hydrocarbon dew-point channel it is recommended that a flow of approximately 0.5 NI/min (0.03 Nm<sup>3</sup>/hr) (1 scfh) is set. During the measurement cycle the sample gas flow is isolated as the measurement is made in a static flow condition.
- To increase the speed of response of the measurement of the main process gas it is highly recommended that a fast bypass loop is installed into the gas sampling system. The bypass flow should be derived from the drain port of a combined coalescing and membrane filter offering protection from contamination of the analyzer in the event of liquids being present in the process gas sample. The recommended flow through the bypass loop should be typically 3...4 NI/min (0.18...0.24 Nm<sup>3</sup>/hr) (6.3...8.5 scfh).
- If a water dew-point channel is fitted, the gas flow through its sensor should be set at approximately 1 NI/min (0.06 Nm<sup>3</sup>/hr) (2.1 scfh).

## 2.8 Sample Flow Alarms



**The flow switches are supplied to alert the user to either severely reduced or discontinuation of sample gas flow through the system.**

An alarm state will be indicated on the Error Message line at the bottom of the **MAIN** display. Refer to Section 4.6 for further details.

After the correct flow of sample gas is set, the alarm states will be indicated when the gas flow has fallen below that required to make effective measurements.

The flow switches fitted are adjusted during factory test to activate the alarm when the flow falls below approximately 20 to 10% of the normal recommended sample flow setting (see Section 2.7). During the factory setting procedure the gas pressure that is applied represents the most common application analysis conditions for hydrocarbon (27 barg (391 psig)) and water (68 barg (986 psig)) dew-point sensors.

The operation of these variable area flow switches are influenced by pressure. For increased pressure the flow alarm activation point will be at a higher flow rate and conversely, for reduced pressure, the activation point will be at a lower rate. These devices exhibit a hysteresis that may require a flow of greater than 100% of the recommended flow setting for a brief period in order to clear the alarm condition.

**NOTE: If the Condumax II main unit is going to be operating with significantly different analysis pressures to those used during factory testing, then fine re-adjustment of the flow switches may be beneficial to suit the application conditions. If this is the case contact Michell Instruments ([www.michell.com](http://www.michell.com)) for guidance as to how adjustments can be made on site.**

### 3 OPERATION

At switch-on, the system synchronizes to the on-board real-time clock, heats the optical surface to the set-point temperature and adjusts the optical levels to give a signal level of 0.00%. When the 'next measurement' time counts down to 0 minutes and 0 seconds, the measurement cycle commences and the system cools the optical surface at a controlled rate until the signal level increases to 100% of the trip point. Once reached, the optical surface temperature is recorded as the hydrocarbon dew point, along with the hydrocarbon channel pressure, water dew point (if this option is fitted) and water channel pressure. The optical surface is then heated to the set-point and the optics level is re-adjusted to give a signal level of 0.00%. The cycle is repeated continuously at 'cycle time' intervals, which are factory set at 10 minute intervals but may be user adjusted.

#### 3.1 Timing Synchronization

At switch-on, the instrument will display the **MAIN** page (Section 3.6) and synchronize itself to the on-board real time clock, in order to start the measurement cycles at a time (hrs:mins) that is divisible by 10 – i.e. 10, 20, 30, 40, 50 or 60 (0). If the first start time is less than 2 minutes away, then the system will start measurements on the next permissible start time. For example, if the instrument is switched on at 6 minutes past the hour, then the instrument will take its first measurement at 10 minutes past the hour. However, if the instrument is switched on at 9 minutes past the hour, then the first measurement will begin at 20 minutes past the hour, to ensure there is enough time for the system to auto-calibrate itself.

#### 3.2 Recovery Phase

Auto-calibration commences at switch-on and after every measurement cycle. The sensor mirror is heated to the mirror temperature set-point and the optics level is adjusted to give a signal level of 0.00%. This procedure is shown on the **STATUS** Page where the mirror temperature, signal and optics values can be observed.

#### 3.3 Measurement Phase

The Condumax II can be set to function in one of 2 modes – Condensate Mode and Measurement Mode are mutually exclusive. One is the inverse of the other.

**Measurement Mode:** HC dew-point temperature at a set trip point (threshold for signal change, mV). This is the normal operating mode for the analyzer.

**Condensate Mode:** Signal change (mV) at a customer set cooling trip temperature. This mode can be applied temporarily by the user if harmonization of HC dew-point temperature measurement sensitivity to a desired reference value is required. As an example, the Trip Temperature could be set to the user's reference HC dew point temperature in order to determine, through a series of Condensate Mode measurements, the Signal Change 9mV0 setting required in order for Condumax II to replicate the same measured value in normal Measurement Mode operation. For further information refer to section below.

- **Measurement Mode**

When the phase duration time reduces to 0 minutes and 0 seconds, as shown in the bottom line of the **MAIN** and **STATUS** Pages, the system will deactivate the internal sample solenoid valve to stop the gas sample flow and reduce the temperature of the mirror at a controlled rate until the signal level has increased to 100% of the signal level trip point (refer to Appendix D.1). Once this detection threshold is reached the optical surface temperature will be reported as the HCdp.

During every measurement cycle, and based on the previous measurement, the optical surface temperature ramp rate is optimized to be at 0.05 °C/sec at the point of hydrocarbon dew-point measurement.

After the signal trip point has been reached, the system will re-enter the Recovery Phase, control the temperature of the optical surface to the set-point, adjust the signal level to 0.00% and count down to the next Measurement Phase.

- **Condensate Mode**

When the phase duration time reduces to 0 minutes and 0 seconds, the system will deactivate the internal solenoid valve and cool the optical surface at a controlled rate until the the user set trip temperature is reached. This mode provides a method to observe signal change to a defined temperature (user-set trip temperature – refer to Appendix D.1), whereby the change in optical detection signal is recorded and displayed in mV.

The duration of the Recovery Phase in both modes is dependant upon the time taken to reach the trip point or temperature and the duration between measurements. Typically, for factory-default 10 minute cycle time, the measurement cooling duration is 2 to 3 minutes with the remaining 8 to 7 minutes Recovery Phase. If the system does not reach the trip point or temperature, then the system will re-enter the Recovery Phase after the maximum cooling time has expired.

### 3.3.1 Water Dew-Point Measurement

If a water dew-point sensor is fitted, the instrument will detect its presence at switch-on and display both water and hydrocarbon dew point and pressures as shown in Section 3.12. The water dew point and water dew-point pressure readings are updated at 1 second intervals.

### 3.3.2 Signal Changes and Trip Point

The measurement circuits within the instrument are very sensitive and are capable of sensing  $\mu\text{V}$  changes in the optical detection circuit. When condensate forms on the optical surface of the sensor, the received light level progressively falls and is seen on the status page as an increase in signal change. This is defined as sensor optical surface wet-out. The smallest detectable signal changes can be regarded as the inception of condensate formation. However, for mixed hydrocarbon gas streams where a tail of heavy components is present, this initial change is of little significance since the amounts of condensate are minute and are often undetectable by sensitive chemical analysis methods such as gas chromatography.

The magnitude of the change in the optical detection circuit is a function of the quantity of condensate formed on the sensor surface. Therefore, a signal change threshold can be set which corresponds to some significant condensate quantity; this threshold level is referred to as the 'trip point'. A 'trip point' value can be selected to produce a measured dew-point temperature which agrees with the value predicted by the extrapolation of the linear regression plot of liquid/gas ratio (LGR as a function of temperature) to zero condensate for the gas stream under test.

As the detection principle of the Condumax II is essentially quantitative it can itself be utilized to produce a graphical representation akin to the LGR relationship that can then be used to judge the 'trip point' required for the specific gas under test. Refer to Section 3.3.3 on sensitivity calibration.

In applications at monitoring points where a specific analysis method is stipulated in a contractual specification, e.g. a manual visual optical dew-point measurement instrument, then an alternative method is to select a 'trip point' value that corresponds to the maximum dew-point found by repeated and careful measurement using the stipulated method. In practice, the factory default setting for the 'trip point' of 275 mV for analysis pressure at 27 barg should prove satisfactory if no detailed calibration is available and will return a measured dew-point 0.5...1 °C above the value obtained from manual visual optical techniques applied by an experienced operator observing best practices (ASTM, D1142). An analysis adjustment to 27 barg is the most common measurement practice when monitoring transmission quality gas, in order to determine HC dew-point at the cricondenthem condition (highest temperature at which a two-phase equilibrium will exist on the phase envelope). Analysis at an alternative pressure may require adjustment of the trip point to a revised setting, in order to maintain a consistent sensitivity of analysis. If an alternative analysis is stipulated in the measurement practices or contractual gas quality specifications relevant to a specific application for Condumax II, please contact Michell Instruments for advice.

The processes and signal changes that occur during the formation of condensate on the sensor surface can be monitored using Modbus RTU digital communications via PC software. Contact Michell Instruments (see [www.michell.com](http://www.michell.com)) for more information.

Care should be taken if checking the span of the signal change when using a rich binary test gas, as a very rapid change in the signal will result in an optical surface wet-out.

### 3.3.3 Sensitivity Calibration

When a sensitivity calibration is initiated (Section 3.11), the system will check to ensure the optical surface temperature is within 1 °C of the optical surface temperature set-point and the signal is 0.00%. Once these conditions are met, the system will decrease the optical surface temperature at a controlled ramp rate until the signal has reached 100% of range (1500 mV), or after 10 minutes if 100% cannot be reached.

In order for the system to compute the required optical surface temperature ramp rate, it cools the optical surface down to the Sensitivity Calibration Temperature that is computed from the last hydrocarbon dew-point measurement. This can be changed for diagnostic purposes by the user interface controls.

Once the sensitivity calibration is complete, a table of signal sensitivity vs. temperature is displayed by the instrument or can be downloaded by the Modbus communications to be plotted on a graph.

From the graph below, the signal trip point can be determined by cross-referencing the known dew point of the gas to a sensitivity value. This sensitivity point should then be entered into the instrument as the signal trip point, so that, during the Measurement Phase, the instrument will record the temperature of the optical surface (HCdp) when the signal reaches the signal trip point.

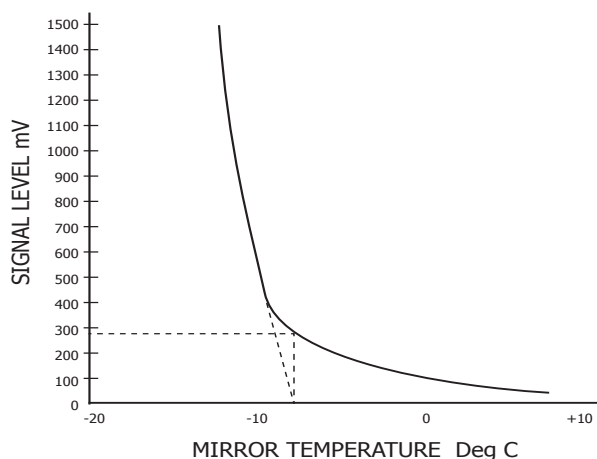

**Figure 8** *Sensitivity Calibration Plot (Example)*

As shown above, the least squares regression of this plot can be utilized to set the Trip Point. i.e. instrument measurement sensitivity. In the case shown a trip level of 275 mV would be determined.

**3.3.4 Adjustment of Measurement Sensitivity to User Defined Reference**

Condensate mode (see Section 3.3) is a useful feature if the customer decides to ‘fine tune’ the Trip point to achieve a harmonized reading with a secondary measurement device (such as Bureau of Mines dew-point apparatus applying ASTM D1142 method).

Secondary measurement device reads x HC dew point at pressure y (which must be the analysis pressure required on the Condumax II). Set Condumax II to analysis pressure y, and operate in Condensate Mode with Trip Temperature set to x, the value measured by the secondary measurement device. Allow the Condumax II to perform at least 3 measurement cycles to assure measurement stability with constant sample gas composition and optimum measurement cooling rate, <0.1 °C/sec (observed in the Status Page). Implement the harmonization of measurement sensitivity adjustment by returning the Condumax II to normal Measurement Mode and setting the Trip Point to the signal change mV value obtained in Condensate Mode.

The facility to adjust the Trip Point setting allows the user to harmonize on-line process measurement sensitivity of the Condumax II with customer’s preferred reference method or to achieve conformance with any relevant regulatory standards that may apply, most typically:

1. Bureau of Mines chilled-mirror dew point apparatus applying ASTM D1142.
2. Potential Hydrocarbon Liquid Content analysis (PHLC) applying ISO6570.
3. Measurements of synthesized natural gas mixture of certified composition with prediction of HC dew-point temperature from equation of state calculation.

3.4 User Interface

3.4.1 Interface Controls

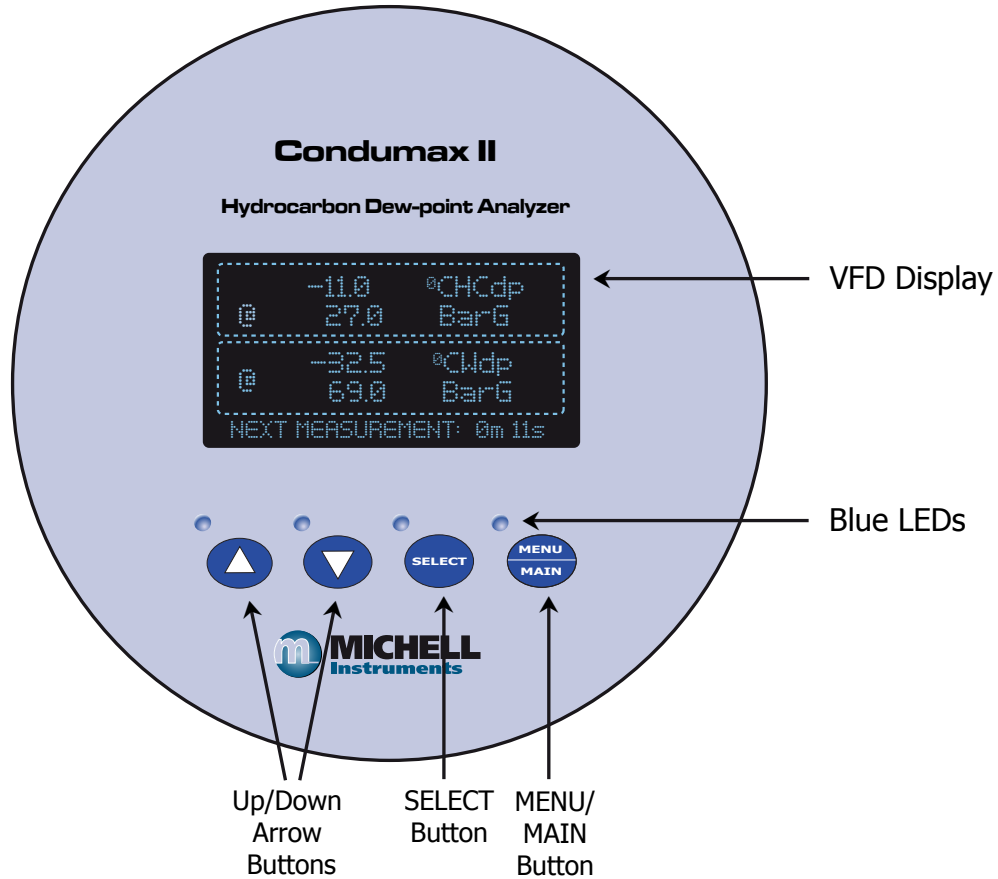

Figure 9 User Interface

The diagram above illustrates the user interface, which consists of a vacuum fluorescent display and four touch sensitive pads that facilitate user interaction through the glass of the enclosure.

3.4.2 'Up/Down Arrow' Buttons

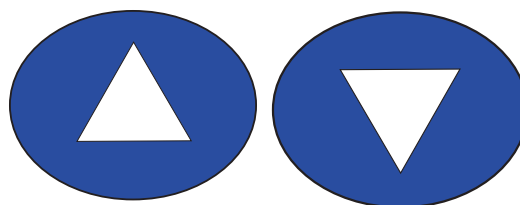

Figure 10 'UP/DOWN ARROW' Buttons

The Up (▲) and Down (▼) buttons are used to change pages, scroll through lists and adjust values.

### 3.4.3 'SELECT' Button



**Figure 11** 'SELECT' Button

The **SELECT** button is used to select or de-select a highlighted item in a menu list.

### 3.4.4 'MENU/MAIN' Button

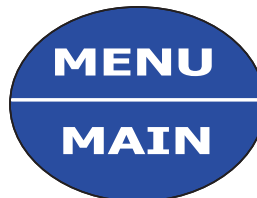

**Figure 12** 'MENU/MAIN' Button

The **MENU/MAIN** button is used to toggle between the **MAIN** page and the **MENU** page, or return to the **MAIN** page from any location within the menu structure.

### 3.5 Menu Structure

The diagram below shows a map of the menu structure:

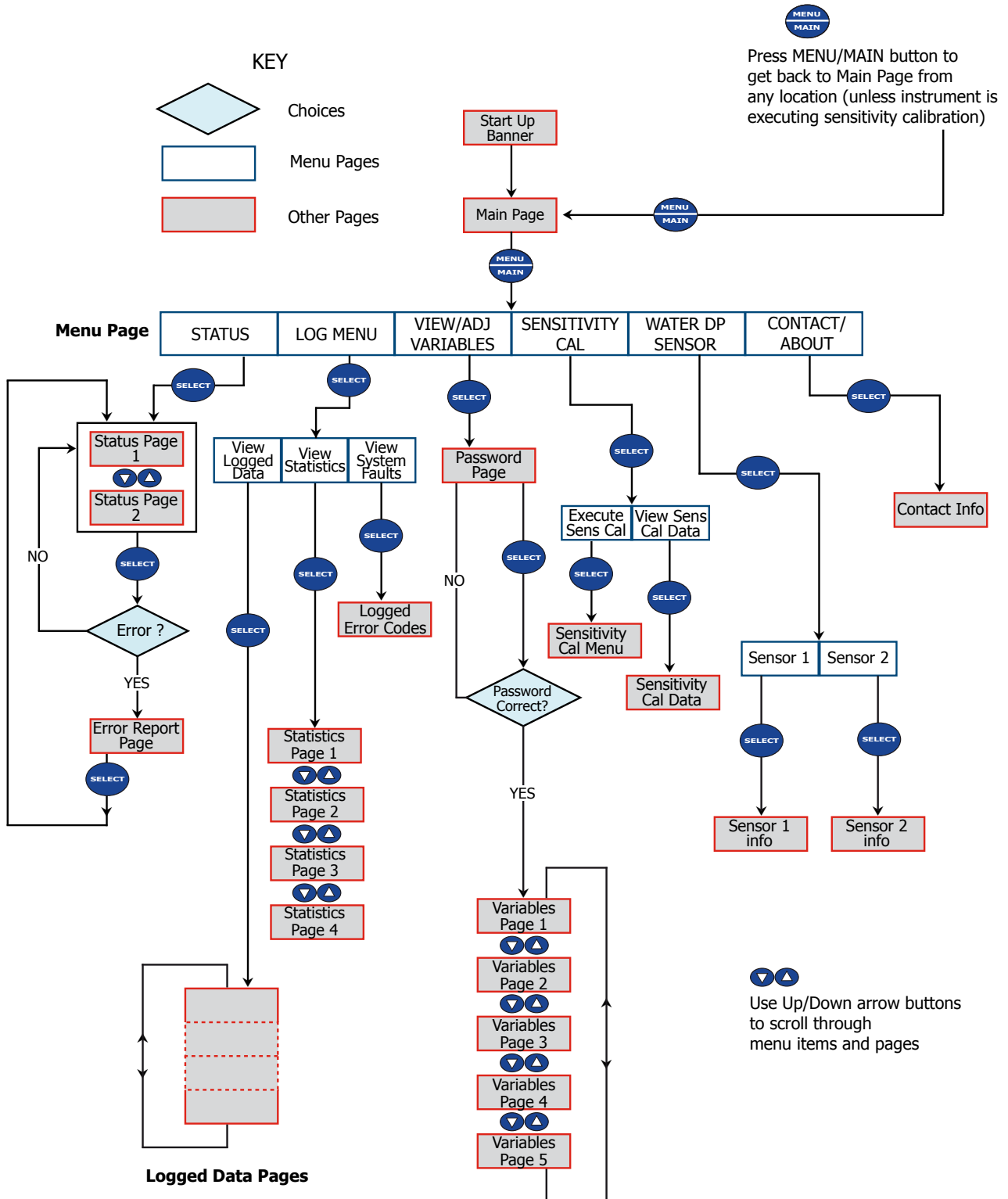

Figure 13 Menu Structure

### 3.6 Main Page

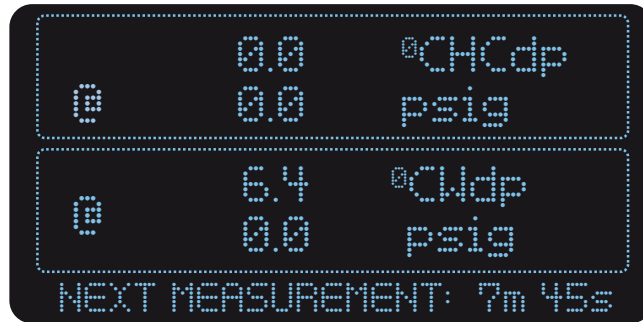

Figure 14 MAIN Page With Wdp Sensor Fitted

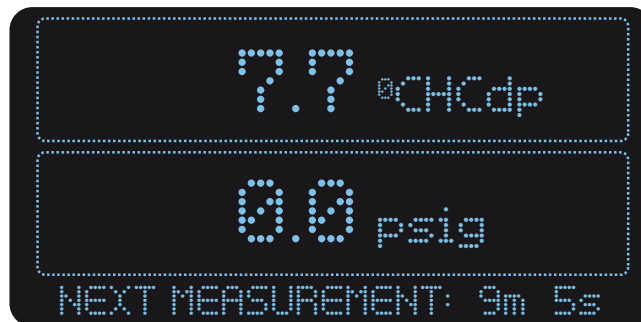

Figure 15 MAIN Page Without Wdp Sensor Fitted

The MAIN page displays the measured parameters and the instrument’s operational status. The information shown is dependent upon whether a water dew-point sensor is fitted or not, as shown above. If a water dew-point sensor is fitted, then dew points for hydrocarbon (°C HCdp) and water (°C Wdp) will be shown along with their associated pressures, otherwise only dew point and pressure for hydrocarbon will be displayed.

The text in the bottom line indicates the time duration until the next Measurement Phase and any system faults that may occur. See Section 4.6 for more information on system faults.

**NOTE: When in condensate mode, the measured value displayed will be the signal level (x10) mV, i.e. 4.0 = 40.0 mV, at the user-set trip temperature.**

### 3.7 Menu Page

Access to the instrument’s status, variables, logged data and system information is available through this page. Use the Up (▲) and Down (▼) buttons to highlight the page of interest and press the SELECT button to access.

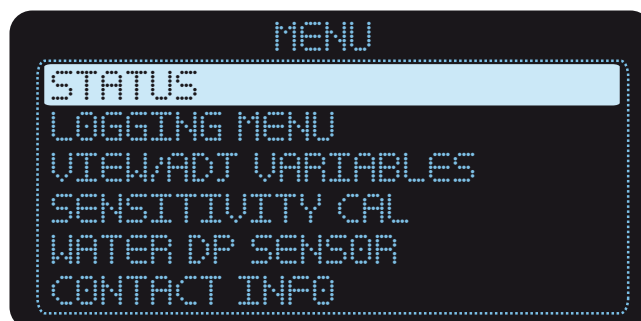
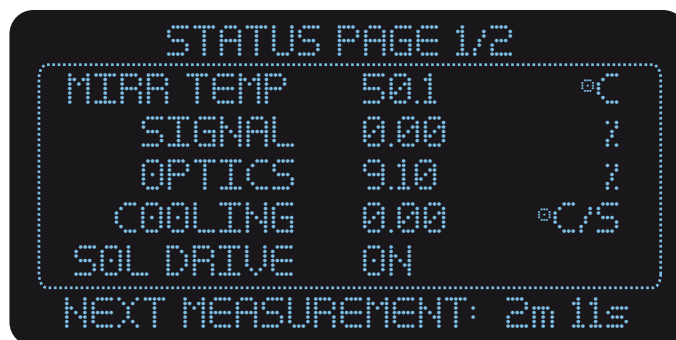

Figure 16 MENU Page

### 3.8 Status Pages

STATUS PAGES 1 and 2 provide status and diagnostic information from the instrument.

#### 3.8.1 Status Page 1



**Figure 17** STATUS Page 1

<b>MIRR TEMP</b>	Display term which refers to the Optical Surface and is an abbreviation for 'mirror temperature'. This is the surface upon which the actual hydrocarbon dew-point measurement is made, and the temperature displayed is the current real-time temperature of the optical surface ( <b>MIRR TEMP</b> ). During the Recovery Phase the optical surface temperature will rise to the set-point temperature and, during a Measurement Phase, the temperature will decrease at a controlled rate until the HCdp is reached. See Appendix D.4 – Heat Temp – for more details.
<b>SIGNAL</b>	Measured signal from the sensor, which is displayed as a percentage of the trip point.
<b>OPTICS</b>	Measure of the condition of the optical surface. Typically a clean optical surface will be indicated by a measurement of between 2 to 10%. If contamination accumulates on the optical surface the % value will increase.
<b>COOLING</b>	Cooling rate of the mirror during the Measurement Phase. It is updated every second during the Measurement Phase, but holds its value when the trip point is reached, until the next Measurement Phase begins.
<b>SOL DRIVE</b>	Drive to solenoid, and is either <b>ON</b> or <b>OFF</b> . During the Measurement Phase the solenoid drive is <b>OFF</b> . During the Recovery Phase the solenoid drive is <b>ON</b> .

3.8.2 Status Page 2

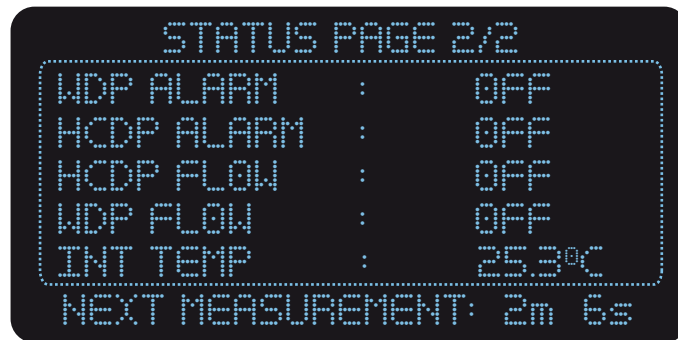

Figure 18 STATUS Page 2

- WDP ALARM**      Water dew-point alarm status, will display either **ON** or **OFF**.

If the water dew point rises above the **WDP** set-point, **ON** will be displayed.

When the water dew-point channel is not fitted the indication will continuously display **OFF**. See Appendix D.3 for more information on setting alarm set point.
- HCDP ALARM**    Hydrocarbon dew-point alarm status, will display either **ON** or **OFF**.

If the hydrocarbon dew point rises above the **HCDP** set-point, **ON** will be displayed. See Appendix D.3 for more information on setting alarm set point.
- HCDP FLOW**     Hydrocarbon dew-point flow switch status – displays **ON** during the Recovery Phase and **OFF** during the Measurement Phase.
- WDP FLOW**      Water dew-point flow switch status, either **ON** or **OFF**.

When the water dew-point channel is not fitted the indication will continuously display **OFF**.
- INT TEMP**      The internal temperature within the instrument.

### 3.9 Logging Menu Page

This page allows the viewing of the logged data or statistical information on the logged data.

#### 3.9.1 Logged Data Page

This page allows access to the previous measurement results made by the instrument. A rolling total of a maximum of 150 samples can be logged, which represents a measurement history of 150 x (measurement time) in minutes. Sample number 1 represents the most recent measurement taken. After 150 measurements have been logged the oldest measurement will be deleted and replaced as each new measurement is logged.

Access to each measurement sample is via the **Up** (▲) and **Down** (▼) buttons, which may be used to scroll through each page of information. If faster scrolling is required (to quickly move to another sample) then this can be accomplished by pressing the **SELECT** button, increasing the sample number by 10. When the sample number selected is greater than that acquired or is greater than 150, Sample 1 will be selected and displayed.

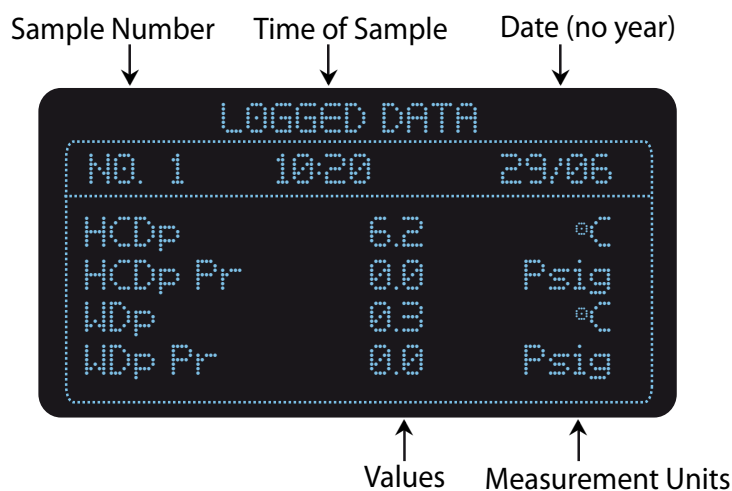

**Figure 19** LOGGED DATA Page

Each page of sampled data contains:

Sample number	(1 to 150; 1 being the most recent)
Date of sample	(dd/mm)
Time of sample	(24 hr format, hh:mm)
The values of	HCDp, Wdp, HCDp Pr and Wdp Pr
The units of measurement	

### 3.9.2 Statistics

These pages display the maximum, minimum and average values for each measured parameter for up to 150 previous measurement samples. **RESET LOG** re-sets the logging statistics.

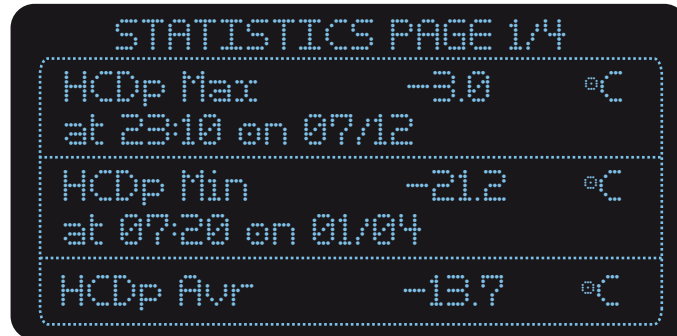
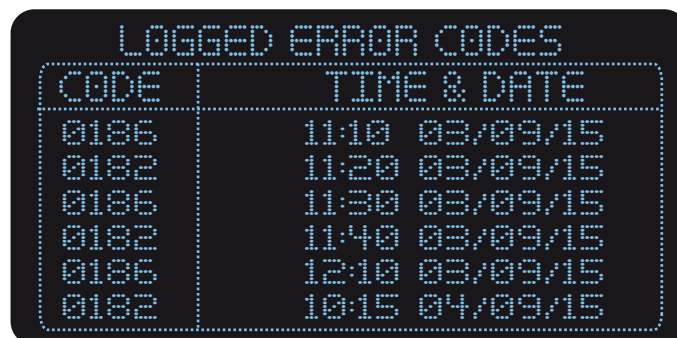

**Figure 20** STATISTICS Page

Use the **Up** (▲) and **Down** (▼) buttons to scroll through the statistics.

### 3.9.3 Viewing Historical System Faults

This page displays a record of the last six system faults that have occurred and have subsequently been corrected, in order to assist in the diagnosis of any past anomaly in measured values. Any present system faults will be displayed in the bottom message line of the **MAIN** page.



**Figure 21** Logged Error Codes

Refer to Section 4.6 for information about the **Error** codes.

### 3.10 Adjusting and Viewing System Variables

#### 3.10.1 Enter Password

To safeguard against unauthorized adjustment of set-up parameters and variables, an entry lock is provided.

The user must first input the access code to enter the **VIEW/ADJUST VARIABLES** area.

The password is a 4-digit number: **7316**

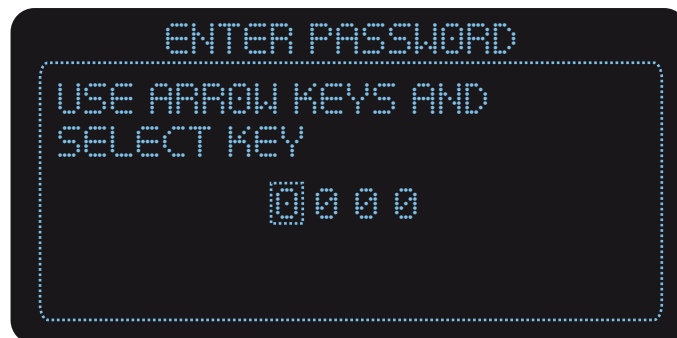

**Figure 22** Password Page

Use the **Up** (▲) and **Down** (▼) buttons to change the highlighted digit and press the **SELECT** button to enter and move to the next digit. Inputting 4 correct digits will result in access to the Variable Pages as detailed in the following sections.

#### 3.10.2 Variable Pages

Five pages are used to display the system variables. They can be adjusted by using the **Up** (▲) and **Down** (▼) and **SELECT** buttons.

Use the **Up** (▲) and **Down** (▼) buttons to scroll up and down the list and from page to page. To select a variable for adjustment, scroll to the desired variable and press the **SELECT** button. A small box will appear beside the value to indicate that it can be adjusted. Use the **Up** (▲) and **Down** (▼) buttons to change the value. **NOTE: Numerical values can be changed at a faster rate by extending the duration of the Up (▲) and Down (▼) button press.**

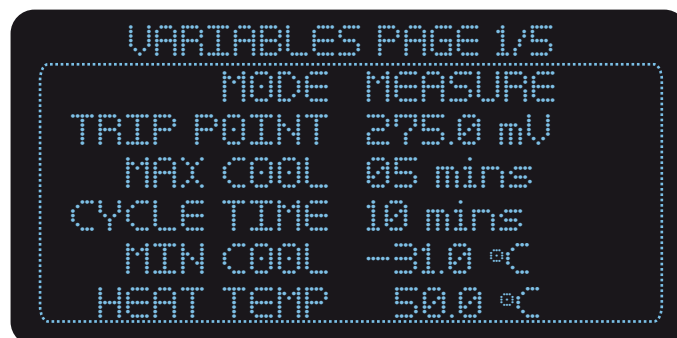

**Figure 23** Variables Page  
(may vary in appearance)

**3.10.3 Variables Page 1**

For more information on each variable refer to Appendix D.1.

Variable	Brief Description
<b>MODE</b>	Instrument mode, <b>CONDENSATE</b> or <b>MEASURE</b>
<b>TRIP POINT</b>	Hydrocarbon Condensation Trip Point (only available in <b>MEASURE</b> mode)
<b>TRIP TEMP</b>	Optical Surface Trip Temperature (only available in <b>CONDENSATE</b> mode)
<b>MAX COOL</b>	Maximum Cooling Time
<b>CYCLE TIME</b>	Frequency of Measurement Cycles
<b>MIN COOL</b>	Minimum Cooling Limit
<b>RESET LOG</b>	Resets the Logging Statistics

**3.10.4 Variables Page 2**

This page contains the variables to configure the mA output ranges. For more information on each variable refer to Appendix D.2.

Variable	Brief Description
<b>OUTPUT1</b>	mA1 Output configuration
<b>O/P 1 MIN</b>	Value that 4 mA represents for Output 1
<b>O/P 1 MAX</b>	Value that 20 mA represents for Output 1
<b>OUTPUT2</b>	mA2 Output configuration
<b>O/P 2 MIN</b>	Value that 4 mA represents for Output 2
<b>O/P 2 MAX</b>	Value that 20 mA represents for Output 2

**3.10.5 Variables Page 3**

For more information on each variable refer to Appendix D.3.

Variable	Brief Description
<b>Wdp ALARM</b>	Water dew-point alarm point
<b>HI DP ALARM</b>	High hydrocarbon dew-point alarm point
<b>DEG C OR F</b>	Units for temperature and dew point
<b>PRESS. UNIT</b>	Units for pressure
<b>TIME</b>	Real time clock
<b>DATE</b>	Calendar

### 3.10.6 Variables Page 4

For more information on each variable refer to Appendix D.4.

Variable	Brief Description
<b>INST ADDR</b>	Instrument network address
<b>THERMO O/S</b>	Thermocouple offset
<b>SET DEFAULT</b>	Resets instrument to default configuration
<b>INT TEMP SP</b>	Internal temperature set-point
<b>HEAT TEMP</b>	Optical surface set-point temperature or differential heating margin, depending on <b>HEAT TYPE</b> – Absolute or Relative – respectively
<b>HEAT TYPE</b>	Optical Surface recovery temperature – Absolute or Relative

### 3.10.7 Variables Page 5

For more information on each variable refer to Appendix D.5.

Variable	Brief Description
<b>HEAT RAMP</b>	Time taken to reach the recovery temperature set-point (recovery phase)
<b>MSK</b>	Factory configuration setting <b>Do not adjust without consultation with Michell Instruments</b>
<b>CELL CONST.</b>	Cell constant Optical compensation factor specific to an individual sensor cell assembly
<b>DIFF COOL</b>	Differential cooling limit: $\Delta T$ internal temperature – mirror temperature (optical surface)
<b>Wdp CHANNEL (optional)</b>	Selects the displayed parameter for the water dew-point channel Dew point or moisture content in natural gas (lb/MMSCF, ppm <sub>v</sub> , mg/m <sup>3</sup> )

### 3.11 Sensitivity Calibration

This is a sub-menu where the user can execute a Sensitivity Calibration procedure or view data measured during the last Sensitivity Calibration procedure.

#### 3.11.1 Executing the Sensitivity Calibration

Selecting EXECUTE SENS CAL displays the Sensitivity Calibration Temperature computed from the last hydrocarbon dew-point measurement. **NOTE: This should generally be left unchanged, however it can be adjusted via the user interface for diagnostic or investigative purposes.**

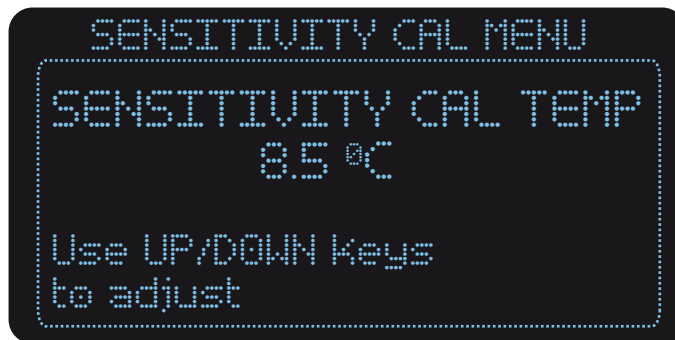

Figure 24 Sensitivity Calibration Page

To select the Sensitivity Calibration Temperature and initiate the Sensitivity Calibration procedure, press the SELECT button. **NOTE: To commence a Sensitivity Calibration, the System Variable Heat Type must be set to ABSOLUTE and the Heat Temperature must be set to +50 °C (+122 °F). See Appendix D.4. This Heat Temperature must be achieved in Recovery Mode (see Section 3.10.6).** This procedure cools the mirror from an elevated temperature and records the mirror temperature against the signal level. While the sensitivity calibration is in process, the results taken are displayed as and when they are sampled. The calibration procedure can be exited at any time by pressing the MENU/MAIN button.

#### 3.11.2 Viewing the Calibration Data

These pages contain the data gathered in the last executed Sensitivity Calibration. There are two pages of data and the user can scroll through the pages using the Up (▲) and Down (▼) buttons.

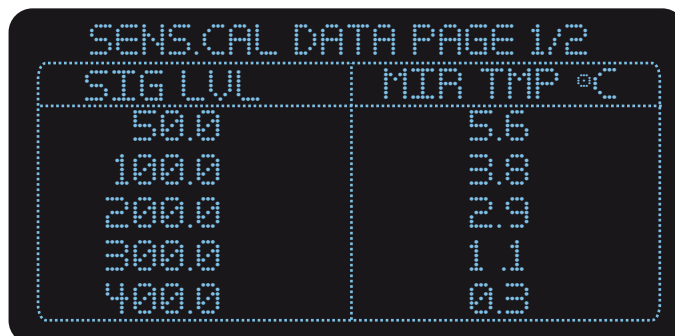
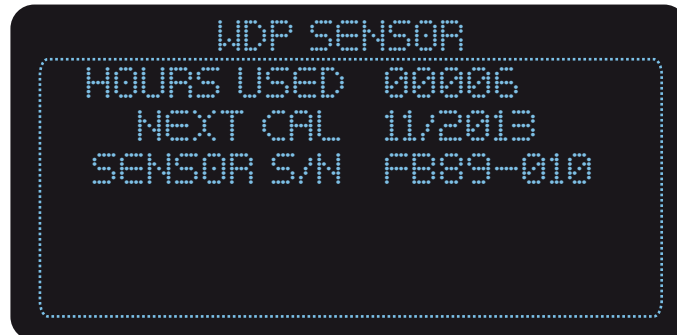

Figure 25 Sensitivity Calibration Data Page

### 3.12 Water Dew-Point Sensor Information

This page contains the information relating to the water dew-point sensor.



**Figure 26** *Water Dew-Point Sensor Information Page*

Hours Used	Duration that the sensor has been in active use
Next Cal	Next recommended calibration date of sensor
Sensor S/N	Serial number of sensor

### 3.13 Contact/About Information

This page contains contact information about Michell Instruments.



**Figure 27** *Contact/About Information Page*

Firmware suffix IGT and ISO signifies the conversion method applied for moisture content in natural gas – either IGT Technical Bulletin No. 8 or ISO18453 respectively.

## 4 MAINTENANCE



**The power to the enclosure must be turned off before any work is carried out in the measurement system enclosure. Observe de-energize durations.**

**Gas line connections to the measurement system must be isolated and de-pressurized before any work commences.**



**Before powering up the instrument the 'Start up purge procedure' must be carried out. See Section 2.6.**

**Any loose or disturbed pipework or couplings must be leak tested.**

The design of the Condumax II sensor cell and measurement system is such that no specific routine maintenance is required. However, if a fault does occur with the system that is not covered within this manual please contact Michell Instruments (see contact information at [www.michell.com](http://www.michell.com)) or your local representative.

### 4.1 Calibration

In order to maintain the calibration to factory standards, Michell Instruments recommends that the hydrocarbon dew-point sensor cell assembly is replaced after every 24 months service, in order to refresh the analyzer's certified calibration and as an effective preventative maintenance routine. (All critical measurement and operation devices are contained within the analyzer cell assembly: light source, detector, peltier heat-pump, optical surface and temperature sensor). A spare cell can be ordered to be held in the site stores. The replaced cell assembly can then be returned to Michell Instruments for full refurbishment, test, calibration and re-certification, to replenish the user's spares stock. For more information refer to Section 1.2.4.

Michell Instruments recommends that the water dew-point sensor should be returned for calibration on a 12 monthly basis to ensure optimum operation. Michell Instruments offers a calibration exchange program, where a replacement sensor can be supplied as an operational replacement and the original item returned to Michell to complete the exchange. Replacement sensors are fully inter-changeable, 'plug and play', with calibration characterization data held in on-board non-volatile memory such that no user programming or configuration setting is required at time of replacement.

**NOTE: The water dew-point sensor calibration intervals may need to be reduced if the operation of the sensor is within potentially aggressive or corrosive sample media (such as sour natural gas). The interval may therefore need to be shortened to 6 months (or lower in extreme cases) in order to maintain satisfactory analyzer performance.**



**All of the procedures below can only be carried out by first unscrewing the enclosure glass cover and removing the user interface assembly.**

## 4.2 Enclosure Cover and User Interface

The enclosure cover is part of the flameproof protection for the enclosure and has IP66/NEMA 4 rating. It should be firmly closed to ensure flameproof integrity and continued environmental protection. For prolonged and easy operation ensure that the threads are always lubricated with a light grease. A grub screw is used as a locking device. This should be loosened before unscrewing the cover counter-clockwise.

The user interface assembly uses two ¼ turn bayonet style fasteners to secure it. These are finger operated and should be turned clockwise to lock and counter-clockwise to release. The user interface, once disconnected from the two ¼ turn fasteners, can be temporarily re-positioned on the instrument by securing the right-hand fastener in the left-hand mount. This will situate the interface assembly in an overhanging position outside of the enclosure allowing greater access. If there is insufficient space to accommodate the overhanging user interface assembly on the left-hand side, it may be rotated 180° (upside down) and placed on the right-hand side.

Always keep the bayonet fittings lightly lubricated. If required, the user interface can be fully disconnected from the instrument by disconnecting the ribbon cable connection to the main processor PCB.

### 4.3 Inspection/Cleaning of Hydrocarbon Sensor Cell Optical Surface



**The power to the enclosure must be turned off before any work is carried out in the measurement system enclosure. Observe de-energize durations.**

If the sensor cell optical surface is badly contaminated or damaged or if there is uncertainty about its accuracy, then it should be replaced.

To clean the sensor cell follow the instructions below:

1. Isolate the incoming sample gas line by closing the sample inlet isolation valve and allowing the system to depressurize. Isolate the power. **NOTE: Always refer to Appendix G.4 – Special Conditions of Safe Use.**
2. Disconnect the LED and detector connectors from the main processor PCB.
3. Remove the four M6 stainless steel cap head screws at the top of the cell retaining the optical housing and carefully withdraw the optical housing. **Caution: The quartz glass window within the optical housing is now free to slide out – ensure this item is secured during removal. On occasion the quartz glass window sealing O-ring may be adhered to the window.**
4. The optical surface is now viewable and accessible for cleaning through the top of the cell assembly. **CAUTION: No attempt should be made to further disassemble the cell, as this will invalidate any previous calibration.**
5. Clean the surface using very light pressure with a laboratory grade wool cotton bud moistened with a suitable solvent, e.g. laboratory grade acetone (99.9%, HPLC grade) or Dichloromethane [methylene chloride] (99.9%, HPLC grade). **Caution: Cosmetic grade acetone (i.e. nail varnish remover) should not be used as residues may remain on the optical surface which can effect measurement performance.**

Clean, using a gentle circular motion, beginning at the centre of the optical surface and progressing to the outside. Clean repeatedly five or six times using a new area of cloth or cotton bud each time. Leave the optical surface open to the atmosphere for 5 minutes after cleaning.

6. Ensure that any particulate matter from the use of the cloth or cotton bud is removed.
7. Clean the quartz glass window with a clean dry cloth, taking care not to scratch it.
8. Re-assemble the sensor cell optical housing in the reverse order. Ensure that the quartz window O-ring is correctly seated and that the M6 screws are fully tightened.

9. To ensure the full requirement of this product's safety certificate is maintained, a gas pressure test and appropriate leak check at 1.5x the max operating pressure must be carried out before the full product is re-energized.



**If gross liquid contamination of the system occurs, contact Michell Instruments for further advice.**

**If minor liquid contamination of the system occurs, purging the system with an inert cylinder gas may prove an effective cleaning method without the need for disassembly of the system.**

#### **4.4 Replacement of the Hydrocarbon Sensor Cell Assembly**



**The power to the enclosure must be turned off before any work is carried out in the measurement system enclosure. Observe de-energize durations.**

To replace the sensor cell assembly, follow the instructions below:

1. Isolate the incoming sample gas line by closing the sample inlet isolation valve and allow the system to depressurize. Isolate the power.
2. Disconnect all electrical connections to the sensor cell.
3. Disconnect the 1/8" sample in and out tube connections from the sensor cell.
4. Remove the four M6 screws around the base plate of the cell. The heatsink compound underneath the base plate acts as an adhesive. To break this bond and aid removal of the cell re-fit one of the M6 screws into the M6 hole in the front left hand corner of the base plate and tighten. This action will release the base plate from the enclosure. The cell assembly can now be removed from the enclosure.
5. Replacement of the new sensor cell is in the reverse order (remember to remove and re-use the corner screw). Before replacement, a light, even application of thermally conductive paste must be applied to the full underside of the sensor cell base plate. Ensure that no particulate matter has adhered to either the base plate or the mating surface inside the enclosure. Any particulate matter found must be removed before fitting to ensure that correct performance of the sensor cell is achieved. Ensure the four M6 cell retaining screws are fully and evenly tightened.
6. To ensure the full requirement of this product's safety certificate is maintained, a gas pressure test and appropriate leak check at 1.5x the max operating pressure must be carried out before the full product is re-energized.



**The unit will need to run a full sensitivity calibration after replacing the Hydrocarbon Sensor Cell Assembly (refer to Section 3.11).**

7. Adjust Cell Constant to value stipulated on Calibration certificate.

## 4.5 Replacement of the Water Dew-Point Sensor



**The power to the enclosure must be turned off before any work is carried out in the measurement system enclosure. Observe de-energize durations.**

To replace the water dew-point sensor, follow the instructions below:

1. Isolate the incoming sample gas line by closing the sample inlet isolation valve and allow the system to depressurize. Isolate the power and observe the de-energize duration.
2. Disconnect the ribbon cable connectors from the PCB on the water dew-point sensor.
3. While restraining the sensor block with a suitably sized spanner (wrench), loosen and remove the 1/8" water dew-point sensor sample pipe connections.
4. Disconnect the pressure transducer from the connector cable to the main processor PCB.
5. Remove the M3 cap head screw securing the water dew-point sensor assembly to the stay bracket and remove the assembly from the enclosure.
6. Fit the replacement water dew-point sensor assembly to the stay bracket and secure with the M3 cap head screw.
7. Re-fit and fully tighten the 1/8" water dew-point sensor sample pipe connections.
8. Reconnect the ribbon cables and the pressure transducer connection to the main processor PCB.



**To ensure the full requirement of this product's safety certificate is maintained, a gas pressure test and appropriate leak check at 1.5x the max operating pressure must be carried out before the full product is re-energized.**

4.6 Troubleshooting

4.6.1 Error Messages

If a system errors occur, an Error Message will appear at the bottom line of the MAIN page describing the problem. If more than one system error has occurred, the Error Messages associated with those faults will continually scroll in turn.



Figure 28 Error Messages

Error Message	Possible Cause
HCdp below cooling limit	Commonly due to hydrocarbon dew-point temperature being below the user adjustable Lower Cooling Limit or the lowest cooling depression being reached during a measurement cycle. Alternatively this could be due to malfunction of the heat-pump, heat-pump drive or optical components, if indicated in combination with other analyzer status messages to that effect.
Unable to adjust optics	Failure of one of the optical components or electronic fault.
No flow during recovery phase	Shut off valve closed or needle valve adjusted in the sampling system. Solenoid fault.
Flow during Measurement Phase	Solenoid failure.
Rapid pressure drop	Change in the sample gas line pressure.
Thermocouple failure	Device failure, connection or electronic fault.
Heat pump failure	Device or heat-pump drive failure.
Failed to reach recovery temperature	Heat-pump failure or heat-pump drive failure.
HCdp pressure transmitter failure	HCdp flow disconnected or device failure.
Wdp pressure transmitter failure	Wdp flow disconnected or device failure.
Internal temperature fault	Device or electronic fault.
Wdp sensor under range	Sensor tile failure.
Wdp sensor over range	Sensor tile failure.
Wdp temperature sensor fault	Temperature sensing device failure.
No Wdp flow	Shut off valve closed or needle valve adjusted in the sampling system. Solenoid fault.

4.6.2 Logged Error Codes

This page displays a record of the last six system Errors Codes that have occurred in order to assist in the diagnosis of any past anomalies. Errors Codes are only logged at the end of every measurement cycle and indicate a change in status of single or multiple errors. For example, if an Error Code 0004 was logged this would indicate **NO FLOW DURING RECOVERY PHASE**. If an Error Code of 0000 was next logged this would indicate that the error had now cleared, i.e. the status had changed.

At first switch on of the Condumax II nothing will appear in the ERROR CODE column. When an error has occurred, but then cleared so that no outstanding errors exist, 0000 will then be logged continually.

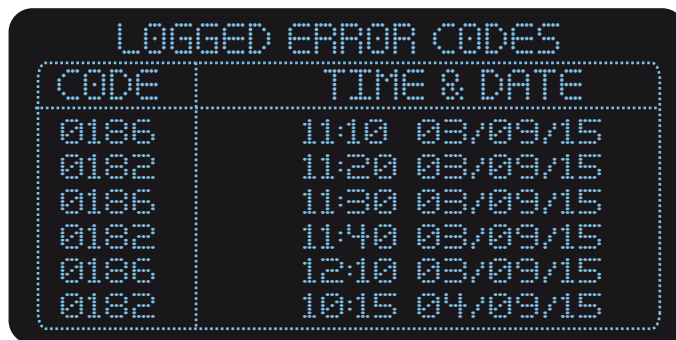

Figure 29 Logged Error Codes

Logged Error Codes and Error Indication (Modbus Register 35). See also Appendix F 'FORMAT C' for more details.

Error Code	Error Message
0000	All previous errors now cleared
0001	HCdp below cooling limit
0002	Unable to adjust optics
0004	No flow during recovery phase
0008	Flow during Measurement Phase
0010	Rapid pressure drop
0020	Thermocouple failure
0040	Heat pump failure
0080	Failed to reach recovery temperature
0100	HCdp pressure transmitter failure
0200	Wdp pressure transmitter failure
0400	Internal temperature fault
0800	Wdp sensor under range
1000	Wdp sensor over range
2000	Wdp temperature sensor fault
4000	No Wdp flow

The 4 digit error codes are a hexadecimal number and are dependent upon the bits set within the error indication register.

If more than one error has occurred, then the Error Codes will be added together.

**Examples:**

- 1 Error Code **0104** =  
Error Code **0100** (HCdp pressure transmitter failure)  
plus  
Error Code **0004** ( No flow during the recovery phase)  
(**0100 + 0004 = 0104**)
  
- 2 Error Code **00C0** =  
Error Code **0080** (Failed to reach recovery temperature)  
plus  
Error Code **0040** (Heat-pump failure)  
(**0080 + 0040 = 00C0**)
  
- 3 Error Code **0182** =  
Error Code **0100** (HCdp pressure transmitter failure)  
plus  
Error Code **0080** (Failed to reach recovery temperature)  
plus  
Error Code **0002** (Unable to adjust Optics)  
(**0100 + 0080 + 0002 = 0182**)

**NOTE: In hexadecimal**

**A = 10**  
**B = 11**  
**C = 12**  
**D = 13**  
**E = 14**  
**F = 15**

### 4.6.3 mA1 Output Analyzer Fault Alarm

The mA1 output has the facility to output an analyzer fault alarm condition of 23 mA when one or more of the error conditions occur, as described in Section 4.6, in order to facilitate a hardware indication of a fault condition.

To activate this alarm when a specific error condition occurs, the corresponding error bit in the Modbus ERROR MASK register (40) has to be set to a '1'. For example, to activate this alarm if the instrument is unable to reach the trip point, then the ERROR MASK register has to be set to 0001. Likewise, if the alarm is to activate when there is a 'HCdp pressure transmitter failure' and/or 'Failed to reach recovery temperature' and/or 'Unable to adjust Optics' error condition as in Example 3 above, then the ERROR MASK register has to be set to 0182.

Refer to Appendix B on Modbus RTU Communications and Appendix F on Number Formats for additional information.

#### 4.6.4 Heat-Pump Depression

There may be circumstances when the performance of the heat-pump or heat-pump drive circuitry may be in question, i.e. when the heat-pump failure error message is observed.

In this situation the heat-pump performance can be easily determined by using the **CONDENSATE** Mode feature of the instrument.

Firstly, set the instrument to **CONDENSATE** Mode and set the trip temperature to -35 °C (-31 °F) and the maximum cool time to 10 minutes. See Section 3.10.3 for more details.

Secondly, after exiting the **MENU** pages, select the **STATUS** page and observe the optical surface temperature during the Measurement Phase. The system will then cool the optical surface down to its absolute maximum until the 10 minute Measurement Phase has expired.

**NOTE: When the system is operating correctly it is capable of cooling the optical surface to approximately -32 °C from an ambient temperature of 21 °C. However, this value will increase at elevated ambient temperatures.**

In the unlikely event that a fault has occurred with the heat-pump or associated circuitry, then no cooling, or a much reduced  $\Delta T$ , from the recovery temperature is symptomatic of these faults.

**4.7 Field verification of HC dew point measurement**

If desired by the user, periodic verification of the HC dew point measurement can be carried out at the field installation location using ethane gas. This gas has a well-defined phase relationship, as shown in the table below.

**Test Gas:**

*Ethane* ≥99.9% purity recommended (99.5% purity is also satisfactory but with increased uncertainty).

A cylinder containing liquified ethane is most convenient for site handling and effective use in delivering the required gas pressure. 1 kg of liquid provides 780 litres of gas supplied at 30...40 barg vapor pressure (assuming moderate ambient temperature). This supply pressure is sufficient to achieve the desired analysis pressure and sample flow for the Condumax II with flow restrictor fitted in accordance with Ex standards current at the time of manufacture of this analyzer.

**Pressure measurement:**

The internal pressure measurement within the HCdp sensor of the Condumax II Analyzer offers an appropriate measurement range and accuracy to carry out this procedure.

**Pressure regulation and sample flow control:**

The Michell Instruments Condumax II sampling system can be operated as normal during the field verification procedure whilst flowing ethane gas in place of process natural gas. The ethane cylinder can be connected directly to the sample gas inlet of the Condumax II sampling system.

**Accuracy expectation:**

The measurement readings of the Condumax II are expected to agree with the theoretical HCdp temperatures shown in the table below, within the following accuracy tolerances:

- +/-0.5 °C when using ≥99.9% purity grade ethane
- +/-1.0 °C when using 99.5% purity grade ethane

<b>Ethane</b>	mol	100	100	100	100	100	100	100
<b>Pressure</b>	Barg	15	16	17	18	19	20	21
<b>Temp</b>	°C	-16.2	-14.0	-11.8	-9.7	-7.7	-5.8	-3.9
<b>Ethane</b>	mol	100	100	100	100	100	100	100
<b>Pressure</b>	Barg	22	23	24	25	26	27	28
<b>Temp</b>	°C	-2.1	-0.4	1.3	3.0	4.6	6.1	7.7
<b>Ethane</b>	mol	100	100	100	100	100	100	100
<b>Pressure</b>	Barg	29	30	31	32	33	34	35
<b>Temp</b>	°C	9.2	10.6	12.0	13.4	14.8	16.1	17.4

**Table of expected HC dew point at the analysis pressure within the Condumax II HCdp sensor cell**

# Appendix A

## Technical Specifications

## Appendix A Technical Specifications

<b>Hydrocarbon Dew-point Sensor</b>	
Measuring Technique	DARK SPOT™ fixed sample analysis. Direct photo-detection of hydrocarbon condensate at hydrocarbon dew-point temperature
Gas Wetted Components	Stainless steel (AISI 316L grade) Viton® O-ring sealed quartz glass window
Optical Surface	Etched stainless steel (AISI 321 grade), conical depression, and embedded miniature precision thermocouple
Sensor Cooling	Automatic via 3-stage Peltier effect electronic cooler under adaptive control
Range	>50 °C range depression from operating temperature of Main Unit at 27 barg (391 psig) sample pressure
Sample Gas Flow Rate	0.5 NI/min (0.03 Nm <sup>3</sup> /hr) (1.1 scfh) alarm standard
Accuracy	± 0.5 °C hydrocarbon dew point
Operating Pressure	15...100 barg (218...1450 psig)
<b>Water Dew-Point Sensor</b>	
Measurement Technique	Michell Ceramic Metal-Oxide Moisture Sensor
Gas Wetted Components	316 stainless steel
Range	Calibrated from -100...+20 °Cdp
Accuracy	±1 °C from -59...+20 °Cdp ±2 °C from -100...-60 °Cdp
Sample Gas Flow Rate	1 NI/min (0.06 Nm <sup>3</sup> /hr) (2.1 scfh) alarm standard
Operating Pressure	30...138 barg (435...2002 psig)
<b>Pressure Measurement</b>	
Range	HCdp 0...100 barg (0...1450 psig) Wdp 0...200 barg (0...2900 psig)
Accuracy	±0.25% FS
Temperature Dependence	1.5% FS / 100 °C (0.83% FS / 100 °F)
Display Resolution	0.1 MPa and barg (1 psig)
<b>Measurement System</b>	
Materials	All gas-wetted parts are stainless steel (AISI 316L grade) with Viton® soft parts
Flow Switch	Stainless steel (AISI 316L grade) Normally open in flow condition
Hydrocarbon Sample Shut Off	12 V DC Solenoid valve, stainless steel (AISI 316L grade) with Viton® soft parts
Enclosure	Aluminum enclosure EExd, Chromate primed and polyester coated black Tested to BS3900 Internally heated for condensation protection
Ingress Protection	IP66 / NEMA 4
Operating Environment	Indoors/Outdoors -20...+50 °C, Max 95%rh
Sample Gas Connections	1/8" NPT(F) female ports for both hydrocarbon and water dew-point channels

Outputs	Modbus RTU RS485 @ 9600 baud rate Two 4...20 mA linear (non-isolated) outputs, user configurable for any combination of dew-point or pressure parameters
Alarms	Process and analyzer status via software register and display annotation Integrated low flow alarms for each sample flow Analyzer status fault flag 23 mA on mA output 1
Cable Entries	3 off pre-machined ISO M20 tapped holes in base of enclosure for cable glands 1 off blank fitted
Power Supply	90...260 V AC, 47/63 Hz (125 W)
Weight	25kg (55lbs) maximum
<b>Hazardous Area Certification</b>	
Certification Codes	See Appendix G

**A.1 Mounting Drawing**

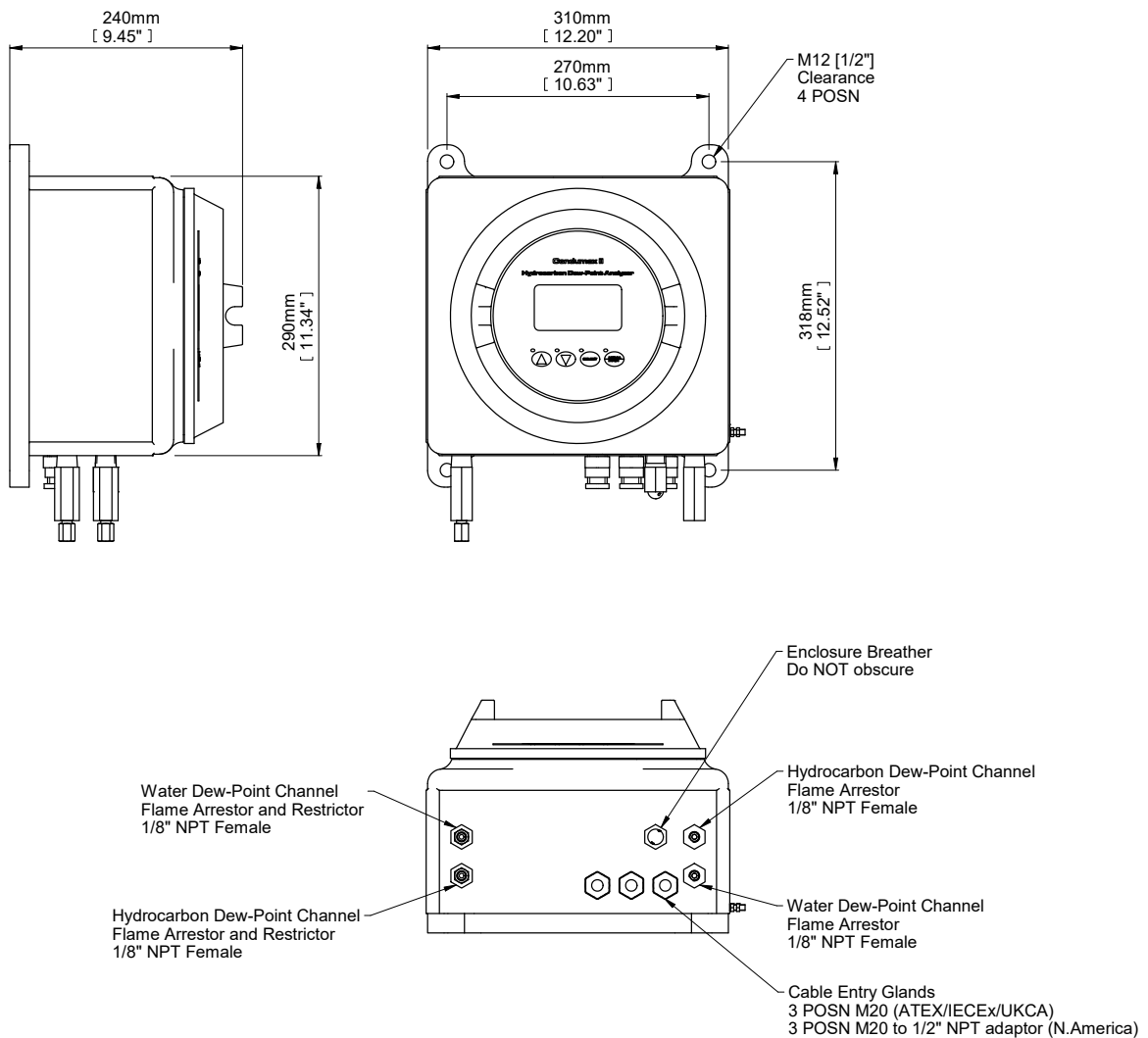

A.2 Flow Diagram

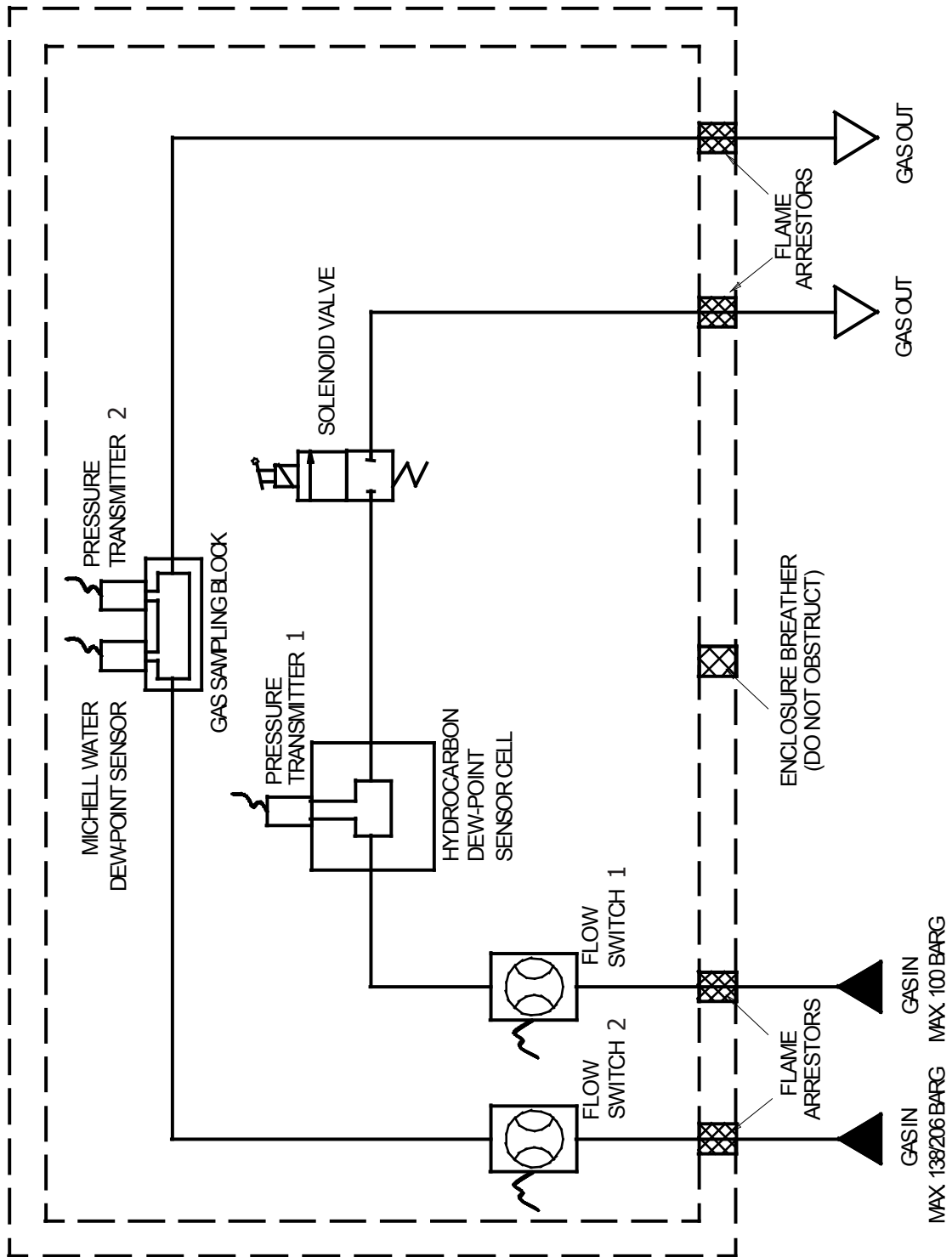

A.3 Wiring Hook-Up Diagram

Terminals are marked:

- L = Live
- N = Neutral
- E = Earth/Ground

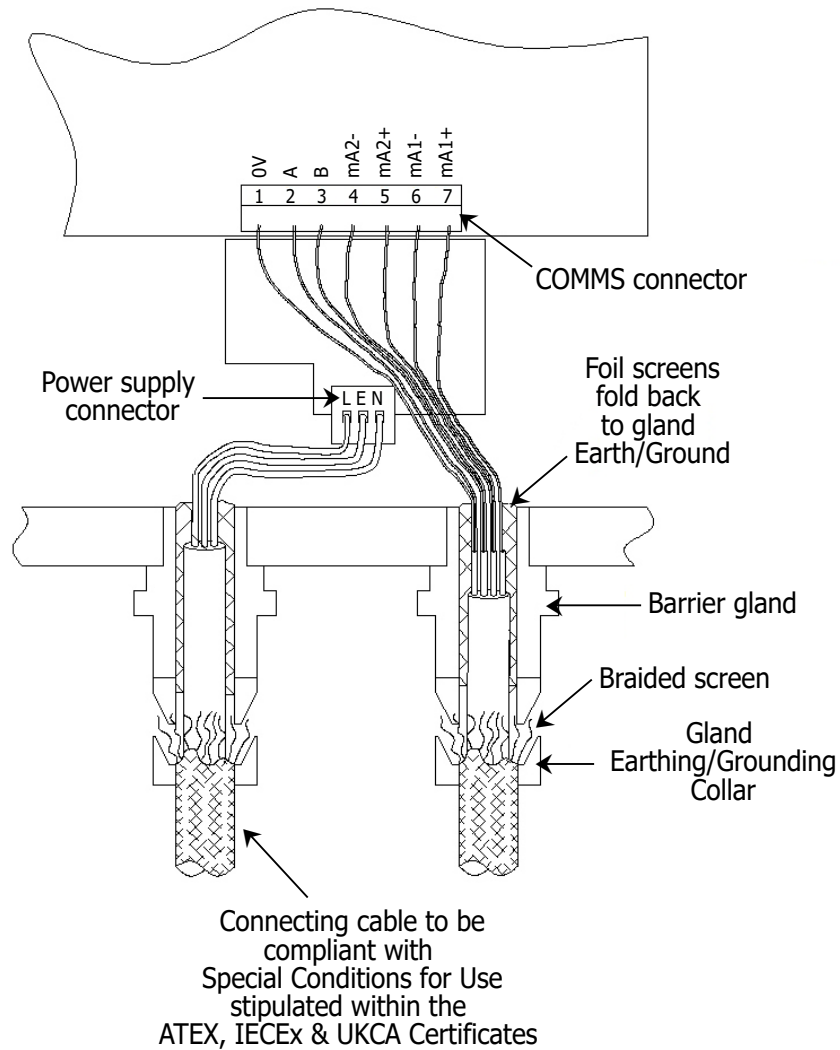

For ATEX/IECEX/UKCA installations: EExd Barrier Glands MUST be used when installing. Refer to the separate Installation & Maintenance Information sheet supplied.

# Appendix B

## Modbus RTU Communications

**Appendix B Modbus RTU Communications**

**B.1 Introduction**

Implemented within the Condumax II are Modbus RTU communications that enable remote access to the instruments' configuration and data logging facilities. This protocol offers two-way communication between a PC or PLC known as the master, to one or more instruments known as slaves. Communication is achieved by the master reading or writing to registers within the slave. The slave will act upon information contained within the registers that can be written, and the master can obtain measured values and status information from the register that can be read. Appendix B.4 lists these registers and Appendix F specifies the number or data formats that apply to each register.

**B.2 Modbus RTU Basics**

Modbus RTU operates on a Query-Response Cycle (see the diagram below), where the function code in the query tells the addressed slave device which actions to perform using the information contained in the data bytes. The error check field provides a method for the slave to validate the integrity of the message contents.

If the slave makes a normal response, the function code in the response is an echo of the function code in the query and the data bytes will contain data collected by the slave, such as register values or status information. If an error occurs, the function code is incremented by 80H to indicate that the response is an error response, known as an exception, and the data bytes contain a code to describe the error. The error check field allows the master to confirm that the message contents are valid.

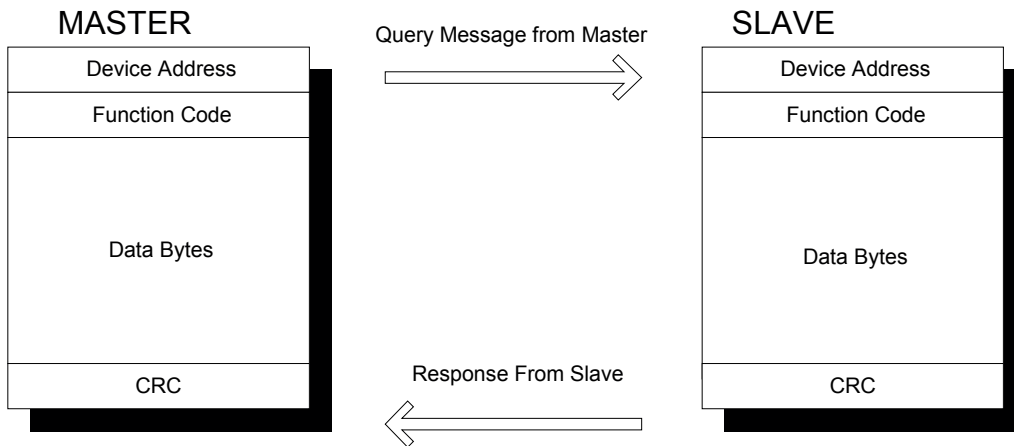

**B.3 Modbus RTU Basics**

The physical connection from the master to the Condumax II uses 2-wire RS485 plus a ground connection, whereby data lines A, B and ground are connected to a communication connector within the instrument. The serial port protocol is as follows:

Baud Rate:	9600
Start Bit:	1
Data bits:	8
Parity:	None
Stop bit:	2

## B.4 Register Map

The following two tables describe the instruments' registers with their address location, Modbus function and the number format. The following table provides more details on the formatting of each parameter in the register map.

### System Parameters

Address dec	Modbus function	Function	Read/Write	Default Value	Register Configuration
0	3/6	Instrument address	R/W	01H	F
1	3	Water dew point	R		A
2	3	Ambient temperature	R		A
3	3	Hydrocarbon dew point	R		A
4	3	Status	R		D
5	3	Signal Level in mV	R		H
6	3	Signal Level as % of Trip Point (0.01%)	R		A
7	3	Phase Time Left mins + secs	R		I
8	3	Cooling Rate 0.01°C/sec	R		A
9	3	Hdp Pressure value	R		H
10	3	Wdp Pressure value	R		H
11	3	Mirror temp	R		A
12	3/6	mA1 output maximum value	R/W	1388H	A; or H if the output is set for a pressure
13	3/6	mA1 output minimum value	R/W	EC78H	
14	3/6	mA2 output maximum value	R/W	1388H	
15	3/6	mA2 output minimum value	R/W	EC78H	
16	3/6	mA output configuration	R/W	100H	B
17	3	Emitter drive as a %	R		A
18	3/6	Max cooling time	R/W	500H	I
19	3/6	Measurement time	R/W	1000H	I
20	3/6	Condensation trip temperature	R/W	F830H	A
21	3/6	Minimum cooling limit	R/W	FC18H	A
22	3/6	High dew-point alarm set point	R/W	0H	A
23	3/6	Wdp dew-point alarm set point	R/W	0H	A
24	3/6	RTC Year(val 1) + Month (val 2)	R/W		I
25	3/6	RTC Date (val 1) + Hours(val 2)	R/W		I
26	3/6	RTC Mins(val 1) + Secs (val 2)	R/W		I
27	3/6	Signal Trip Point in mV	R/W	0113H	F
28	3/6	Set temp when heating	R/W	1388H	A
29	3/6	Units / Command	R/W	0H	E
30	3	Water DP sensor – Batch number	R		I
31	3	Water DP sensor – Serial number	R		I
32	3	Water DP sensor – Year	R		I
33	3	Water DP sensor – Month and day	R		I
34	3	Water DP sensor – Hours of operation	R		F
35	3	Error indicator	R		C
36	3/6	Pressure drop rate as a %	R/W	1388h	A
37	3	Internal temperature	R		A

Address dec	Modbus function	Function	Read/Write	Default Value	Register Configuration
38	3/6	Internal temp set-point	R/W	07D0H	A
39	3	Sensitivity progress 0 to 10	R		F
40		ERROR MASK	R/W	0000H	C
41	3/6	Signal gain	R/W	1000	A
42		Sensitivity cal. temperature	R/W		A
43		Heat time	R/W	5H	I
44		Cool temperature	R/W		A
45	002D	Heat power >= +10	R/W		H
46	002E	Heat power > 0 < +10	R/W		H
47	3	Sensitivity Cal – 10%	R		A
48	3	Sensitivity Cal – 20%	R		A
49	3	Sensitivity Cal – 30%	R		A
50	3	Sensitivity Cal – 40%	R		A
51	3	Sensitivity Cal – 50%	R		A
52	3	Sensitivity Cal – 60%	R		A
53	3	Sensitivity Cal – 70%	R		A
54	3	Sensitivity Cal – 80%	R		A
55	3	Sensitivity Cal – 90%	R		A
56	3	Sensitivity Cal – 100%	R		A
57	3	Instrument type	R	001H	I
58	3	Firmware version number	R		I
59	3	HCdp max	R		A
60	3	Occurred @ day (val 1) + month (val 2)	R		J
61	3	Occurred @ hour (val 1) + min (val 2)	R		J
62	3	HCdp min	R		A
63	3	Occurred @ day (val 1) + month (val 2)	R		J
64	3	Occurred @ hour (val 1) + min (val 2)	R		J
65	3	HCdp average	R		A
66	3	Wdp max	R		A
67	3	Occurred @ day (val 1) + month (val 2)	R		J
68	3	Occurred @ hour (val 1) + min (val 2)	R		J
69	3	Wdp min	R		A
70	3	Occurred @ day (val 1) + month (val 2)	R		J
71	3	Occurred @ hour (val 1) + min (val 2)	R		J
72	3	Wdp average	R		A
73	3	HCdp pressure max	R		H
74	3	Occurred @ day (val 1) + month (val 2)	R		J
75	3	Occurred @ hour (val 1) + min (val 2)	R		J
76	3	HCdp Pressure min	R		H
77	3	Occurred @ day (val 1) + month (val 2)	R		J
78	3	Occurred @ hour (val 1) + min (val 2)	R		J
79	3	HCdp Pressure average	R		H

Address dec	Modbus function	Function	Read/Write	Default Value	Register Configuration
80	3	Wdp pressure max	R		H
81	3	Occurred @ day (val 1) + month (val 2)	R		J
82	3	Occurred @ hour (val 1) + min (val 2)	R		J
83	3	Wdp pressure min	R		H
84	3	Occurred @ day (val 1) + month (val 2)	R		J
85	3	Occurred @ hour (val 1) + min (val 2)	R		J
86	3	Wdp pressure average	R		H
87	0056	Heat power ≤ 0 > -10	R/W		H
88	0057	Heat power ≤ -10	R/W		H
↓	↓	↓	↓	↓	↓
157	00A3	Differential cooling limit	R/W		A
160		Moisture content value for natural gas (Hi Word)	R		L
161		Moisture content value for natural gas (Hi Word)	R		L

Data logging					
256	3	Date Day + Month @ t 0	R		J
257	3	Time Hours + Mins @ t 0	R		J
258	3	Wdp pressure @ t 0	R		H
259	3	HCdp pressure @ t 0	R		H
260	3	Wdp @ t 0 R	R		A
261	3	HCdp @ t 0	R		A
262	3	Date Day + Month @ t-1	R		J
263	3	Time Hours + Mins @ t-1	R		J
264	3	Wdp pressure @ t-1	R		A
265	3	HCdp pressure @ t-1	R		A
266	3	Wdp @ t-1	R		A
267	3	HCdp @ t-1	R		A
↓	↓	↓	↓	↓	↓
1150	3	Date Day + Month @ t – 149			
1151	3	Time Hours + Mins @ t – 149			
1152	3	Wdp pressure @ t – 149			
1153	3	HCdp pressure @ t – 149			
1154	3	Wdp @ t – 149			
1155	3	HCdp @ t – 149			

**NOTE: To download logged data, calculate the start address by the following formulae (sample Number x 6) + 256. Start addresses that do not coincide with the first register of a sample will generate an exception response. Due to the maximum limit of 125 data registers that can be read in one transmission, as defined by the modbus RTU standard, only 20 samples can be downloaded at anyone time. Therefore, eight reads are required to download all 150 samples.**

# Appendix C

## Software

## Appendix C Software

Software is available for the Condumax II to provide full remote control of up to 31 instruments, which has access to all readable and write-able registers as described in Appendix B, along with charting and data logging facilities.

The Condumax II Application Software provides the user with advanced acquisition, logging and charting features for full remote control and monitoring of the Condumax II.

With the Condumax II Application Software it is possible to:

- View all main parameters of interest
- Modify parameters
- Record parameters to a virtual chart recorder
- Record parameters to a file
- Acquire data from up to 31 Condumax II instruments
- Perform remote diagnostics

### C.1 System Requirements

For a desktop computer, the following specifications apply:

- Microsoft Windows 7, 98SE, ME, 2000, XP or 7 operating system
- Spare RS232 port (normally labelled COM1, COM2 etc)
- Minimum of 64 MB of RAM (128M or higher recommended)
- Minimum of 200 MB of free hard disk space (application approximately 3.5 MB spare for log files)
- Intel Pentium II class processor, 200 MHz or higher

Modbus RTU Active-X control software is also available to simplify software development. This software allows plant software engineers to full integrate the Condumax II and Condumax II application software into their plant DCS system.

Contact Michell Instruments for more information (see [www.michell.com](http://www.michell.com) for contact information).

# Appendix D

## Variables Pages

---

## Appendix D Variables Pages

### D.1 Variables Page 1

**Variable: MODE**

Adjustable Range/Options: **MEASURE or CNDSATE (default: MEASURE)**

Description: When **MEASURE** is selected, the instrument is in normal measurement mode. **CNDSATE** is an abbreviation for **CONDENSATE**. In this mode the mirror in the sensor is cooled to the user set **TRIP TEMP** (trip temperature) during each measurement cycle. Therefore the change in signal level during a measurement is related to the quantity of condensate formed on the mirror surface.

**Variable: TRIP POINT** (available only when instrument is in **MEASURE MODE**).

Adjustable Range/Options: **0.00...999mV in 1mV steps (default: 275mV)**

Description: The **TRIP POINT** is an adjustment of the quantity of condensate that must form on the mirror surface to cause the instrument to signal a hydrocarbon dew-point presence. The trip point value is selected by the user to fulfil the requirements of each specific application.

Refer to section 3.3.2 for advice on adjusting **TRIP POINT** appropriate to the user's specifications.

**Variable: TRIP TEMP** (available only when instrument is in **CNDSATE MODE**)

Adjustable Range/Options: **-100...+100 °C (default -10 °C)**

Description: The mirror in the sensor is cooled to the **TRIP TEMP** (trip temperature) during each measurement cycle. The signal change between a clear mirror surface and the condition of the mirror surface up to the **TRIP TEMP** is recorded. The signal change is related to the quantity of condensate formed on the mirror surface.

**Variable: MAX COOL**

Adjustable Range/Options: **2 to 5 minutes in 1-minute steps (default: 4 minutes)**

Description: **MAX COOL** (Maximum Cooling Time) is the maximum duration of cooling during a **MEASURE** or **CONDENSATE** mode cycle. The cooling cycle is aborted if the **TRIP POINT** or **TRIP TEMP** fails to be reached and the analyzer enters Recovery Phase. In such a case, the display and analog output values will remain as per the last successfully completed **MEASURE** or **CONDENSATE** mode cycle. If the maximum cooling time has expired without the mirror surface reaching the **TRIP POINT** or **TRIP TEMP** then this will be flagged as an error. See Section 4.6 for error messages.

**Variable: CYCLE TIME**

Adjustable Range/Options: 10 to 60 minutes in 5-minute steps (default: 10 minutes)

Description: The **CYCLE TIME** is the frequency at which measurement cycles are repeated.

**Variable: MIN COOL**

Adjustable Range/Options: -100...+100 °C (default -35 °C)

Description: **MIN COOL** (Minimum Cooling Limit) should be set to 55 °C lower than the analyzer Main Unit internal operating temperature / 50 °C below the air temperature inside the sampling system enclosure.

**NOTE:** If the **MIN COOL** temperature is reached during a measurement cooling cycle without detection of HCdp (**TRIP POINT** not reached), then the measurement cooling cycle is aborted and the recovery cycle commences. On such occurrences, the analyzer measurement display and outputs for HCdp will update to the temperature achieved during the cooling cycle and the '**HCdp below cooling limit**' message will be displayed at the bottom of the display. In such cases the Condumax II confirms that the HCdp is at an exceptionally low level, lower than the **MIN COOL** setting. Normal measurement of HCdp will recommence automatically at the next cycle when the value rises above the **MIN COOL** setting.

The same measurement cooling cycle abort/automatic resume function applies to other relevant program settings: **MAX COOL** and **DIFF COOL**, triggering '**HCdp below cooling limit**' message.

**Variable: RESET LOG**

Adjustable Range/Options: NONE

Description: Resets the logging statistics so that the variation in measurements can be recorded from a user defined start point.

**D.2 Variables Page 2****Variable: OUTPUT1**

Adjustable Range/Options: HCdp ((x10)mV in condensate mode), Wdp, HCpr, Wpr, Wdp Temp (sample gas temperature), Moisture Content in Natural Gas (dependent upon Wdp CHANNEL selection – refer to Appendix D.5)

Description: Output configuration for mA1. Choose the parameter that corresponds to mA1 output.

**Variable: O/P 1 MIN**

Adjustable Range/Options: -327...+327 °C (default -50 °C)

Description: Zero point of mA1 output. Value of parameter to correspond to minimum output.

**Variable: O/P 1 MAX**

Adjustable Range/Options: -327...+327 °C (default +50 °C)

Description: Full-scale point of mA1 output. Value of parameter to correspond to maximum output.

**Variable: OUTPUT2**

Adjustable Range/Options: HCdp ((x10)mV in condensate mode), Wdp, HCpr, Wpr, Wdp Temp (sample gas temperature), Moisture Content in Natural Gas (dependent upon Wdp CHANNEL selection – refer to Appendix D.5)

Description: Output configuration for mA2. Choose the parameter that corresponds to mA2 output.

**Variable: O/P 2 MIN**

Adjustable Range/Options: -327...+327 °C (default -50 °C)

Description: Zero point of mA2 output. Value of parameter to correspond to minimum output.

**Variable: O/P 2 MAX**

Adjustable Range/Options: -327...+327 °C (default +50 °C)

Description: Full-scale point of mA2 output. Value of parameter to correspond to maximum output.

**D.3 Variables Page 3****Variable: Wdp ALARM**

Adjustable Range/Options: -100...+100 °C (default 0 °C)

Description: Water dew-point alarm point. An error will be flagged on the front panel display **MAIN** page or **STATUS** page if the alarm level is exceeded. See Section 4.6 for error messages.

**Variable: HI DP ALARM**

Adjustable Range/Options: -100...+100 °C (default 0 °C)

Description: High Hydrocarbon dew-point alarm point. This should be set to the process or specification limit of the specific application. An error will be flagged on the front panel display **MAIN** page or **STATUS** page if the alarm level is exceeded. See Section 4.6 for error messages.

**Variable: °C or °F**

Adjustable Range/Options: °C or °F (default °C)

Description: Temperature and dew-point units of measurement, in °C or °F

**NOTE: Changing temperature units will set the default values and clear the logged data.**

**Variable: PRESS. UNIT**

Adjustable Range/Options: psig, barg, MPa (default psig)

Description: Units of measurement for the pressure values – psig, barg or MPa may be selected.

**NOTE: Changing pressure units will clear the logged data.**

**Variable: TIME**

Adjustable Range/Options: hh:mm; 00:00 to 23:59

Description: The real-time clock in 24hr format. Minutes and hours may be adjusted. Pressing either the **Up** (▲) or **Down** (▼) buttons will increment or decrement the minute field and the corresponding hour field will change accordingly and automatically.

**Variable: DATE**

Adjustable Range/Options: Day: 01-31, Month: 01-12, Year: 00-99

Description: The date. Format: ddmmyy. To adjust day, highlight the **DATE** field, and press the **SELECT** button and a 'd' should appear to the right of the year value. Use the **Up** (▲) or **Down** (▼) buttons to adjust the day. To adjust month and year press the **SELECT** button again and a 'm' should appear to the right of the year value. Use the **Up** (▲) or **Down** (▼) buttons to adjust the month. As the month increases or decreases, the year field will change accordingly and automatically. Press the **SELECT** button to finish.

## D.4 Variables Page 4

**Variable:** INST ADDR

Adjustable Range/Options: 0-31

Description: Unique instrument address for networking. This address is used by the MODBUS protocol to specify the location of the Condumax II instrument in the network.

**Variable:** THERMO O/S

Adjustable Range/Options: -10...+10 °C

Description: A value that is used to trim out the tolerance of the thermocouple cold junction compensation circuit – factory setting. **Do Not Adjust.**

**Variable:** SET DEFAULT

Adjustable Range/Options: NONE

Description: Sets instrument to default configuration. All the default values for all the variables and parameters are set.

The default values are:

- |                                  |                  |
|----------------------------------|------------------|
| • Mode                           | Measure          |
| • Signal trip point              | 275 mV           |
| • Max cool time                  | 4 minutes        |
| • Cycle time                     | 10 minutes       |
| • Minimum cooling limit          | -35 °C (-31 °F)  |
| • mA1 o/p                        | HCdp             |
| • mA1 max                        | +50 °C (+122 °F) |
| • mA1 min                        | -50 °C (-58 °F)  |
| • mA2 o/p                        | Wdp              |
| • mA2 max                        | +50 °C (+122 °F) |
| • mA2 min                        | -50 °C (-58 °F)  |
| • Wdp alarm s/p                  | 0 °C (+32 °F)    |
| • HCdp alarm s/p                 | 0 °C (+32 °F)    |
| • Deg C or F                     | °C               |
| • Pressure                       | psig             |
| • Internal temperature set-point | +20 °C (+68 °F)  |
| • Heating temperature            | +50 °C (+122 °F) |
| • Heat type                      | Absolute         |
| • Heat ramp                      | 3 minutes        |
| • Differential cooling limit     | +60 °C (+140 °F) |
| • Water dew-point channel        | Dew point        |

**Variable:** INT TEMP SP

Adjustable Range/Options: 0...+50 °C (default +20 °C)

Description: Sets the set-point for the internal heater.

**Variable:** HEAT TEMP

Adjustable Range/Options: -20...+70 °C (default +50 °C)

Description: During a recovery cycle, the mirror surface temperature will be heated to and maintained at the **HEAT TEMP** (Heat Temperature) until the next measurement. This temperature should be sufficiently high to clear the mirror of any condensate and burn off any other contamination.

**Variable:** HEAT TYPEAdjustable Range/Options: **Absolute or relative (default Absolute)**

Description: During a recovery cycle, the mirror surface temperature will be heated to and maintained at the **HEAT TEMP** (Heat Temperature) until the next measurement. **HEAT TEMP** can either be absolute, or relative to the previously recorded dew point.

**D.5 Variables Page 5****Variable: HEAT RAMP**

Adjustable Range/Options: 1-5 (mins) (default 3 mins)

Description: The ramp time to reach the recovery temperature.

**Variable: MSK**

Adjustable Range/Options: NONE (default 0.0)

Description: Factory configuration setting. **Do not adjust without consultation with Michell Instruments.**

**Variable: CELL CONST.**

Adjustable Range/Options: 2000...5000

Description: Cell constant. The cell constant is specific to a sensor cell and should be re-set at the time of sensor cell replacement to the value stipulated on the Calibration certificate.

**Variable: DIFF COOL**

Adjustable Range/Options:  $\Delta$  50...65 °C (default +60 °C)

Description: Differential cooling limit:  $\Delta T$  internal temperature – mirror temperature (optical surface). This function limits the workload on the Peltier heat pump during exceptionally high temperature operation and/or low dew-point excursions.

**Variable: Wdp CHANNEL**

Adjustable Range/Options: DP, LBMMSCF, PPM<sub>v</sub> NG, mgm<sup>-3</sup> (default DP)

Description: Sets the display option for the Wdp channel: Dew Point (DP) or Moisture Content. Setting one of the moisture units for natural gas (LBMMSCF, PPM<sub>v</sub> NG, mgm<sup>-3</sup>) enables its selection for output mA1 and mA2. The conversion method applied for moisture content is specific to the firmware version installed on the analyzer, either IGT Technical Bulletin No. 8 or ISO18453. Refer to Section 3.13.

# Appendix E

## Modbus RTU Details

## Appendix E Modbus RTU Details

### E.1 Message Framing

START	ADDRESS	FUNCTION CODE	DATA	CRC	END
3.5t	1 byte	1 byte	n x bytes	2 bytes	3.5t

#### Start and End

The message begins and ends with a silent delay of 3.5 character times at the baud rate of the network.

#### Address

The first byte transmitted is the address of the Condumax instrument, which has an address range of 1...247 or 01H...F7H. The master addresses the Condumax by placing an address in the address byte and, if matched by the Condumax own address, it will response to the message, otherwise it will be ignored. See Appendix B on setting the address.

#### Function Code

The function code tells the Condumax which operation is to be performed on the data in the following data bytes. The only valid codes are 03 (Read Holding Registers), or 06 (Write To Single Register) as these are the only two implemented in the Condumax.

An exception can occur if the message contains an unsupported function code, an illegal data address or an illegal data value. If this occurs, the function code is incremented by 80H and the data bytes returned are set to a value that describes the error. See the section on exception responses.

#### Data Bytes

The data bytes within the message from the master contain additional information that the Condumax must use to perform the action defined in the function code, such as the starting register address and the number of registers to be retrieved.

#### CRC

The CRC is a 2 byte error check value from the result of a Cyclical Redundancy Check calculation performed on the message contents. The CRC is appended to the message as the last field in the message, whereby the low-order byte is appended first, followed by the high-order byte.

E.2 Implemented Functions

03 Read Holding Registers

This function code is used to read the contents of a contiguous block of holding registers where the master specifies the starting address and the number of registers to be read. The figure below shows the state diagram of how the message is processed with the exceptions that may be raised.

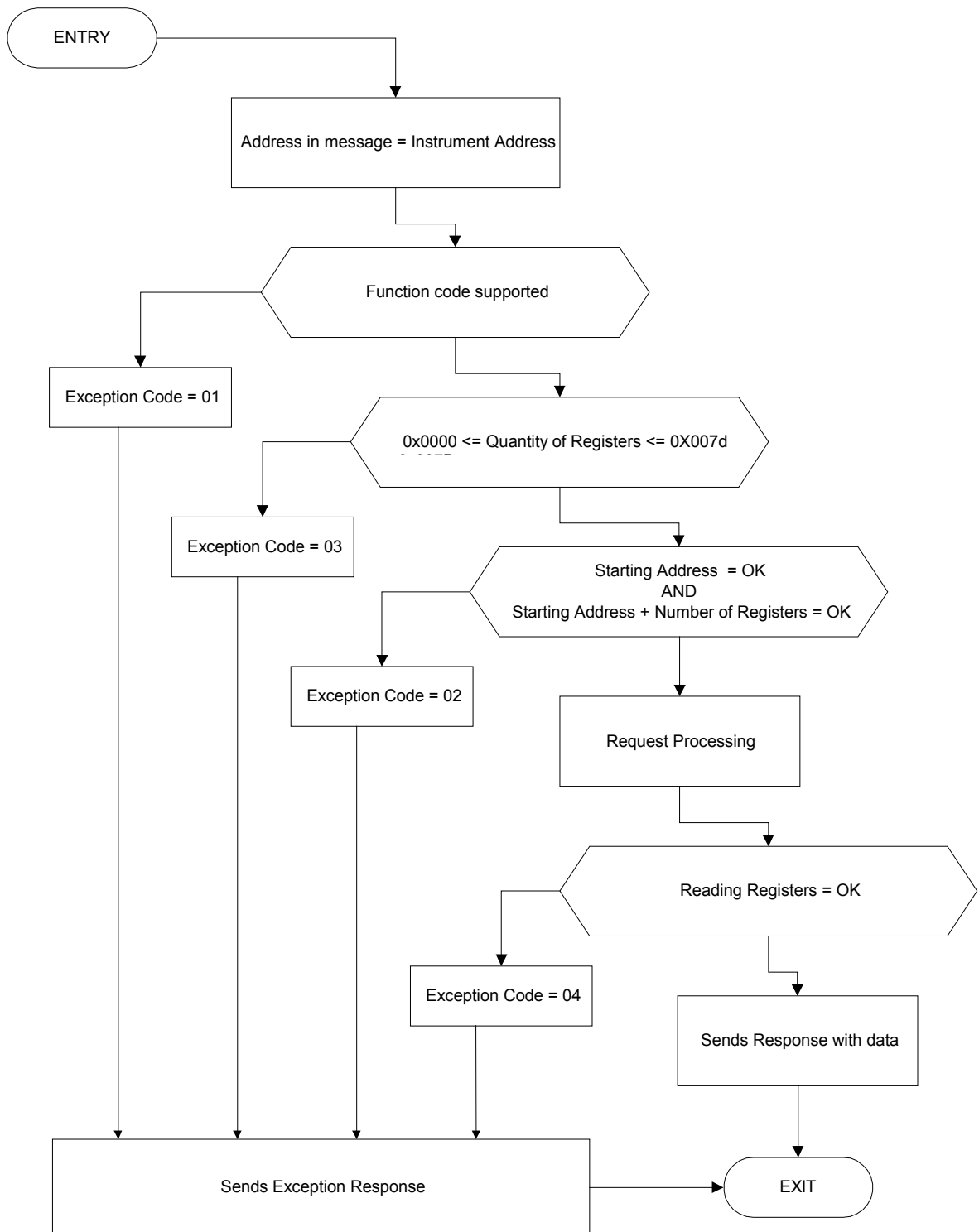

Figure 30 Reading Holding Registers State Diagram

The table below is an example of a message sent by the master, to read the signal level (register 6) and the phase time left (register 7). The message shows a master addressing a Condumax with a slave address of 01H and a Modbus function of 03H, that informs the Condumax that it wishes to read two registers starting from address 06H, where bytes 3 & 4 hold the starting address and bytes 5 & 6 hold the number of registers to be read. Bytes 7 & 8 contain the CRC code that is calculated using bytes 1 to 6 as represented below.

#### Read Request Message

Byte No	Meaning	Value
1	Slave address	01H
2	MODBUS function code	03H
3	Starting address MSB	00H
4	Starting address LSB	06H
5	No of points MSB	00H
6	No of points LSB	02H
7	CRC Lo Byte	??H
8	CRC Hi Byte	??H

In response to the above message, the Condumax will transmit with the following message.

#### Read Response Message

Byte No	Meaning	Value
1	Slave address	01H
2	MODBUS function code	03H
3	Byte count	04H
4	Data MSB	13H
5	Data LSB	97H
6	Data MSB	05H
7	Data LSB	26H
8	CRC Lo Byte	??H
9	CRC Hi Byte	??H

This response repeats the address of the Condumax and the function code, along with the byte count, the data and the CRC. In this example, the request asked for the values from two registers therefore, the number of bytes returned is four, the value of register 6 is contained in bytes 4 & 5 and the value of register 7 in bytes 6 & 7. Register 6 = 50.15% and register 7 = 5m 26s in this example.

Any errors within the data of Read Request Message, will result in an exception being raised.

06 Write to Single Register

This function code is used to write a 16 bit value into a single register, and the master specifies the address and the value to be written. The figure below shows the state diagram of how the message is processed with the exceptions that may be raised.

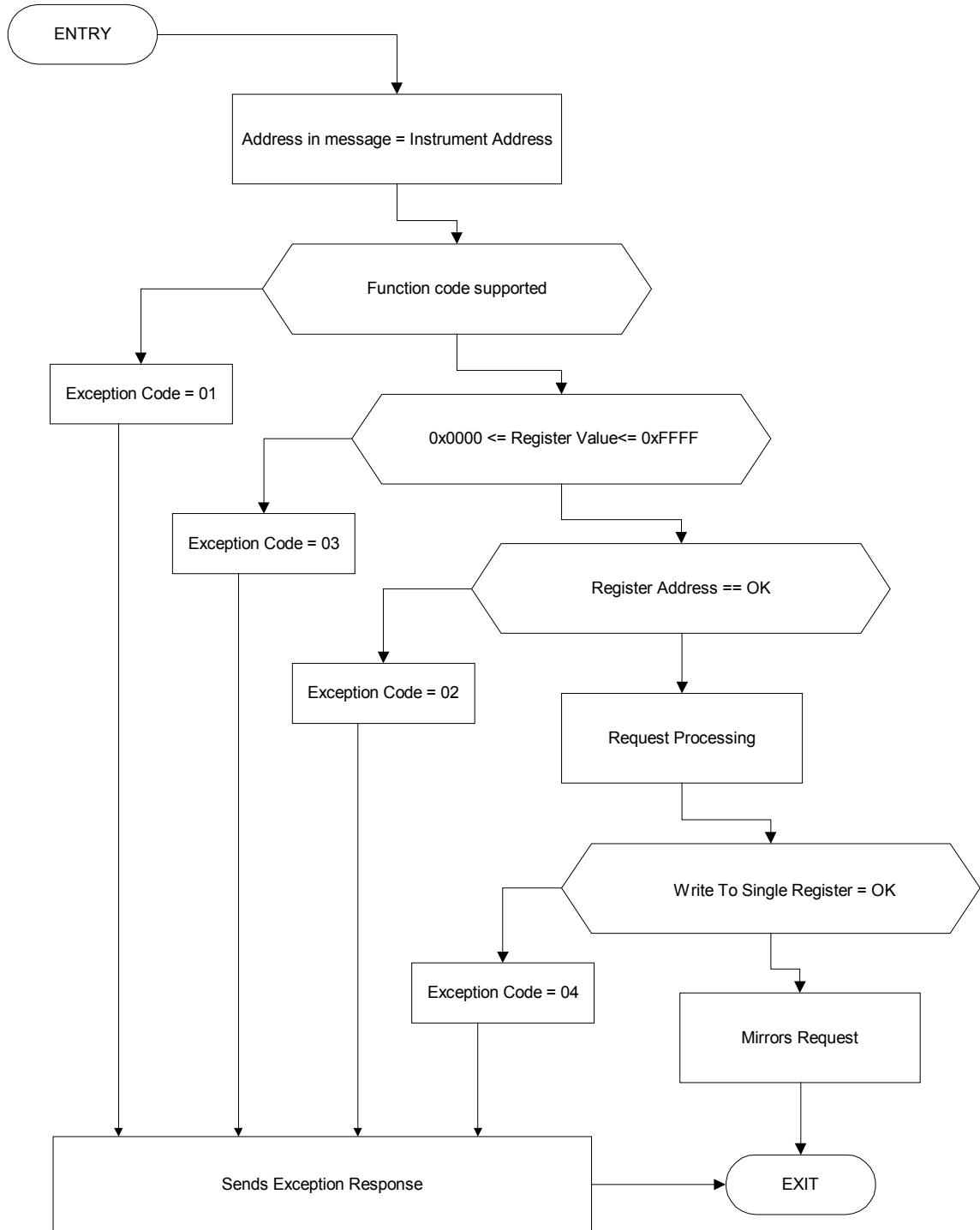

Figure 31 Write Single Register State Diagram

The table below shows the data bytes in a write to register message. Bytes 1 to 4 contain the address of the Condumax, Modbus function, starting register address and the data value to be written. In this example, a master sends FC18H, to address 0015H, to a Condumax with an address of 01H. The CRC is calculated using the data in bytes 1 to 6.

Write Single Register Request and Response

Byte No	Meaning	Value
1	Slave address	01H
2	MODBUS function code	06H
3	Starting address MSB	00H
4	Starting address LSB	15H
5	Data MSB	FCH
6	Data LSB	18H
7	CRC Lo Byte	??H
8	CRC Hi Byte	??H

The normal response from the Condumax is to re-transmit the received message. However, if the data within the message is incorrect, then an exception response will be transmitted.

**E.3 Exceptions**

A message request from the master will raise an exception response from the slave (Condumax) if:

- the function code is unsupported
- the register quantity > 127 (0x007D)
- the register address is invalid
- the register address + the quantity of register is invalid
- an error occurred while performing the function

The exception response will contain the function code incremented by 80H and the exception code.

The table below lists the codes supported along with an explanation of each code:

Code	Name	Meaning
01	ILLEGAL FUNCTION	The function code received in the query is not an allowable action for the slave (Condumax).
02	ILLEGAL DATA ADDRESS	The data address received in the query is not allowable. More specifically, the combination of starting address and number of registers is invalid for the slave.
03	ILLEGAL DATA VALUE	A value contained in the query data field is not an allowable value for the slave.
04	SLAVE DEVICE FAILURE	An unrecoverable error occurred while the slave was attempting to perform the requested action.

Example of an Exception Response that reads a discrete inputs message generating an illegal function exception

Byte	Meaning	Value
1	Slave Address	01H
2	Function	82H
3	Exception Code	01H
4	CRC	??

The example above shows that the function code (02H) sent in the request has been incremented by 80H with the exception code 01H included as the data within the message.

# Appendix F

## Number Formats

Appendix F Number Formats

Format A

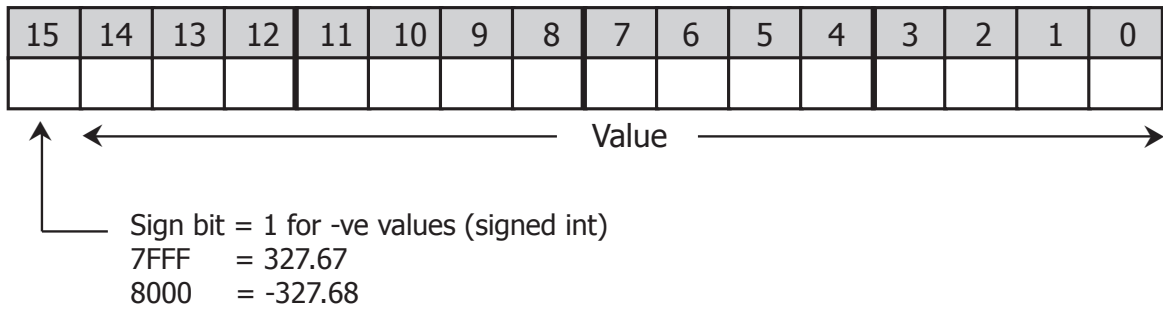

The value in bits (15 to 0) + 1 is divided by 100 to give 0.01 resolution.

In the sole case of MODBUS Register 44, COOL TEMPERATURE, the value in bits (15 to 0) + 1 is divided by 10 to give 0.1 resolution.

Format B mA Output Configuration

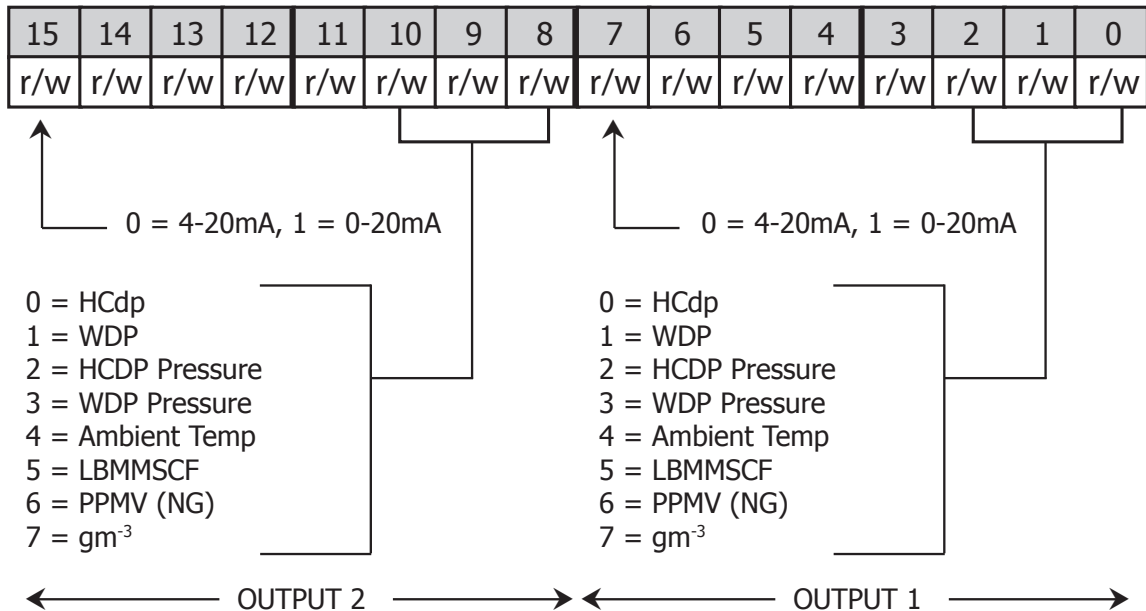

**NOTE:** In condensate mode, HCdp is equal to the signal level in (x10)mV, when the mirror temperature reaches the trip temperature.

**Format C**

15	14	13	12	11	10	9	8	7	6	5	4	3	2	1	0
r	r	r	r	r	r	r	r	r	r	r	r	r	r	r	r

**Error Conditions**

- Bit 0 HCdp below cooling limit, also for sensitivity calibration failure
- Bit 1 Unable to adjust optics
- Bit 2 No flow during recovery phase
- Bit 3 Flow during Measurement Phase
- Bit 4 Rapid pressure drop
- Bit 5 Thermocouple failure and over or under range (> 120 or < -100)
- Bit 6 Heat pump failure
- Bit 7 Failed to reach recovery temperature
- Bit 8 HCdp pressure transmitter failure
- Bit 9 Wdp pressure transmitter failure
- Bit 10 Internal temperature fault
- Bit 11 Wdp sensor under range
- Bit 12 Wdp sensor over range
- Bit 13 Wdp temperature sensor fault
- Bit 14 No Wdp flow

**Format D Status Word**

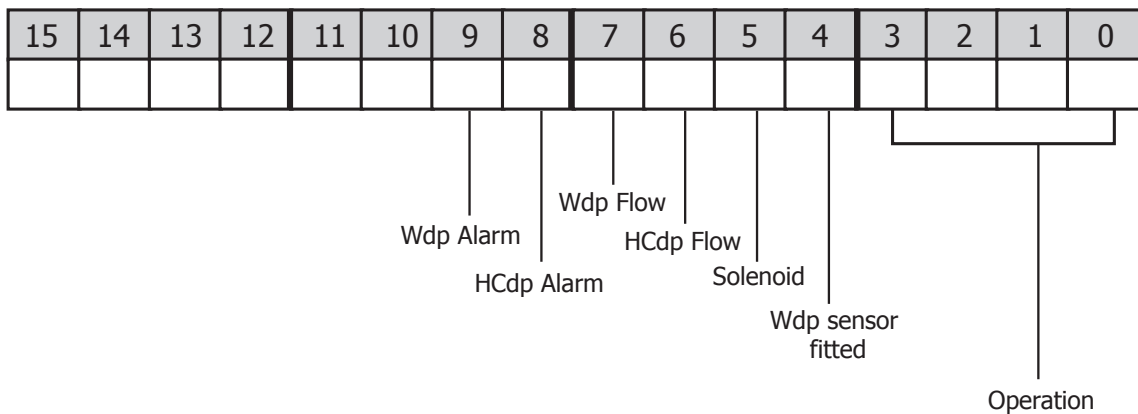

- Status
- XXX0 = Measurement
  - XXX1 = Recovery
  - XXX2 = Initializing
  - XXX4 = Sensitivity Cal

- 1 = ON or Fitted
- 0 = OFF or Not Fitted

**Format E Units Command**

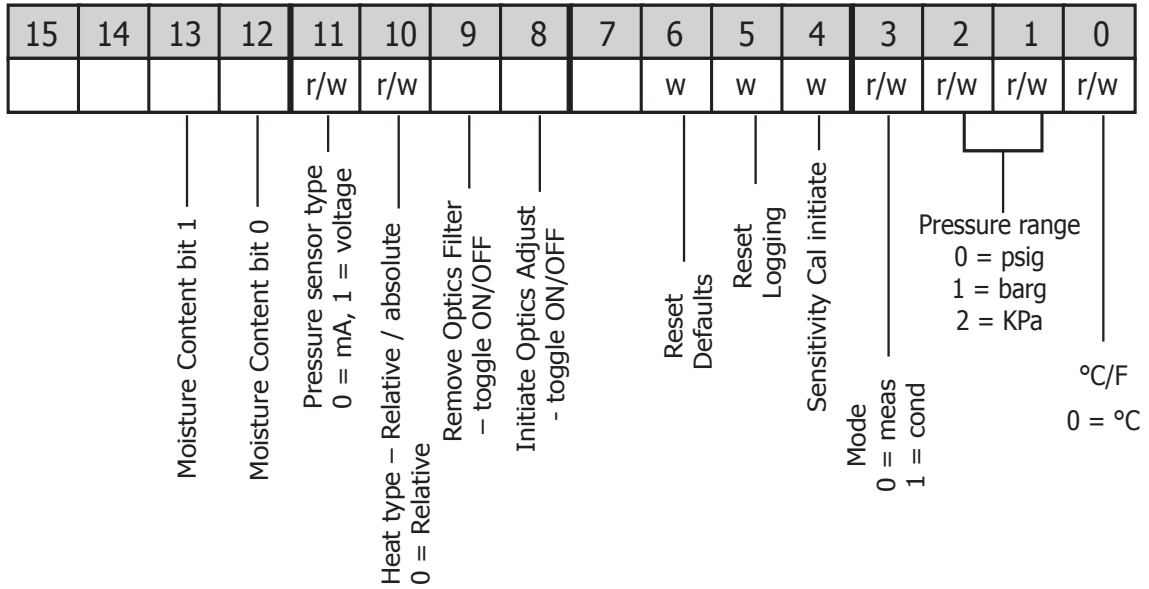

Moisture Content bits 0 & 1: 00 = DP, 01 = LBMMSCF, 10 = PPMV(NG), 11 = mgm<sup>-3</sup> (NG)

'1' = ON / Fitted / Initiate  
'0' = OFF or Not Fitted

The default values are shown in Appendix D.4.

**NOTE: When initiating a command, i.e. the resetting of defaults, logging or a sensitivity calibration, the value of bits 0 to 3 are insignificant and do not need to be set. However, if you are setting units or changing mode, then bits 0 to 3 need to reflect the required set-up of the instrument. i.e. the mode of the instrument cannot be changed without setting the units of pressure or temperature.**

**Format F**

15	14	13	12	11	10	9	8	7	6	5	4	3	2	1	0
r/w	r/w	r/w	r/w	r/w	r/w	r/w	r/w	r/w	r/w	r/w	r/w	r/w	r/w	r/w	r/w

0 to 65535

**Format H**

15	14	13	12	11	10	9	8	7	6	5	4	3	2	1	0

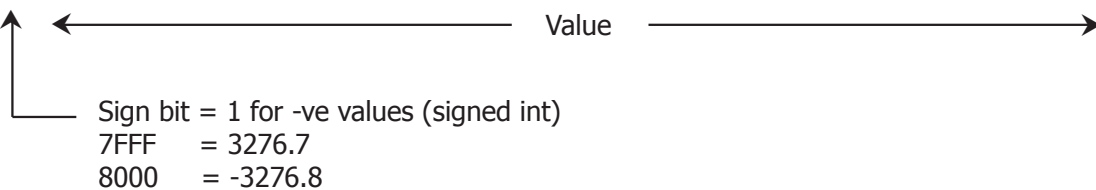

The value in bits (15 to 0) + 1 is divided by 10 to give 0.1 resolution.

**Format I**

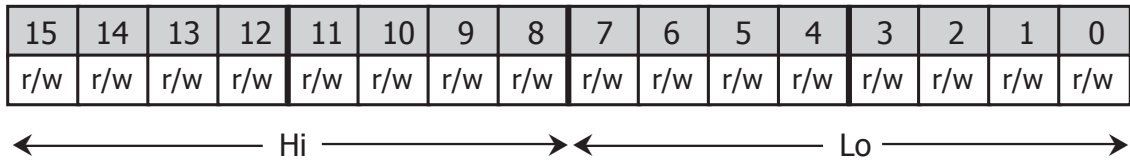

The values for Hi & Lo are in BCD, therefore 10H = 10, 58H = 58 and 09H = 9 etc... Bits 15 to 12 in the Wdp batch number (001D) are allowed to have a value between A to F, otherwise they are invalid.

Values for Cycle Time and Max Cool Time are in units of 5 minutes.

**Format J**

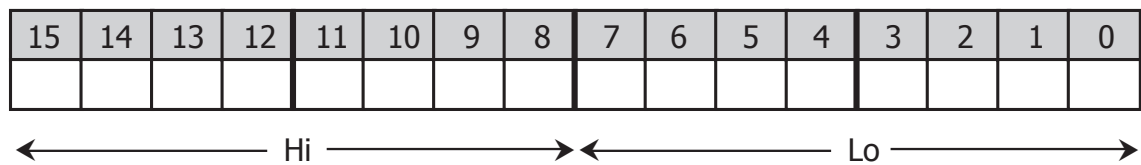

Values in HEX i.e. 17th March = 1103H

**Format L – Floating Point Representation**

The moisture content in natural gas of the water dew point is represented in IEEE-754 single precision floating point format, in order to cater for the wide range in the value of ppm(v). This format is 'Big Ended' which means that the high byte is at a lower address in memory than the Lo byte, and is represented as such in the register memory map. The IEEE-754 format is shown below.

Bit 31	Bits 30 to 23	Bits 22 to 0
Sign bit 0 = + 1 = -	Exponent Field has a +127 bias value	mantissa Decimal representation of binary Where 1.0 <= value < 2.0

Examples of floating point to HEX are shown below.

1) +10.3

sign bit = 0

Exponent = 3, therefore exponent field =  $127 + 3 = 130$ , and bits 30 to 23 = 1000 0010

The mantissa = 1.2875 which in binary representation = 1010 0100 1100 1100 1101

Adjusting the mantissa for the exponent moves the decimal point to the right if positive and to the left if negative.

As the exponent is = 3 then the mantissa becomes = 1010 0100 1100 1100 1100 1101, therefore:

$$1010 = (1 \times 2^3) + (0 \times 2^2) + (1 \times 2^1) + (0 \times 2^0) = 10 \text{ and}$$

$$0100 \ 1100 \ 1100 \ 1100 \ 1101 = (0 \times 2^{-1}) + (1 \times 2^{-2}) + \dots + (1 \times 2^{-20}) = 0.3$$

$$\text{Therefore the word value} = 0100 \ 0001 \ 0010 \ 0100 \ 1100 \ 1100 \ 1100 \ 1101$$

$$= 4124CCCD$$

Consequently for sensor 1 register 0001 = 4124 and register 0002 = CCCD

2) - 0.0000045

sign bit = 1

Exponent = -18, therefore exponent field =  $127 + (-18) = 109$ , and bits 30 to 23 = 0110 1101

The mantissa = 1.179648 which in binary representation = 1001 0110 1111 1110 1011 0101

$$\text{i.e. } (1 \times 2^{-18}) + (1 \times 2^{-21}) + (1 \times 2^{-23}) \text{ etc..} = 0.0000045$$

$$\text{Therefore the word value} = 1011 \ 0110 \ 1001 \ 0110 \ 1111 \ 1110 \ 1011 \ 0101$$

$$= B696FEB5$$

Consequently for sensor 1 register 0001 = B696 and register 0002 = FEB5

# Appendix G

## Hazardous Area Certification

**Appendix G Hazardous Area Certification**

The Condumax II is certified compliant to the ATEX Directive (2014/34/EU), the IECEx scheme and SI 2016 No. 1107 UKCA product marking scheme for use within Zone 1 & 2 Hazardous Areas and has been assessed as being so by ELEMENT MATERIALS TECHNOLOGY Ltd (Notified Body 2812) and ELEMENT MATERIALS TECHNOLOGY Ltd (Approved Body 0891).

The Condumax II is certified compliant to the applicable North American Standards (USA and Canada) for use within Class I, Division 1 and Class I, ZONE 1 Hazardous Locations and has been assessed as being so by QPS Evaluation Services Inc.

**G.1 Product Standards**

This product conforms to the Standards:

BS/EN60079-0:2018	IEC60079-0:2017
BS/EN60079-1:2014	IEC60079-1:2014
C22.2 No. 30-20 CSA	ANSI/UL 60079-0 7th ed.
C22.2 No. 60079-0-19 CSA	ANSI/UL 60079-1-7th ed.
C22.2 No. 60079-1-16 CSA	UL/ANSI 61010-1, 3rd ed.
C22.2 No. 61010-1-12 CSA	UL1203 5th ed.

**G.2 Product Certification**

**Using Michell BR or M.A.M. BREATHER**

ATEX & UKCA  
 II 2 G  
 Ex db IIB + H2 Gb  
 T6 (Tamb -40 °C...+44 °C)  
 T5 (Tamb -40 °C...+59 °C)

IECEX  
 Ex db IIB + H2 Gb  
 T6 (Tamb -40 °C...+44 °C)  
 T5 (Tamb -40 °C...+59 °C)

cQPSus  
 Class I, Division 1,  
 Groups B, C & D  
 T6 Tamb -25 °C...+59 °C

CL I ZONE 1  
 Ex db IIB+H2 Gb  
 AEx db IIB+H2 Gb  
 T6 (Tamb -40 °C...+44 °C)  
 T5 (Tamb -40 °C...+59 °C)

**Using Killark KQBA 1/2" NPT BREATHER**

ATEX & UKCA  
 II 2 G  
 Ex db IIB + H2 T3 Gb  
 Tamb -40 °C...+60 °C

IECEX  
 Ex db IIB + H2 T3 Gb  
 Tamb -40 °C...+60 °C

cQPSus  
 Class I, Division 1,  
 Groups B, C & D  
 T3 Tamb -25 °C...+60 °C

CL I ZONE 1  
 Ex db IIB+H2 T3 Gb  
 AEx db IIB+H2 T3 Gb  
 Tamb -40 °C...+60 °C

**Using Killark KQBA M20 BREATHER**

ATEX & UKCA  
 II 2 G  
 Ex db IIB T4 Gb  
 Tamb -40 °C...+60 °C

IECEX  
 Ex db IIB T4 Gb  
 Tamb -40 °C...+60 °C

cQPSus  
 Class I, Division 1,  
 Groups B, C & D  
 T4 Tamb -25 °C...+60 °C

CL I ZONE 1  
 Ex db IIB T4 Gb  
 AEx db IIB T4 Gb  
 Tamb -40 °C...+60 °C

### G.3 Global Certificates/Approvals

ATEX	TRAC11ATEX21319X
IECEX	IECEX TRC 11.0008X
UKCA	EMA21UKEX0002X
cQPSus	LR1507-7

These certificates can be viewed or downloaded from our websites at:  
[www.processsensing.com](http://www.processsensing.com) & [www.michell.com](http://www.michell.com)



**Special attention should be paid to the *Special Conditions for Safe Use* and the *Conditions of Certification* listed in the certificates shown on the website.**

### G.4 Special Conditions of Use

1. Do not open when an explosive gas atmosphere may be present.
2. External cables shall be compatible with a temperature of 80 °C (T6), 95 °C (T5) and 96 °C (T4/T3).
3. Maximum process pressure shall not exceed 138 bar when the Killark breather is fitted or 60 bar when the Michell/M.A.M breather is fitted.
4. Maximum combined process flow into the enclosure shall not exceed 1.5 LPM.
5. All process lines shall be purged to ensure the process gas or liquid is above its upper explosive limit before applying power.
6. Where painted or powder coated, the enclosures could present an electrostatic hazard. Clean only with a damp or anti-static cloth.
7. The enclosure is to be earthed externally using the earth point provided.
8. Only suitably ATEX / IECEX / UKCA / NRTL certified (as appropriate) cable glands and blanking elements shall be used.

Refer to the relevant sections within this manual for the connection, wiring and cable gland requirements.

### G.5 Maintenance and Installation

The Condumax II must only be installed by suitably qualified personnel and in accordance with the instructions provided and the terms of the applicable product certificates.

Maintenance and servicing of the product must only be carried out by suitably trained personnel or returned to an approved Michell Instruments Service Center.

Flame paths are not intended to be repaired.

# Appendix H

## Quality, Recycling & Warranty Information

**Appendix H      Quality, Recycling, Compliance & Warranty Information**

Michell Instruments is dedicated to complying to all relevant legislation and directives. Full information can be found on our website at:

**[www.michell.com/compliance](http://www.michell.com/compliance)**

This page contains information on the following directives:

- Anti-Facilitation of Tax Evasion Policy
- ATEX Directive
- Calibration Facilities
- Conflict Minerals
- FCC Statement
- Manufacturing Quality
- Modern Slavery Statement
- Pressure Equipment Directive
- REACH
- RoHS3
- WEEE2
- Recycling Policy
- Warranty and Returns

This information is also available in PDF format.

# Appendix I

## Analyzer Return Document & Decontamination Declaration

Appendix I Analyzer Return Document & Decontamination Declaration

**Decontamination Certificate**

**IMPORTANT NOTE: Please complete this form prior to this instrument, or any components, leaving your site and being returned to us, or, where applicable, prior to any work being carried out by a Michell engineer at your site.**

Instrument			Serial Number	
Warranty Repair?	YES	NO	Original PO #	
Company Name			Contact Name	
Address				
Telephone #			E-mail address	
Reason for Return /Description of Fault:				
Has this equipment been exposed (internally or externally) to any of the following? Please circle (YES/NO) as applicable and provide details below				
Biohazards			YES	NO
Biological agents			YES	NO
Hazardous chemicals			YES	NO
Radioactive substances			YES	NO
Other hazards			YES	NO
Please provide details of any hazardous materials used with this equipment as indicated above (use continuation sheet if necessary)				
Your method of cleaning/decontamination				
Has the equipment been cleaned and decontaminated?			YES	NOT NECESSARY
Michell Instruments will not accept instruments that have been exposed to toxins, radio-activity or bio-hazardous materials. For most applications involving solvents, acidic, basic, flammable or toxic gases a simple purge with dry gas (dew point <-30°C) over 24 hours should be sufficient to decontaminate the unit prior to return. <b>Work will not be carried out on any unit that does not have a completed decontamination declaration.</b>				
<b>Decontamination Declaration</b>				
I declare that the information above is true and complete to the best of my knowledge, and it is safe for Michell personnel to service or repair the returned instrument.				
Name (Print)			Position	
Signature			Date	



## NOTES



Instrument Expert  
Original factory  
packaging  
[www.keruiyiqi.cn](http://www.keruiyiqi.cn)

[www.ProcessSensing.com](http://www.ProcessSensing.com)



<http://www.michell.com>