



CDP301 – Condumax Dew-Point Tester User Manual



Please fill out the form(s) below for each instrument that has been purchased.

Use this information when contacting Michell Instruments for service purposes.

Product Name	
Order Code	
Serial Number	
Invoice Date	
Installation Location	
Tag Number	

Product Name	
Order Code	
Serial Number	
Invoice Date	
Installation Location	
Tag Number	

Product Name	
Order Code	
Serial Number	
Invoice Date	
Installation Location	
Tag Number	



CDP301 Dew-Point Tester

For Michell Instruments' contact information please go to
www.ProcessSensing.com

© 2023 Michell Instruments

This document is the property of Michell Instruments Ltd and may not be copied or otherwise reproduced, communicated in any way to third parties, nor stored in any Data Processing System without the express written authorization of Michell Instruments Ltd.

Contents

Safety	vii
Electrical Safety	vii
Pressure Safety	vii
Toxic Materials.....	vii
Repair and Maintenance.....	vii
Safety Conformity	vii
Abbreviations.....	viii
Warnings	viii
1 INTRODUCTION	1
1.1 Sample Gas Path.....	1
1.2 Operating Overview.....	2
1.3 User Display and Interface.....	2
1.4 Calibration	2
1.5 Storage Instructions	2
2 INSTALLATION	4
2.1 Sample Gas Connections.....	5
2.2 Electrical Safety	6
2.3 Hazardous Area Safety	7
2.4 Gas Sample Connections.....	8
2.4.1 Connecting the Michell Sample System (optional accessory).....	8
2.4.2 Considerations when setting sample pressure and flow	9
3 OPERATION	10
3.1 Menu Map	11
3.2 User Interface.....	12
3.2.1 Front Page A Navigation	15
3.2.2 Front Page B Navigation	17
3.2.3 Front Page C Navigation	18
3.2.4 Configuration Page.....	20
3.2.4.1 Measurement Configuration Page	21
3.2.4.2 Logging Configuration Page	23
3.2.4.3 Site Labels.....	24
3.2.4.4 Display	25
3.2.4.5 Enhanced Analysis Modes	26
3.2.4.6 Real Time Clock (RTC).....	27
3.2.4.7 Camera Configuration.....	28
3.2.4.8 Battery Status.....	29
3.2.4.9 About.....	29
3.2.4.10 Service.....	30
4 SYSTEM START-UP AND MEASUREMENT PROCEDURE.....	32
4.1 Taking a measurement	32
4.1.1 User Interface Controls.....	32
4.1.2 Display Meanings	33
4.1.3 Recording or Capturing an Image.....	33
4.1.4 Step-By-Step Measurement Guide	34
4.2 System Shut-Down Procedure	38
4.3 Battery Replacement	38
4.4 Battery Charging (within the dew-point tester).....	39
4.5 Spare Battery Charging.....	40
4.6 Data Access.....	40

5	MAINTENANCE	41
5.1	Calibration	41
5.2	Filter Element Replacement	41
5.3	Mirror Cleaning	42
5.3.1	CDP301 Preparation	42
5.3.2	Opening Measurement Cell	43
5.3.3	Removing Particulates	44
5.3.4	Removing Residue.....	45
5.3.5	Reassemble Sample Cell	45
5.3.6	Check Mirror Cleanliness.....	46

Figures

Figure 1	Dimensions and Gas Connections	4
Figure 2	Michell Sample System	8
Figure 3	Menu Map	11
Figure 4	Push Button Operation.....	12
Figure 5	Initialization Screen	12
Figure 6	Front Page A – Default	13
Figure 7	Front Page A – Quick Menu.....	16
Figure 8	Front Page B – Pop Up.....	17
Figure 9	Front Page C – Main Page.....	18
Figure 10	Still Image View	19
Figure 11	Full-screen Video View.....	19
Figure 12	Log File View	20
Figure 13	Configuration Menu – Measurement Page	21
Figure 14	Configuration Menu – Logging Page.....	23
Figure 15	Configuration Menu – Site Label Page.....	24
Figure 16	Configuration Menu – Display Page.....	25
Figure 17	Wdp Image.....	26
Figure 18	Split Screen Mode	26
Figure 19	Configuration Menu – RTC Page	27
Figure 20	Configuration Menu – Camera Page.....	28
Figure 21	Configuration Menu – Battery Page.....	29
Figure 22	About Info	29
Figure 23	HCdp LED Intensity	30
Figure 24	Save Current Setup	30
Figure 25	Save Current Setup – Confirmation.....	31
Figure 26	Retrieve Saved Setup	31
Figure 27	Image Capture / Recording	33
Figure 28	Front Page A.....	34
Figure 29	Measurement Menu.....	34
Figure 30	Quick Menu	35
Figure 31	Configuration Menu – Display Page.....	35
Figure 32	Quick Menu	36
Figure 33	Configuration Menu – Measurement Page	37
Figure 34	Split Screen (HCDP) mode	37
Figure 35	Remove Charger Cover.....	39
Figure 36	Connect Charger Lead	39
Figure 37	Spare Battery Charging.....	40
Figure 38	USB Port.....	40
Figure 39	Cleaning Accessories	42
Figure 40	Lid Removal.....	43
Figure 41	Display Opened.....	43
Figure 42	Camera USB Connection	44
Figure 43	Camera Sensor In-line Connector	44
Figure 44	Checking the Mirror Surface	44
Figure 45	Camera Assembly.....	45
Figure 46	Screw Tightening Order.....	45

Appendices

Appendix A	Technical Specifications.....	46
	A.1 Dimensions.....	47
Appendix B	Hazardous Area Certification	49
	B.1 Product Standards.....	49
	B.2 Product Certification	49
	B.3 Global Certificates/Approvals.....	49
Appendix C	Quality, Recycling, Compliance & Warranty Information	51
Appendix D	Analyzer Return Document & Decontamination Declaration	53

Safety

This manual contains all the required information to install, operate and maintain this product. It should be read and understood prior to use. Installation and operation of this product should be carried out by suitably competent personnel only and must be in accordance with the terms of this manual and associated safety certificates. Incorrect installation and operation of this product for other than its intended purpose will render all warranties void.

This product is intended for use in a Hazardous Area and is ATEX, IECEx and UKCA approved. It is also approved for use in North America in accordance with the requirements for the USA and Canada. The relevant certificates should be fully examined and understood prior to installation or use of this product.

Electrical Safety

The instrument is designed to be completely safe when used with options and accessories supplied by the manufacturer for use with the instrument.

Pressure Safety

DO NOT permit pressures greater than the safe working pressure to be applied to the instrument. The specified safe working pressure is 100 barg (1450 psig). Refer to the Technical Specifications in Appendix A.

Toxic Materials

The use of hazardous materials in the construction of this instrument has been minimized. During normal operation it is not possible for the user to come into contact with any hazardous substance which might be employed in the construction of the instrument. Care should, however, be exercised during maintenance and the disposal of certain parts.

Repair and Maintenance

The instrument must be maintained either by the manufacturer or an accredited service agent. For Michell Instruments' contact information please go to www.ProcessSensing.com.

Safety Conformity

This product meets the essential protection requirements of the relevant UK, EU and US standards and directives. Further details of applied standards may be found in the Technical Specifications in Appendix A.

Abbreviations

The following abbreviations are used in this manual:

barg	pressure unit (=100 kP or 0.987 atm) (bar gauge)
°C	degrees Celsius
°F	degrees Fahrenheit
DC	direct current
g	grams
in	inch(es)
µm	micrometer
m/sec	meters per second
mA	milliampere
mm	millimetres
MPa	megapascal
NI/min	normal litres per minute
Nm	Newton meter
oz	ounces
psig	pounds per square inch
RH	relative humidity
scfh	standard cubic feet per hour
fps	feet per second
T	temperature
V	Volts
Ω	Ohms
∅	diameter

Warnings

The following general warning listed below is applicable to this instrument. It is repeated in the text in the appropriate locations.



Where this hazard warning symbol appears in the following sections it is used to indicate areas where potentially hazardous operations need to be carried out.

1 INTRODUCTION

The CDP301 provides battery-powered manual visual measurement of the hydrocarbon dew point and water dew point of processed natural gas. It is the result of more than 30 years' experience in the supply of dew-point testers to the worldwide oil, gas and petrochemical industry.

The system consists of a hydrocarbon and water dew-point sensor cell and control electronics housed in an Exd enclosure. A sample gas handling system to prepare the gas sample prior to entry into the CDP301 Dew-Point Tester can also be supplied. The dew-point tester is designed to be positioned close to the process sample test point. It is ATEX, IECEx and UKCA approved and is also approved for use in North America in accordance with the requirements for the USA and Canada. These and additional International approvals are listed in the Certification section of this manual. Certificates are available on the Process Sensing Technologies website. A marking label located on the analyzer will identify appropriate approvals.

The enhanced cooled-mirror principle of the CDP301 allows easy detection of hydrocarbon or water dew point with the ability to review what has been observed later. Key components of the dew-point tester are measurement cell, metallised-ceramic mirror with integrated PT1000 resistance thermometer, triple-stage TEC (thermo-electric cooler), hi-resolution color camera, color LCD display, tactile button HMI, operation and measurement electronics, and rechargeable battery pack.

Standard accessories include a wheeled transport/storage case (suitable for non-hazardous/safe area locations only) and backpack (of anti-static material) to carry the CDP301 and sampling system to the location of use. A universal AC supplied battery charger is provided (which must only be operated in safe area location). Spare battery, sampling system and sample hoses are also available as optional accessories.

1.1 Sample Gas Path

The CDP301 measurement system must be supplied with gas at the required pressure and flow via a sample gas handling panel. Sample gas entry and exit ports pass the gas through flame arrestors. **The inlet connection has a flow restriction device fitted. This is a mandatory safety device that limits pressure rise within the Exd enclosure in the event of a gas leak occurring. The flow restriction device must not be removed.**

The dew-point tester system components are housed within a cast, copper free aluminium EExd rated enclosure. The enclosure has a screw cover incorporating a sealed window. It is chromate primed, polyester coated in black, and provides environmental ingress protection to IP64 (NEMA4 equivalent). An enclosure breather is fitted in the form of an additional flame arrestor. It is important that no pipe connection is made to this breather and that no restriction is allowed to occur.

All sample wetted metallic parts are manufactured in AISI 316L stainless steel with Viton soft parts that comply with the NACE standard MR-0175 (latest edition). Tube fittings are twin ferrule Swagelok© compression type.

1.2 Operating Overview

The CDP301 is a manual visual instrument. It is designed to follow the requirements as described in ASTM D1142 and ISO6327. Using a simple button push, the measured hydrocarbon and water dew-point temperature, pressure, date and time are stored and indexed for review and retrieval/download at a later date.

1.3 User Display and Interface

The CDP301 Display and User Interface (UI) is presented via the circular window of the enclosure. The unit is operated using 5 buttons, which allows full control of the UI. The cover is fully detachable for greater access into the enclosure for service. During normal operation of the instrument the cover must remain fully secured.

1.4 Calibration

Prior to shipment, the cooled-mirror dew-point sensor within the instrument undergoes stringent factory calibration using high purity hydrocarbon gas of known dew point. Due to the inherent stability of the instruments, only periodic calibration maintenance is required under normal operating conditions. (See Maintenance Section below.)

1.5 Storage Instructions

The CDP301 has been designed for the accurate manual visual detection of hydrocarbon and water dew point within natural gas. In order for the dew-point tester to be functional upon use it should be stored in accordance with the guidelines below:

- The dew-point tester must be housed in a sheltered area, out of direct sunlight and rain.
- The dew-point tester should be stored to minimize the possibility of sitting in ground water.
- The temperature within the storage environment should be maintained between 0 and +50 °C (+32 and +122 °F).
- The humidity within the storage environment must be non-condensing.
- The storage environment must not expose the dew-point tester to any corrosive elements.
- The dew-point tester may stay assembled with its sample conditioning system (if supplied).
- All process connections should remain disconnected.
- All protective coatings should remain in place until use.

For the period from first use of the CDP301, the following precautions should be followed:

- The dew-point tester and associated sampling system must remain isolated from the process gas, and the enclosure should remain closed to ensure ingress protection is maintained.
- At time of start-up the procedures contained in this manual must be followed.

If the CDP301 was previously in service/operation, then the following precautions should be followed before storage:

- Upon isolation from the gas sample the entire system should be purged with dry nitrogen gas before powering down of the dew-point tester.
- All connections and ports (gas and electrical) to the dew-point tester or sample system (if provided) should be capped.
- If the dew-point tester is not removed from its location, the electrical earthing of the instrument should remain in place.

2 INSTALLATION

The product should be used in a fixed position as per the full installation instructions provided in this User’s Manual.

The combined weight of the instrument and measurement cell is <8kg (17.6lb). Appropriate lifting and handling techniques should be used during the carrying and installation process. Before commencing any lifting or handling ensure that the intended location is suitable and appropriately prepared. Make sure that mounting point design considerations have employed locally approved safety factors. When handling and installing this instrument (particularly after removal from its packaging) ensure that it is not dropped, impacted or subjected to high levels of vibration or environmental conditions that may impair its operation.

The CDP301 is housed in a copper-free, aluminium Exd enclosure suitable for 5/8” -11 UNC tripod mounting and benchtop operation, using the Michell Instruments benchtop stand. The enclosure provides environmental ingress protection IP64 and can be mounted vertically or horizontally in a location free of any appreciable vibration. If used outdoors, it should be placed in a shaded position to prevent heating effects through sun radiation.

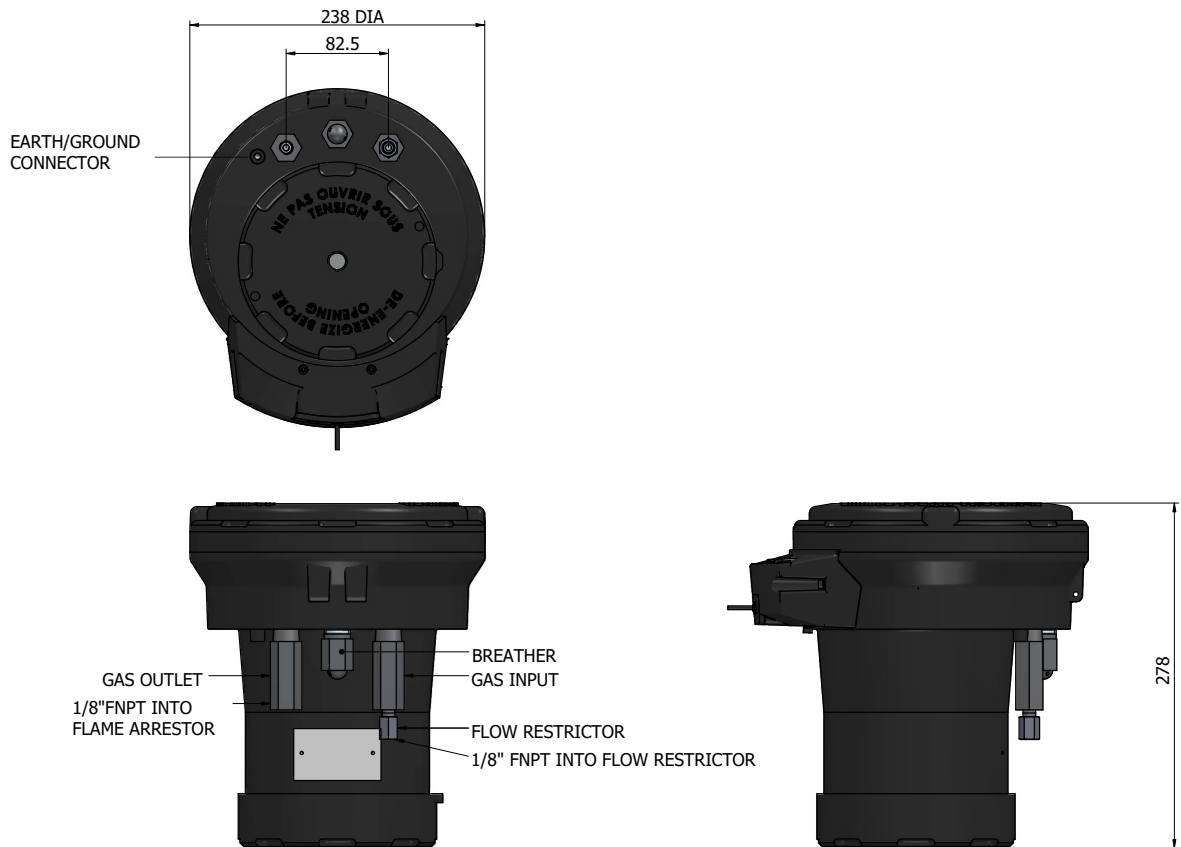

Figure 1 Dimensions and Gas Connections

2.1 Sample Gas Connections



WARNING

Ensure process sample gas supply line is well flushed through to clear any liquid/debris present, prior to connecting onto the dew-point tester.

Sample gas connections (without sample system) are:

- Sample Gas Inlet: 1/8" NPTF *into Flow Restrictor*
(100 barg/1450 psig maximum supply pressure)
- Sample Gas Outlet: 1/8" NPTF into Flame Arrestor

2.2 Electrical Safety

The CDP301 is powered by a li-ion battery rated at 14.6 V, 5.6Ah and 81.8 Wh

A single-phase AC mains power supply is required to charge the li-ion battery; refer to Michell Instruments spares and replacements guide for more details. Charging and replacement of the batteries **MUST** be carried out in a safe area!



WARNING

Ensure the earth point on the enclosure is connected to ground during operation in the hazardous area!

During the installation of this product ensure that all applicable national and local electrical safety regulations are observed.

Always ensure that power is switched off prior to accessing the product for any purpose other than normal operation.

This product is designed to operate, as a minimum, between a temperature range of -30...+50 °C (-22...+122 °F) (see marking label for full certification details), in maximum 95 % relative humidity.

Supply of power to the CDP301 must be provided by Michell Instruments internal battery pack and/or the supplied Michell Instruments power supply.

Do not exchange or tamper with any of the cables or electrical components supplied with this product. Doing so will invalidate all warranties.

There are no additional or special electrical safety requirements other than those referred to in this manual.

Do not install this equipment in a location that would expose it to impact or high levels of vibration.

Operation of this equipment, other than in a manner specified by the manufacturer, may impair the safety protections provided.

The safe installation of this equipment and any system incorporating this equipment is the responsibility of the installer.

Ensure local regulations and requirements are referred to prior to any installation commencing.

2.3 Hazardous Area Safety

Refer to Appendix B for the Hazardous Area Certification of this product.

This product is fitted with a marking label that contains Hazardous Area information pertinent to the suitable location and installation.

During all installation and operation activities, local regulations and permitted working routines must be observed. Installation and/or operation should only be performed by competent personnel and in accordance with the latest version of IEC/EN60079-14 or local equivalent. Repair and servicing of this equipment must only be carried out by the manufacturer.

WARNING

This product is certified for use in a Zone 1 and Zone 2 area only. This product must not be installed or used within a Zone 0 area.



WARNING

This product must not be operated outside of the temperature range -30 °C *...+50 °C (-22 °F...+122 °F).

*** See marking label for full certification details.**

WARNING

The enclosure of this product provides Exd protection, partly through threads used for mounting the lids. At all times, effort should be made to ensure these threads are suitably protected from damage.

An Installation and Maintenance Information Sheet is supplied separately to the manual.

The enclosure of this product must be connected to earth/ground during use. An M6 earth/ground point is located alongside the gas outlet flame arrestor.



WARNING

A flow restrictor is fitted to the inlet gas connection. This critical safety device must be in place whenever the product is operated. Removal of this device will contravene safety regulations and negate the Ex certification applicable to this instrument.

2.4 Gas Sample Connections

The following points should be considered when installing the sample gas supply line:

- PTFE tape is recommended for pipe connections.
- Solvent-based pipe thread sealant should not be used, as condensable components or contaminants can be leached during the curing period.

Care and attention to the position and installation of the tubing will minimize problems caused by avoidable contamination. The most common issue with sample flow is the accumulation of liquid in impulse lines during a shutdown period. If the measurement system has not been isolated, condensate can be displaced, on re-start, into components and associated tube work. An optional CDP301 sample system is available from Michell Instruments:

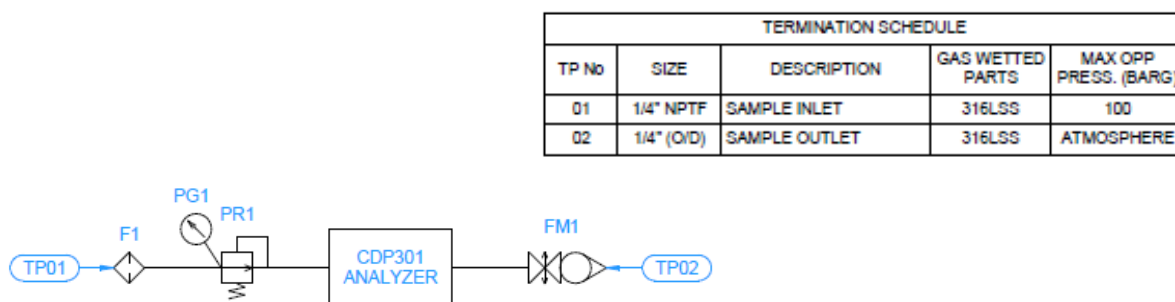

Figure 2 Michell Sample System

2.4.1 Connecting the Michell Sample System (optional accessory)

DO NOT permit pressures greater than the specified safe working pressure of 100 barg (1450 psig) to be applied directly to the instrument.

Ensure the instrument is properly secured before use, i.e. tripod mounted or fitted to a suitable benchtop mounting.

1. Ensure the isolation valve to the sample tapping point is fully closed.
2. Connect the Michell sample system to the CDP301 inlet and outlet connections and tighten the fittings.
3. Ensure pressure regulator PR1 is fully closed.
4. Connect the sample tapping point to the sample system using suitable stainless steel tubing or high-pressure rated hose (such as Swagelok B series).
5. Connect the vent line (if available) to the flowmeter's 1/4" FNPT outlet connection and ensure the isolation valve (if fitted) is fully open.
6. Refer to Section 4, SYSTEM START-UP AND MEASUREMENT PROCEDURE, for tester operation.

For proper sample system operation, Michell Instruments' recommendations are:

- The sampling point from the process line should be taken from the top of the process line. If a radial probe is used, the orifice should face downstream.
- It is recommended that Viton is used for all O-rings.
- The internal volume of the impulse tubing connecting between the process line and this product should be as small as possible to minimize response lag time to changing process conditions.
- Piping should be lagged and/or trace heated if ambient temperatures could cause the sample gas to fall below its dew-point temperature.
- A drain valve should be placed at the lowest point in the system.
- It should be standard procedure to isolate this product during shutdowns or when plant problems are being experienced and to adequately purge the supply lines before restarting.
- The relatively large area of surfaces and internal volume of inline components can be particularly troublesome if contamination is experienced. Prolonged purging, or stripping and cleaning, followed by re-purging with gas may be necessary to remove the contamination.
- Avoid sample gas streams that are already very close to the dew point or which have dispersed liquid within them. In such cases, sampling from fast loops and/or from downstream of existing catch pot/coalesce systems is always preferred.

Failure to observe these recommendations will potentially cause problems of contamination as well as causing consequential inaccurate, unreliable and inconsistent measurement results. If a top-entry sample point is not available, extra attention should be given to the design of the sample line installation to avoid unwanted contamination.

2.4.2 Considerations when setting sample pressure and flow

In-line particulate filtration is recommended to avoid contamination of the mirror surface and generally within the dew-point tester. A 15 micron (or smaller) sintered stainless steel filter is suitable.

Pressure within the dew-point sensor cell is indicated on the display of the CDP301. Be aware that the flow restrictor fitted to the gas inlet connection will cause a small pressure drop between supply pressure and analysis pressure within the dew-point sensor cell. Process pressures less than 20 barg (290 psig) cannot be sampled.

Set the sample flow rate to 0.5 NI/min (0.03 Nm³/hr)

The sample gas outlet should be vented to atmosphere (where permitted and in accordance with safety procedures at the location of use) or exhausted into a low-pressure flare system (<3 barg/43.5 psig back-pressure).

3 OPERATION

Familiarization with the operation of the CDP301 should be carried out in conjunction with this User's Manual prior to commencing system start-up procedure.

Before commencing the start-up procedure, it is essential to ensure the installation conforms to the correct hazardous area and local plant standards and that all mains power connections are fully isolated.

Before any gas pressure is applied, check all gas connections are fully tightened up.

**WARNING**

This product is used with pressurized gas. Observe correct gas handling precautions.

3.1 Menu Map

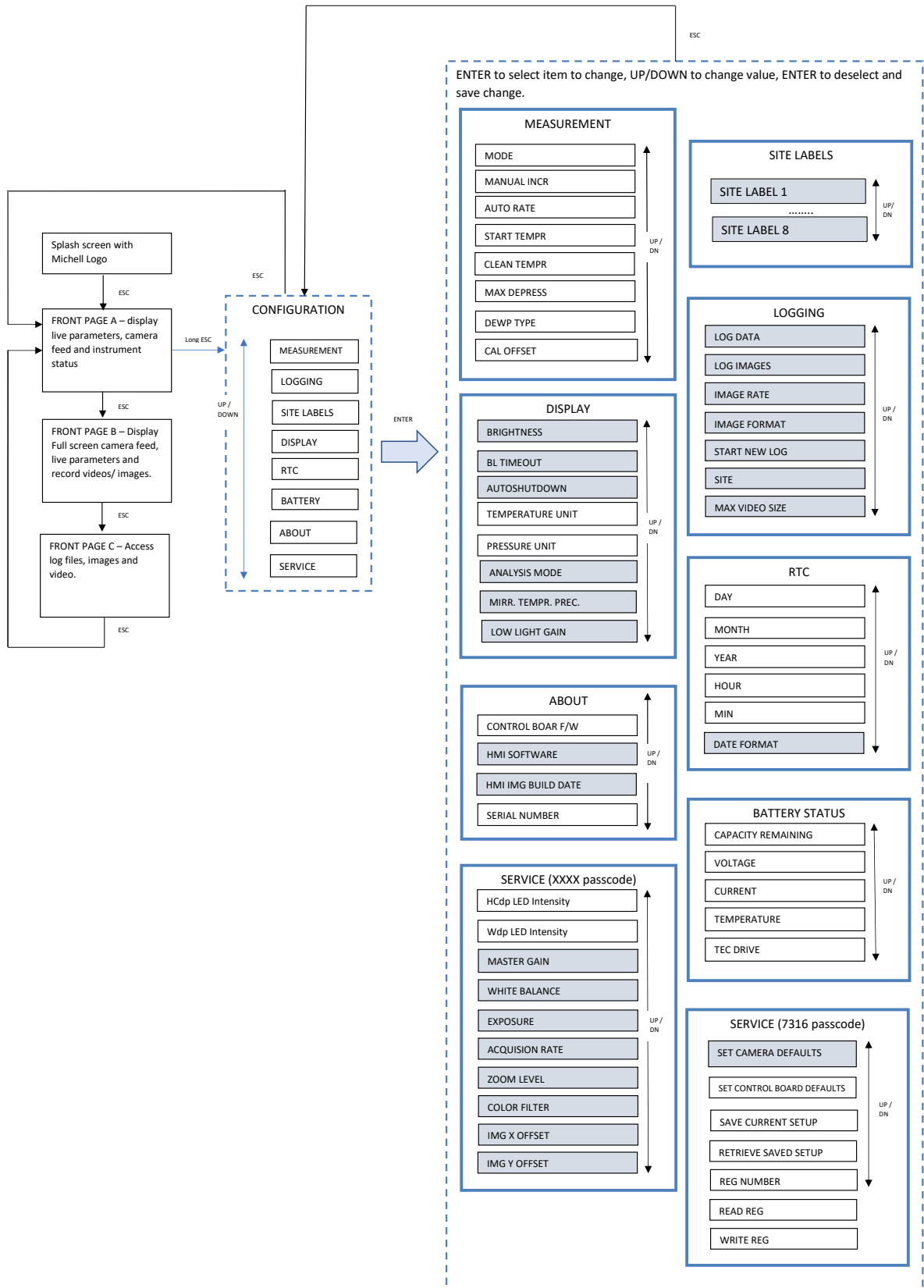

Figure 3 Menu Map

3.2 User Interface

The CDP301 is operated using 5 discrete momentary push buttons as shown below:

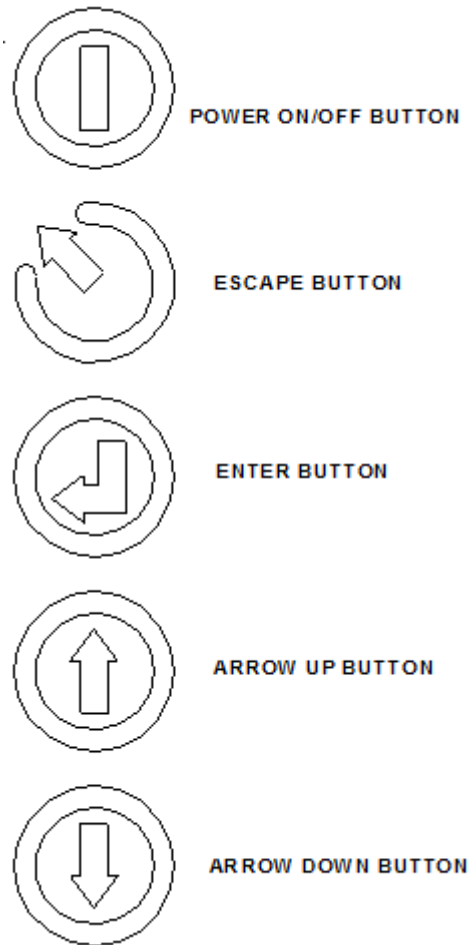

Figure 4 *Push Button Operation*

Press and hold the Power On/Off button. On power up, a splash screen will be shown during software initialization.

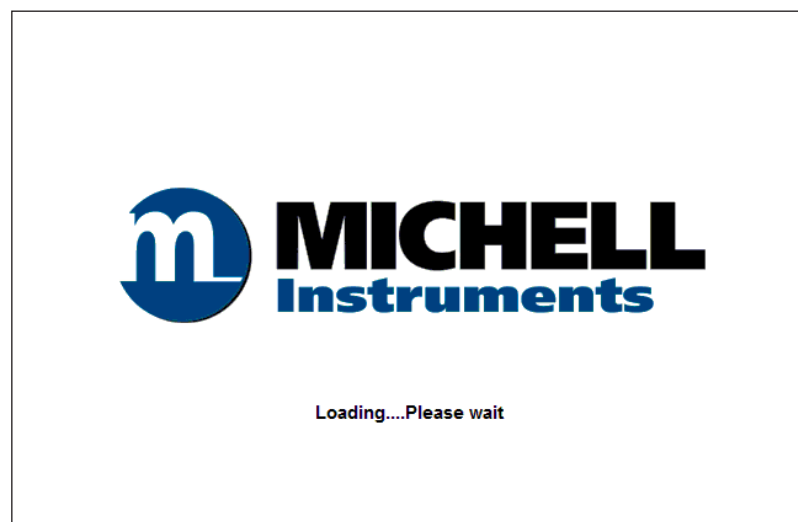

Figure 5 *Initialization Screen*

After initialization is complete, the following display (Front Page A) will appear. The screen displays measured parameters, instrument status and camera live feed.

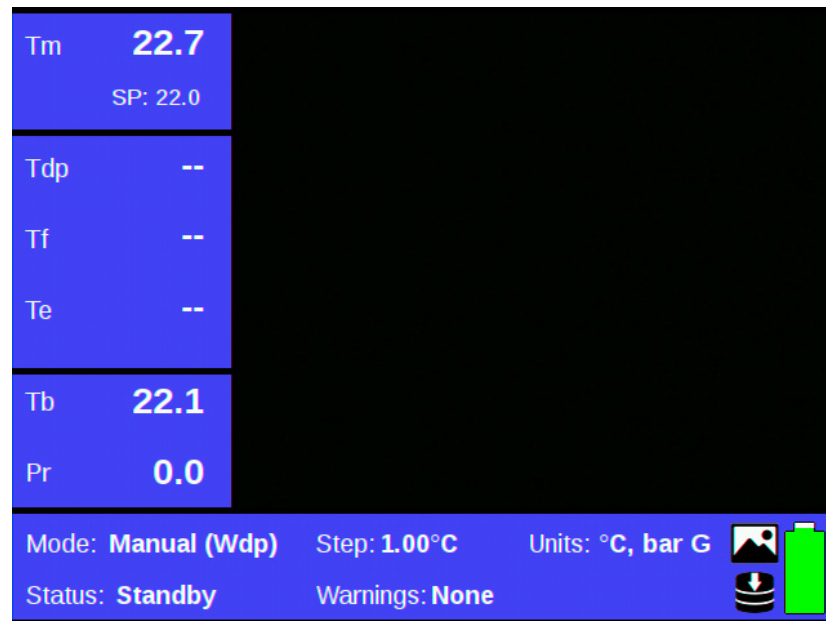

Figure 6 *Front Page A – Default*

There are 3 main front page displays for the CDP301: A, B & C.

When navigating the CDP301 user menu the following abbreviations will be observed:

- Tm = Current Mirror Temperature
- SP = Current mirror Set point temperature. When instrument is in AUTO mode and when selected to do so, this value will change according to the AUTO RATE. When instrument is MANUAL mode and when selected to do so, this value will change according to the MANUAL STEP.
- Tdp = Calculated dew-point temperature (calculated average of Tf and Te)
- Tf = Formation temperature. The user-determined mirror temperature of dew formation.
- Te = Evaporation temperature. The user-determined mirror temperature of dew evaporation.
- Tb = Body temperature
- Pr = The sensor cell gas pressure (in user selected PRESSURE UNIT).

The status bar also contains the following information:

Mode: Water (WD) or Hydrocarbon (HCdp) dew-point measurement mode

- Auto (WD or HCdp); Automatic mirror temperature ramp in °C/min
- Manual (WD or HCdp); manual temperature increment in °C

Step: Mirror temperature setpoint step change as configured in MANUAL INCR for Manual mode only

Rate: Mirror temperature setpoint rate of change as configured in AUTO RATE for Auto mode only

Units:

- Degrees; C or F
- Pressure; barG, MPaG, psiG

Status: Measurement status of instrument. One of 5 states will be displayed:

- Start – Mirror temperature setpoint is set to the START TEMPR
- Measure – In normal measurement mode where user is controlling the mirror temperature
- Cleaning – Mirror temperature setpoint is set to $T_b + \text{CLEAN TEMPR OFFSET}$
- Limited – Mirror temperature has been capped or limited for safety. Capped at $T_b - \text{MAX DEPRESS}$ and $T_b + \text{CLEAN TEMPR OFFSET}$.
- Standby – The instrument sets the mirror temperature setpoint to the T_b (body temperature) and turns off drive to the TEC (Thermo-Electric Cooler) under these warning or error conditions:
 - Mirror temperature error
 - Enclosure temperature error
 - TEC Fault
 - Battery temperature
 - The unit is manually set to standby
 - After a system reset

Warnings: Active warning or error messages are displayed in turn.

- "Mirror temperature error" (Faulty mirror temperature sensor)
- "Enclosure tempr. error" (Faulty enclosure temperature sensor)
- "Pressure sensor error" (Pressure sensor malfunction)
- "Battery level" (Battery remaining capacity <10 %)
- "Battery temperature" (Battery overheating to >80 °C/176 °F)
- "TEC fault" (Open/ short circuit TEC or wiring to it)
- "Battery Error" (Battery communication malfunction)
- "Camera comms" (Problem with communication between main board and camera)
- "Control board comms" (Problem with communication between main board and control board)
- "None" (No warnings or errors detected)

Icons:

Indicates that LOG IMAGES function is on. Images will be captured and saved to the internal storage.



Indicates that LOG DATA function is on. Measurement Data will be saved to the internal storage



Battery warnings are summarized below:

- <20 % battery capacity = Red bar in battery symbol
- <10 % battery capacity = Red bar in battery symbol and warning message "Battery level"
- <5 % battery capacity = Red bar in battery symbol and warning message "Battery level" plus AUTO SHUTDOWN if configured ON.

3.2.1 Front Page A Navigation

Auto Mode controls:

- Long ENTER press – open Quick Menu
- First UP arrow press – ramp up mirror temperature by set rate
- Second UP arrow press – pause mirror temperature ramp up
- First DOWN arrow press – ramp down mirror temperature by set rate
- Second DOWN arrow press – pause mirror temperature ramp down
- Short ESC (ESCAPE) press – scrolls to Front Page B, then Front Page C
- Long ESC press – go to configuration page

Manual Mode controls:

- Long ENTER press – open Quick Menu
- UP arrow press – Increase mirror temperature by 1 increment (Step size shown in Status Bar)
- DOWN arrow press – Decrease mirror temperature by 1 increment
- First short ENTER press – save condensation formation temperature (Tf)
- Second short ENTER press – save evaporation temperature (Te) and dew point (Tdp).
- Third short ENTER press – clears values
- Short ESC press – scrolls to Front Page B, then Front Page C
- Long ESC press – go to Configuration Page

If ramp is in paused state:

- First short ENTER press – saves condensation formation temperature (Tf)
- Second short ENTER press – saves evaporation temperature (Te) and dew point (Tdp).
- Third short ENTER press – clears values
- Short ESC press – scrolls to Front Page B, then Front Page C
- Long ESC press – go to configuration page

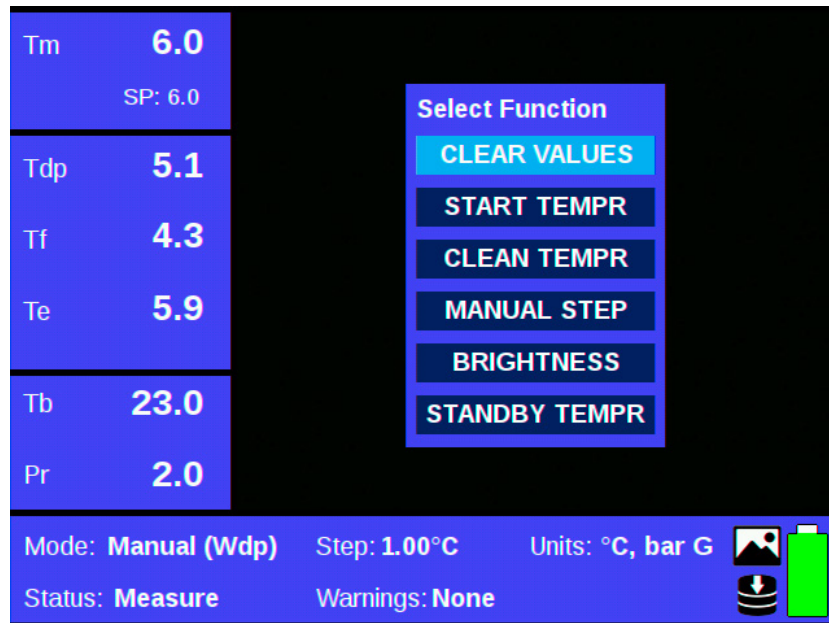

Figure 7 *Front Page A – Quick Menu*

Front Page A – Quick Menu Controls

- Clear Values – Cancels and clears Tdp, Tf and Te values ready for a new measurement
- Start Tempr – Sets the mirror temperature setpoint to the START TEMPR
- Clean Tempr – Sets the mirror temperature setpoint to the CLEAN TEMPR which is calculated as Tb + CLEAN TEMPR OFFSET
- Manual Step – Navigates to the manual step option in the configuration menu
- Brightness – Navigates to the display brightness option in the configuration menu
- Standby – Sets the mirror temperature setpoint to the tb value and power to the TEC is turned off.
- Take Ref Img (Take Reference Image) – This function is only available in one of the enhanced ANALYSIS MODES. All enhancement modes utilize a reference image. Select this function to take a reference image. Normally done when the mirror is clean (heated).

3.2.2 Front Page B Navigation

Front Page B shows a full screen image of the mirror surface. From this screen it is possible to view and capture still images or video of the mirror surface during measurement.

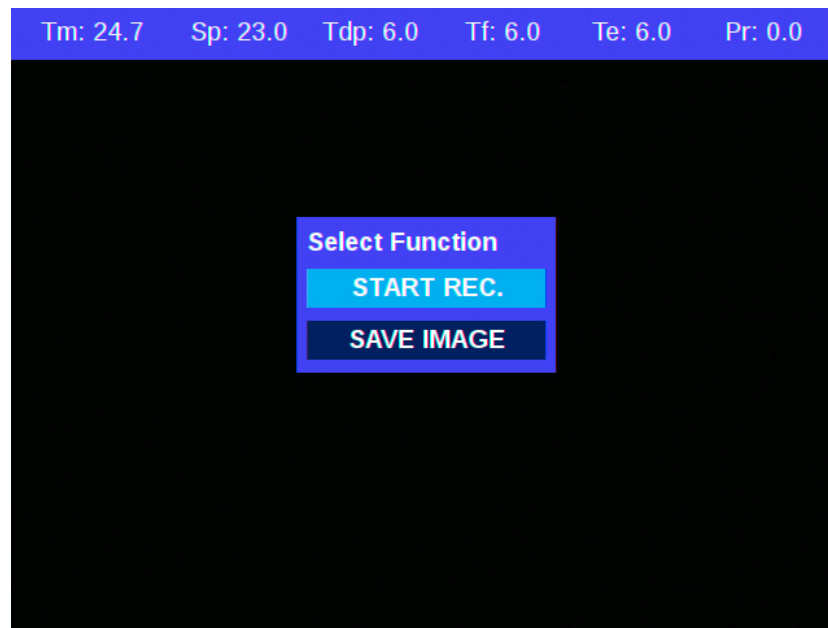

Figure 8 *Front Page B – Pop Up*

Front Page B controls:

- Long ENTER press – open Quick Menu
- Start Rec. / Stop Rec. – Start the recording of video or stop the recording of video. A red circle will flash at the top right of the display to indicate that a video is being recorded.
- Save Image – Saves an image of the current Front Page B (excludes the pop-up menu). A red circle will momentarily appear at the top right of the display to indicate that an image has been saved.

3.2.3 Front Page C Navigation

Front Page C controls:

From this page, saved Logs, Images and Videos can be viewed or deleted*. The 3 file types are stored in separate folders and are accessed by scrolling UP or DOWN using the arrow buttons and pressing ENTER to select the desired log file.



Figure 9 Front Page C – Main Page

Video recording is 5MB/min in MP4 format. The unit can store ~300 minutes of video clips.

Still images are JPEG or PNG format, full color 200KB size for HCdp Dew-Point Type or red filtered 50KB size for Wdp Dew-Point Type.

Total storage capacity for video, still image and log files is 2GB.

* If the instrument is connected to a PC via the USB connection, then it will not be possible to view any files in this page until the USB is disconnected.

Images will be available to view either within the Images folder or within the logged data folders. The images are listed in chronological order with the newest at the top.

- Pressing ENTER will display the image in full screen.
- Pressing ESC will cancel the full screen view.
- A long press of ENTER will give the user the option to delete the image via a pop-up confirmation box.

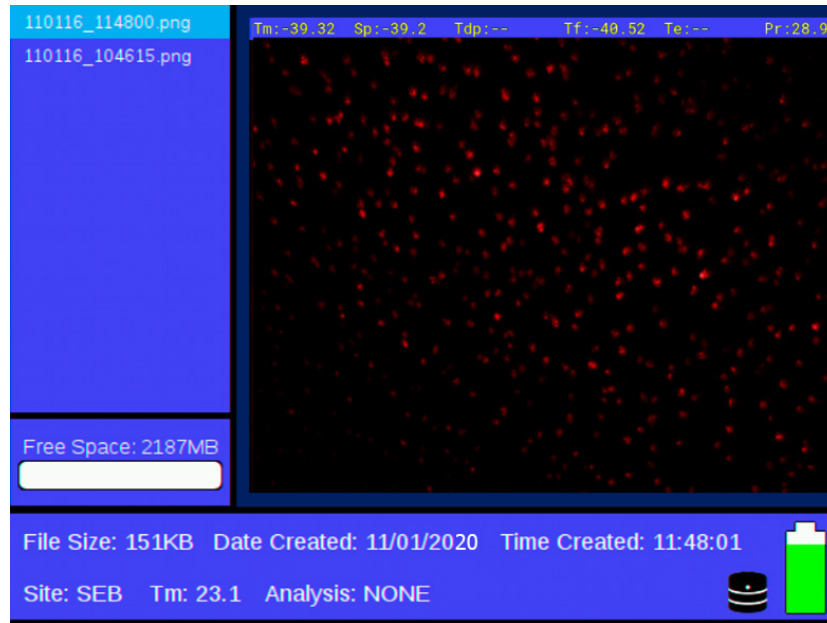

Figure 10 *Still Image View*

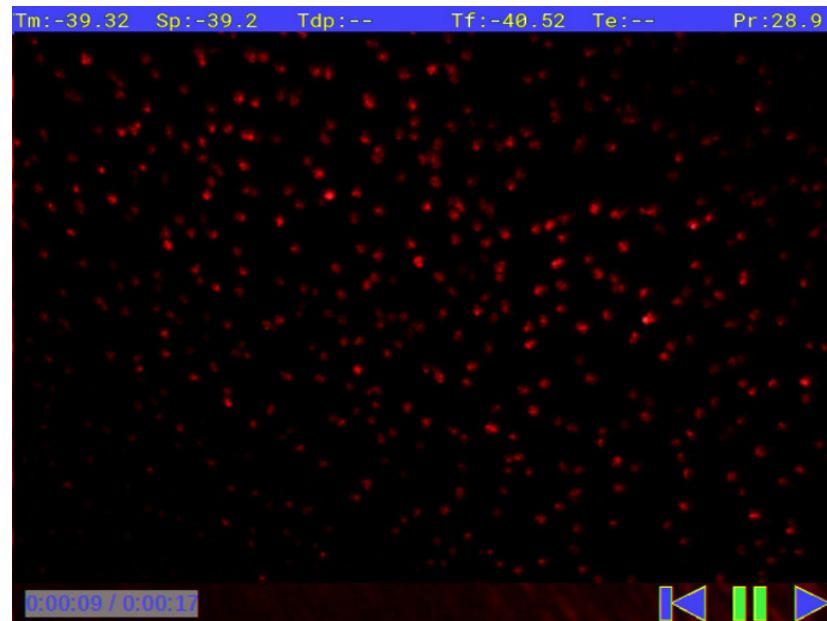

Figure 11 *Full-screen Video View*

Log Data File:

Log files and associated images will be available to view within the logs folder. The logs are listed in chronological order with the oldest at the top. Log data (.csv file) will be displayed in tabular form in the viewing pane as soon as they are selected in the explorer pane.

- Pressing **ENTER** will allow scrolling through the log data vertically.
- Pressing **ENTER** again will allow scrolling the log data horizontally.
- Pressing **ESC** will cancel the full scrolling playback.
- A long press of **ENTER** will give the user the option to delete the log file via a pop-up confirmation box.

Date	Time	Site	Dp	Tf	T
14/11/2019	08:15:35	SEB	4.4	4.2	
14/11/2019	08:15:48	SEB	7.8	7.6	

Free Space: 2185MB

File Size: 738B Date Created: 14/11/2019 Time Created: 08:15:48

Figure 12 Log File View

Images in the logs data folder may be viewed in the same way as described in Section 3.2.3.

Note that any images suffixed with an "RI" are images taken automatically by the instrument (when cleaning mirror) as reference images for use in ANALYSIS MODE calculations. These images may be normally ignored by the user.

3.2.4 Configuration Page

- **Enter** key press – access options table
- **Arrow** keys press – scroll through options table
- **ESC** key press – exit options table

The configuration menu allows access to the following sub-menus:

- Measurement
- Logging
- Site Labels
- Display
- RTC
- Camera
- Battery
- About
- Service

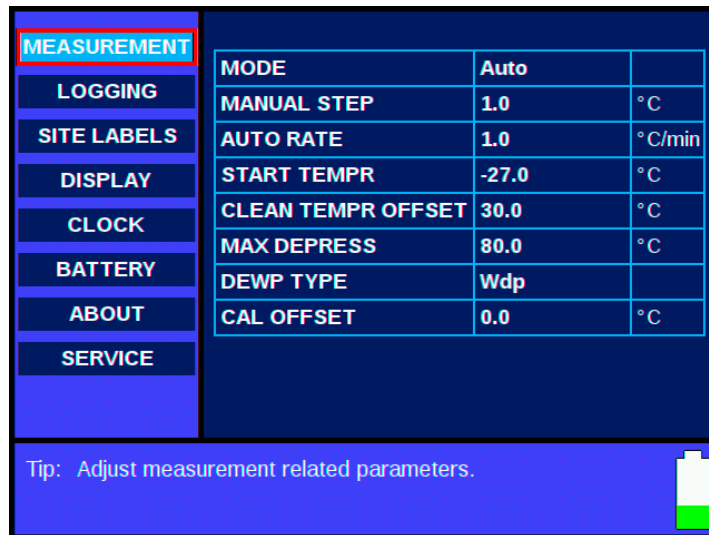

Figure 13 Configuration Menu – Measurement Page

3.2.4.1 Measurement Configuration Page

Allows the user to modify measurement parameters to suit the required process conditions.

- Enter key press – access options table
- Arrow keys press – scroll through options table
- ESC key press – exit options table

Mode

Manual, Auto – selection of Instrument mode of operation.

If Manual selected than the Up/Down buttons will change the mirror temperature set point by the Manual Increment setting.

If Auto selected than the Up/Down buttons will start ramping mirror temperature up or down at the Auto Rate setting. Press the same button again to pause the cooling/heating ramping.

Manual Increment (MANUAL INCR)

0.1...5.0 °C (32.18...41 °F) in 0.1 °C (0.18 °F) increments – the mirror temperature set point adjustment increment in Manual mode.

Auto Rate

0.5...10.0 °C/min (32.9...50 °F) in 0.5 °C (1 °F) increments – the mirror temperature rate of change in Auto mode.

Start Temperature (START TEMPR)

-90...50 °C (-130...122 °F) in 1 °C (1.8 °F) increments – set point that the user believes is close to the dew-point temperature from where the user can begin the measurement.

Clean Temperature (CLEAN TEMPR)

-70...80 °C (-94...176 °F) in 1 °C (1.8 °F) increments – set point to enable condensation and contaminants to burn off. This set point is also the temperature at which the reference image is taken and stored.

Max Depress

10...150 °C (50...302 °F) in 1 °C (1.8 °F) increments – the maximum temperature depression below Tb which can be set.

Dew-Point Type (DEWP Type)

HCdp, Wdp – Hydrocarbon dew point or Water dew point. The selection determines the type of illumination applied to the mirror surface. White light in HCdp mode enables observation of thin films of hydrocarbon condensates on the mirror surface. Red light in Wdp mode provides greatest sensitivity to observe water dew droplets and ice crystal formations.

Tip:

By changing between the two Dew-Point Type modes when observing precipitation on this mirror surface the user can determine if the dew point observed is that of pure hydrocarbon, pure water/ice or a combination of both occurring simultaneously at the same analysis pressure and mirror temperature.

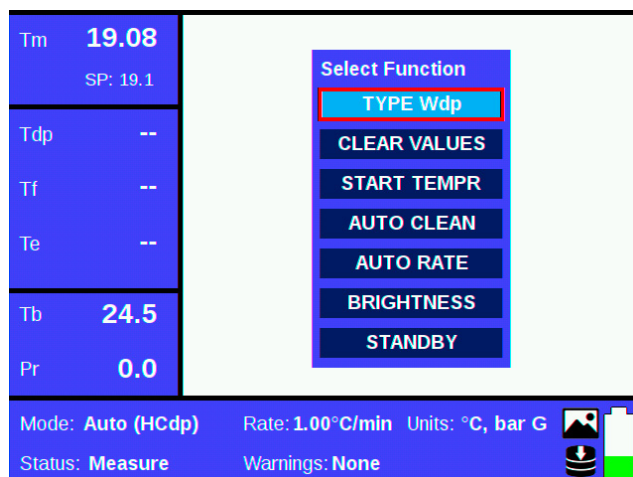
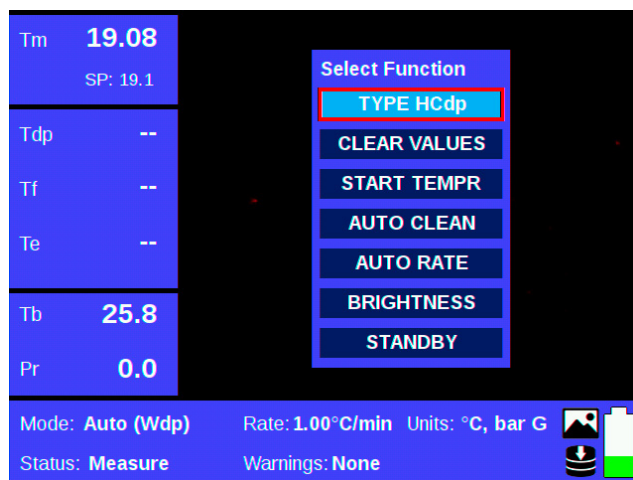
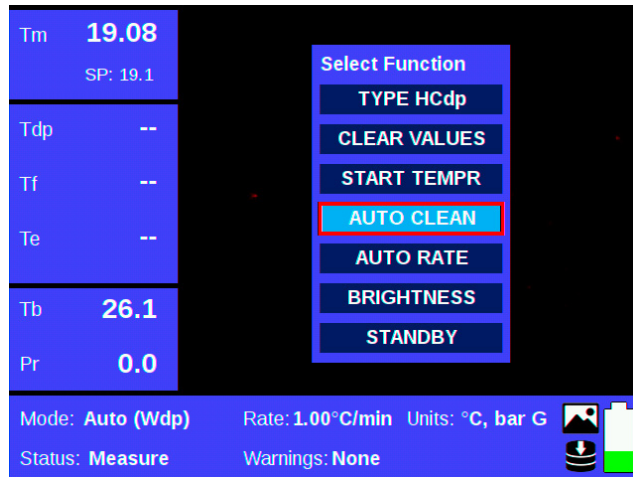

On selection of the AUTO CLEAN function, the mirror will be heated to the clean mirror temperature set point (50 °C) for the duration of 120 seconds. The mirror temperature will then settle at the enclosure temperature (STANDBY).

Cal Offset (Calibration Offset)

-10.0...+10.0 °C (+14...+50 °F)/min in 0.1 °C (0.18 °F) increments – an offset value to correct total measurement error. If the user wishes, a known dew-point gas may be used as a reference and a measurement taken. Any offset in the measurement can be noted and entered here as a fixed offset correction to subsequent measurements. CDP301 is factory calibrated and certified. The fundamental cooled-mirror measurement principle applied is inherently stable and accurate. Calibration adjustments should not be necessary. Normally Cal Offset will remain at the default value, 0.0°C.

3.2.4.2 Logging Configuration Page

Allows the user to set parameters for log data, still image and video captures.

- Enter key press – access options table
- Arrow keys press – scroll through options table
- ESC key press – exit options table

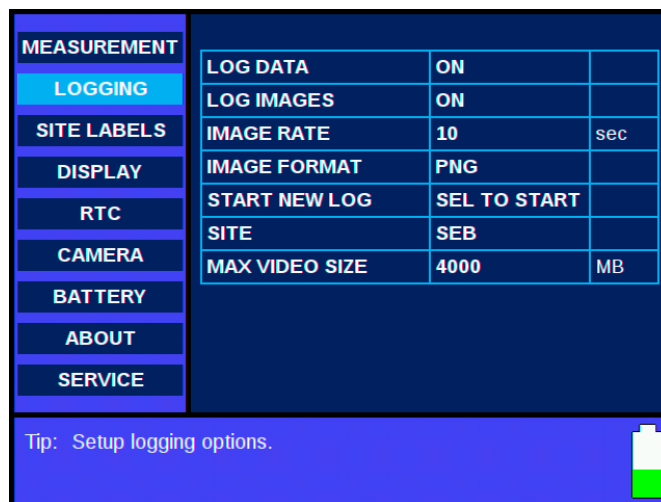

Figure 14 Configuration Menu – Logging Page

Log Data

Activates/Deactivates the acquisition of dew-point data. If Data logging is OFF, then data is not logged and images are not saved.

Log Images

Activates/Deactivates the automatic acquisition of images whilst log data is active. Images can only be automatically logged if LOG DATA as above is ON. But if LOG DATA is ON then you can choose not to save any images automatically. Does not affect manual saving of images.

Image Rate

The rate (Min 5 seconds, Max 60 seconds) at which images are taken in Auto mode

Image Format

Choice of PNG or JPEG format for saving images

Start New Log

Creates a new log data folder with new log data file (.csv). Uses this folder and file for logging images and data.

Site

Choice of user-defined (in Site Label menu) reference to the location of the measurement. This label will be logged in the log data file with each measurement.

Max video size

The maximum file size (in MB) for a single video file

3.2.4.3 Site Labels

Allows user-defined names to be allocated to any or all of the 8 available site labels.

- **ENTER** to start editing the last character
- **UP/DOWN** to change character
- **ENTER** to save character and move to next character
- **ESC** to stop editing
- Long press of **ENTER** or **ESC** will delete last character
- **ESC** will move focus away from edit box

Follow on-screen instructions for character entry and editing. Available characters are: Space, -, (,), _, 0 to 9, A to Z

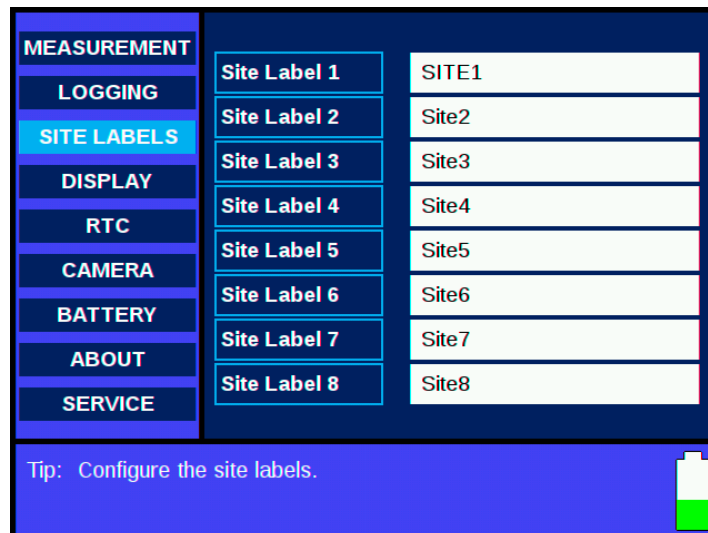

Figure 15 Configuration Menu – Site Label Page

3.2.4.4 Display

Allows the user to adjust display parameters to suit ambient light conditions.

- Enter key press – access options table
- Arrow keys press – scroll through options table
- ESC key press – exit options table

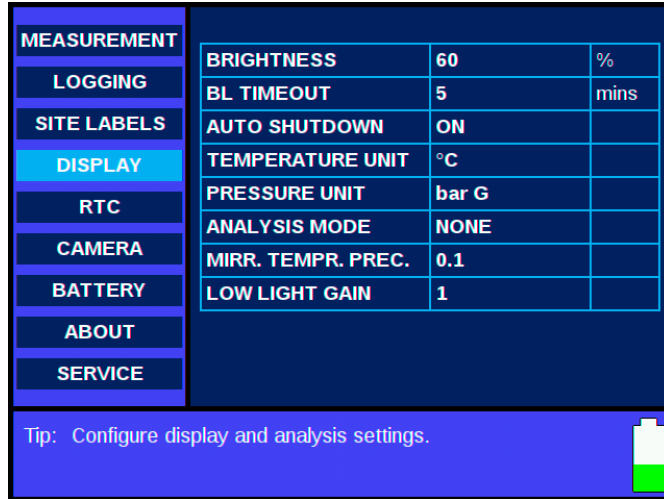

Figure 16 Configuration Menu – Display Page

Brightness

0 to 100 % – display backlight intensity

BL Timeout

1 to 30 minutes in 5-minute increments, or OFF.

Duration of time before setting the display backlight intensity to 5 % if no user input is detected. Upon user input, the backlight will revert to set BRIGHTNESS.

Auto Shutdown

On/Off – Setting this to ON will ensure that the CDP301 will automatically shut down if the battery remaining capacity level goes below 5 %. (User may override any shutdown in progress by inserting the power supply or pressing the ESC button.)

Temperature Unit

°C, °F - global temperature unit

Pressure unit

barg, PSIG, MPaG – global pressure unit

Analysis Mode (See Section 3.2.4.5 below for more details)

- None/Split Screen/Live-Ref
- Split Screen – Displays a reference image and a live image
- Live-Ref – Displays the difference between a reference image and a live image

Mirr. Tempr. Prec.

Mirror Temperature Precision: 0.1/0.01 changes the displayed temperature precision

3.2.4.5 Enhanced Analysis Modes

The CDP301 includes 3 unique forms of image enhancement to aid in easier and earlier identification of changes in the mirror. All enhancement modes utilize a reference image which is automatically stored by the CDP301 when the mirror goes through a cleaning cycle or it can be manually taken by the user from the Front Page pop-up function menu.

Live – Ref: The reference image is mathematically subtracted from the live image to produce the image viewed on the display. This usually allows changes to be apparent earlier. This is the preferred enhanced analysis for **Wdp** measurements.

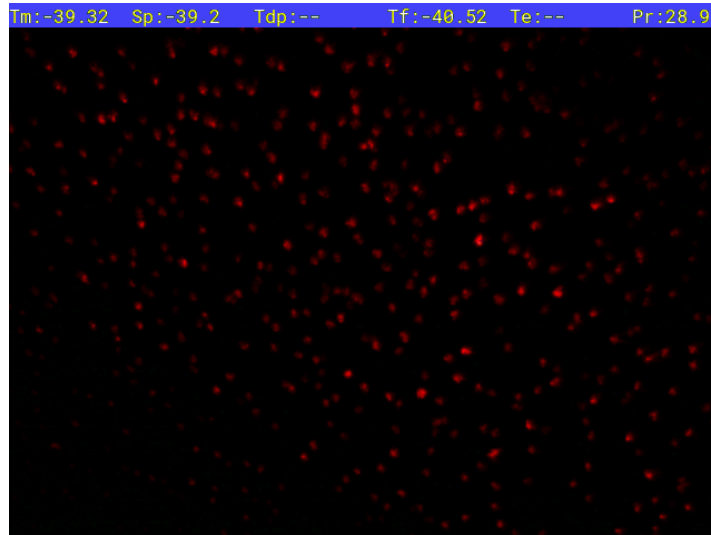

Figure 17 *Wdp Image*

Ref – Live: The live image is mathematically subtracted from the reference image to produce the image viewed on the display.

Split Screen: This enables the camera feed to be split so that the reference (static) and live images are displayed one above the other. The user can then identify changes on the live image by comparing it with the reference image. This is the preferred enhanced analysis for HCdp measurements.

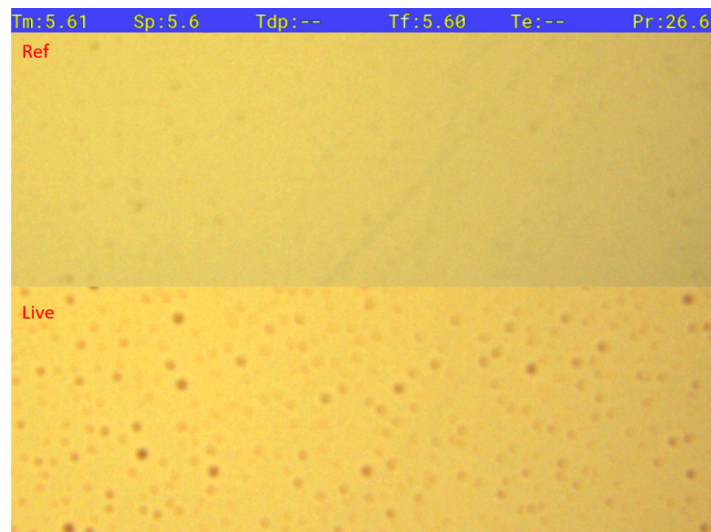

Figure 18 *Split Screen Mode*

Tip:

It is important to capture a reference image before making each measurement when using any one of the enhanced analysis modes. There are two methods to take a reference image:

a) One is taken automatically when the mirror temperature reaches the cleaning temperature set point.

b) From Front Screen B (enlarged screenshot), select 'Take Ref Image' option on the Quick Menu (**Long ENTER** key press)

3.2.4.6 Real Time Clock (RTC)

Enables the user to set up the system date/time

- Enter key press – access options table
- Arrow keys press – scroll through options table
- ESC key press – exit options table

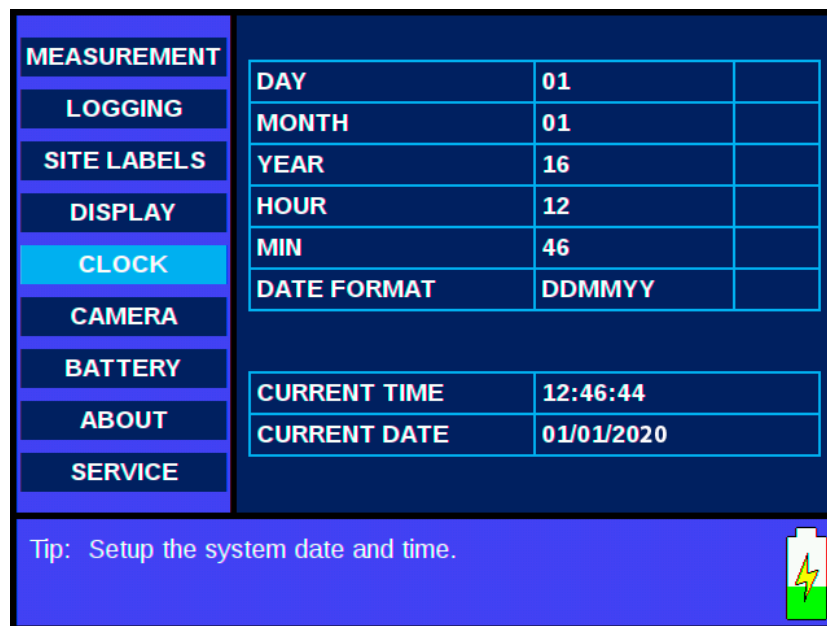

Figure 19 Configuration Menu – RTC Page

- Day:** 01 to 31 Date day
- Month:** 01 to 12 Date month
- Year:** 00 to 99 Date year
- Hour:** 00 to 23 Time hour
- Min:** 00 to 59 Time minutes
- Date Format:** DDMMYY or MMDDYY – the format for log and image timestamps

3.2.4.7 Camera Configuration

These parameters are factory set but can be adjusted if necessary.

- Enter key press – access options table
- Arrow keys press – scroll through options table
- ESC key press – exit options table

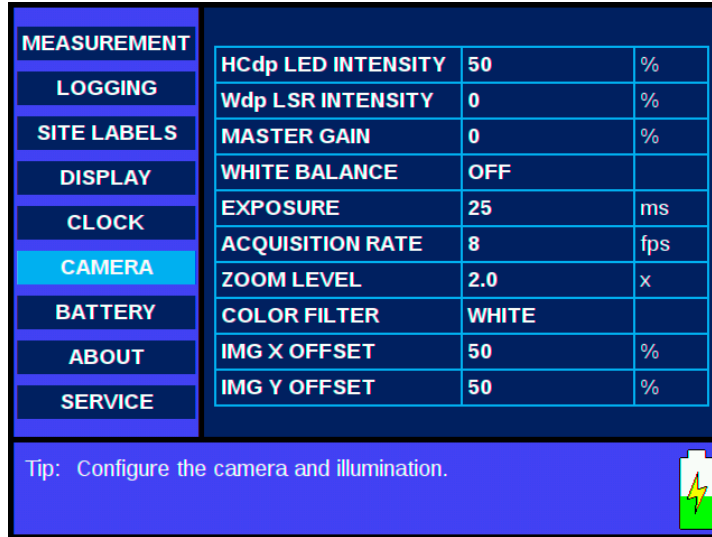

Figure 20 Configuration Menu – Camera Page

HDcp LED Intensity: 5 %...100 % in 5 % steps. (When adjusting this value, the live camera image will become visible.)

Wdp LED Intensity: 5 %...100 % in 5 % steps. (When adjusting this value, the live camera image will become visible.)

Master Gain: 0–100 % in 1 % steps or Auto – The master gain of the camera. This is essentially the amplification level of the image to increase brightness and contrast levels. An AUTO setting will attempt to adjust the amplification according to the true brightness of the image.

White Balance: On/Off – ON enables the automatic adjustment of color temperature in the camera.

Exposure: 1...220mS or Auto – Duration over which each camera frame is acquired. (When adjusting this value, the live camera image will become visible.)

Acquisition Rate: 5–18fps or Auto – Number of frames acquired from the camera every second. (When adjusting this value, the live camera image will become visible.)

Zoom Level: 1.0...4.0 in 0.5 steps – Digital zoom level of the image / size of the area of interest. (When adjusting this value, the live camera image will become visible.)

Color Filter: White/Red/Blue/Green – Only display pixels of selected RGB value. White displays all pixel colors.

Img X Offset: 0 %...100 % in 1 % steps – Adjusts horizontal location of camera display

Img Y Offset: 0 %...100 % in 1 % steps – Adjusts vertical location of camera display

3.2.4.8 Battery Status

Displays battery and system power (information only)

Capacity Remaining: 0.0...100.0 % – amount of capacity available before a recharge is required

Voltage: Range 10.0...20.0V Battery voltage level

Current: Range 0...5000mA Battery current draw (Charging current shows as positive)

Temperature: 50...100 °C (122...212 °F) Battery pack temperature

TEC Drive: Range -100 %...100 % – TEC power drive (Cooling shows as negative, heating as positive)

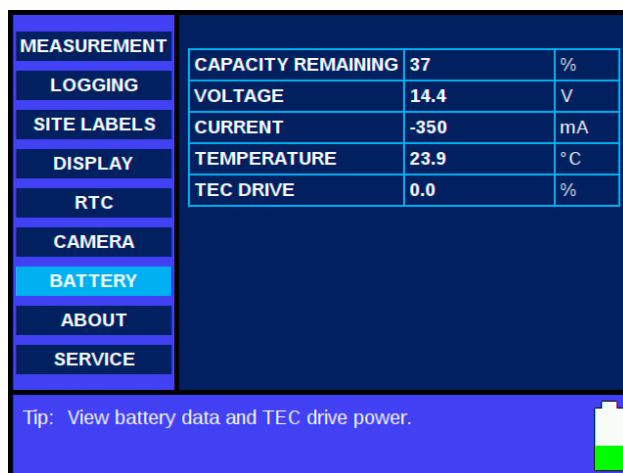

Figure 21 Configuration Menu – Battery Page

3.2.4.9 About

Control Board f/w: Firmware version

SBC F/W: Main Board Firmware Version

Serial Number: CDP301 serial number

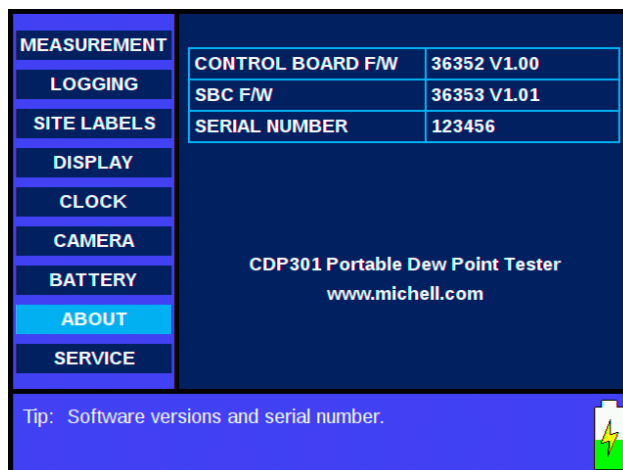

Figure 22 About Info

3.2.4.10 Service

Password protected menu, for use only under guidance from Michell Instruments Technical Support.

Set Camera Defaults: Resets all the camera settings

Set Control Board Defaults: Resets all the main board settings to the factory defaults

Reg Number: System register to Read/Write

Read Reg: Output from selected register

Write Reg: Value to write to the selected register

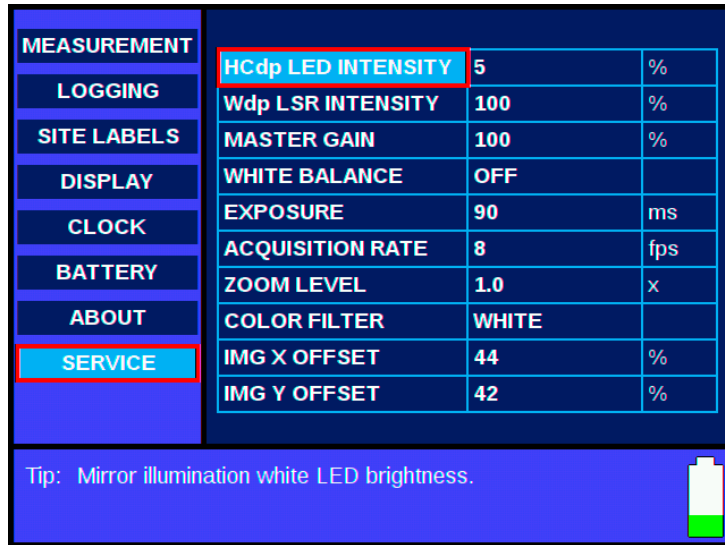

Figure 23 HCdp LED Intensity

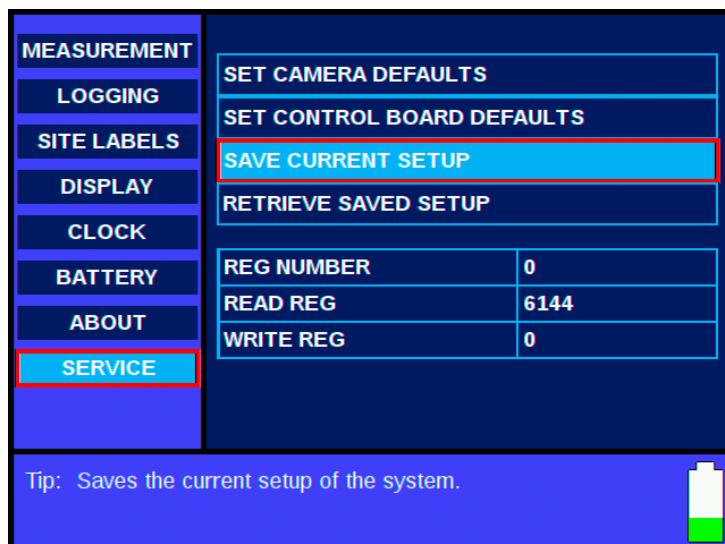

Figure 24 Save Current Setup

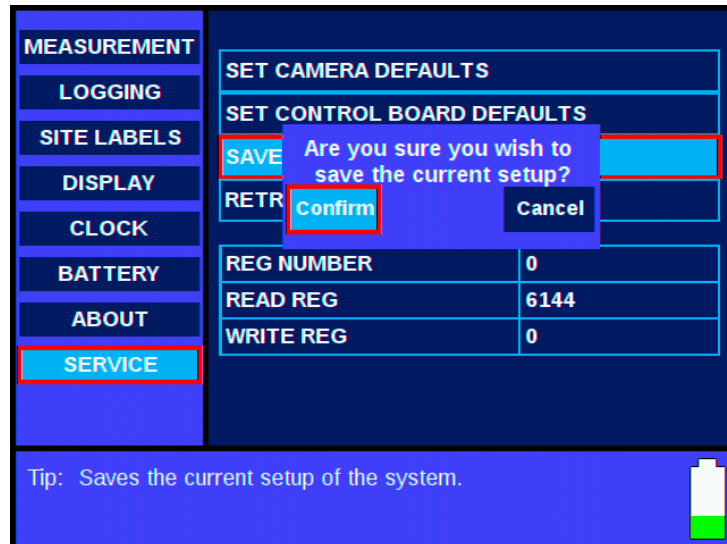

Figure 25 Save Current Setup – Confirmation

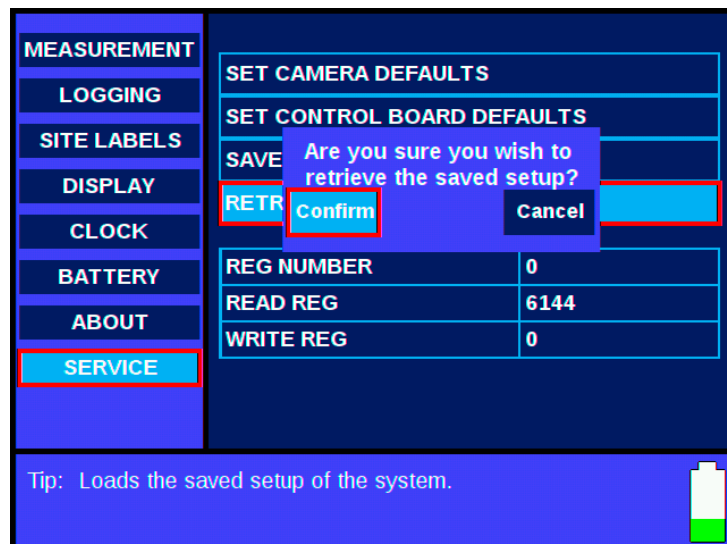

Figure 26 Retrieve Saved Setup

4 SYSTEM START-UP AND MEASUREMENT PROCEDURE

This procedure must be carried out on initial start-up and at any time following service or maintenance periods.

Proceed as follows:

1. Check all CDP301 gas inlet and outlet connections for leak tightness
2. Ensure pressure and flow is at zero
3. Switch on the CDP301
4. Adjust sample pressure to required values
5. Set sample flow – 0.5 NI/m (0.03 Nm³/hr)
6. CDP301 is now ready to use

4.1 Taking a measurement

The actual detailed process of taking a dew-point measurement using the CDP301 will vary depending on local regulations and conditions such as weather, temperature, sample tapping location and many others. The following is a basic method of carrying out a measurement and assumes that the CDP301 Dew-Point Tester:

- Is properly mounted and secured
- Is correctly connected to the sample tapping point and vent lines
- Has enough battery charge for the length of time required for the measurements to be taken. A full charge will last up to 8 hours.

Tips:

Set the display to an adequate brightness for the conditions. For instance, a display brightness setting of around 30 % is suitable for indoor use under internal lighting.

If the expected dew-point temperature is known, set the start temperature to about 10 °C (18 °F) warmer than the expected dew point. If it isn't known, set this temperature to the ambient temperature.

4.1.1 User Interface Controls

In all menus, navigate by pressing:

- **ENTER** to select item to change
- **UP/DOWN** arrows to scroll or change value
- **ENTER** inside a menu to deselect and save change
- **ESC** to exit.

Some functions have **Long** or **Short** presses for different actions in the menu.

4.1.2 Display Meanings

Tm = Current Mirror Temperature

SP = Current mirror Set point temperature

Tdp = Calculated dew-point temperature (calculated average of **Tf** and **Te**)

Tf = Formation temperature – the user-determined mirror temperature of dew formation

Te = Evaporation temperature – the user-determined mirror temperature of dew evaporation

Tb = Body temperature

Pr = Sensor cell gas pressure

4.1.3 Recording or Capturing an Image

To record the process or capture the image from the Full Screen view, press **Long Enter**, then select from Quick Menu.

A red circle will flash at the top right of the display to indicate that a video is being recorded.

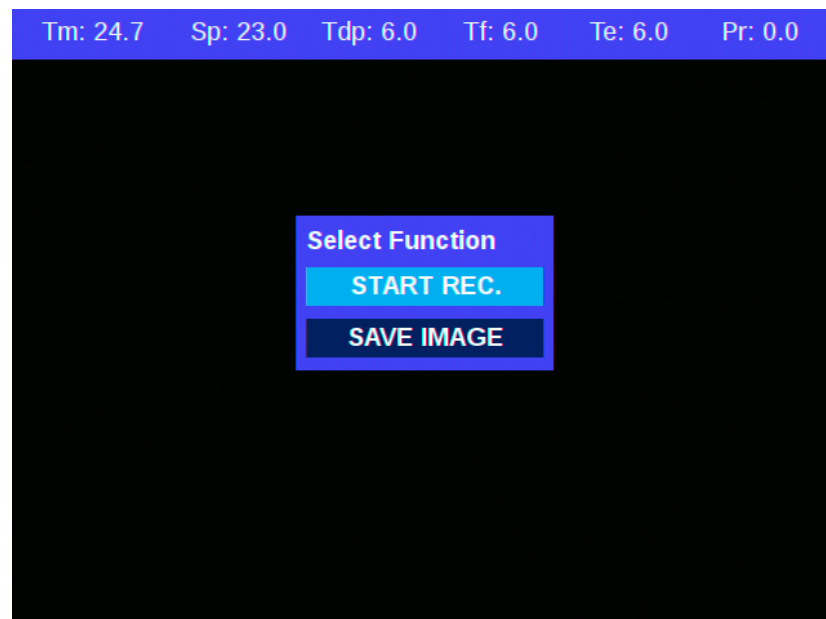

Figure 27 *Image Capture / Recording*

4.1.4 Step-By-Step Measurement Guide

1. On start-up, the following display will appear. Use **Long ESC** to select the Configuration Menu.

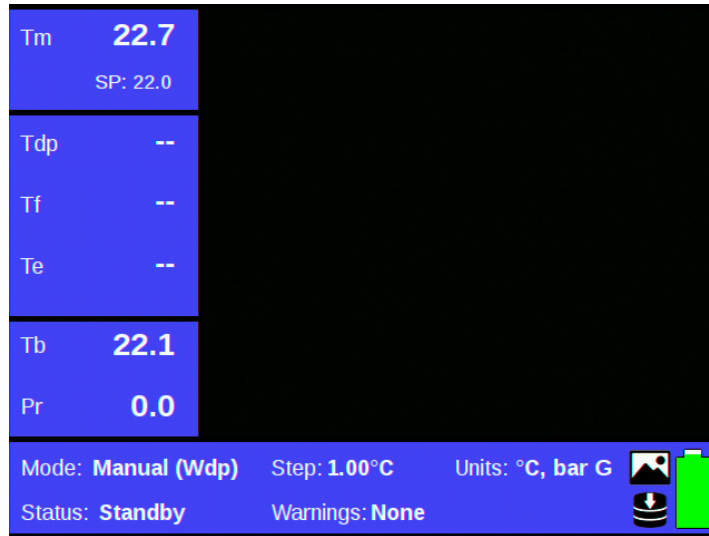

Figure 28 Front Page A

2. Set the instrument to Manual Mode and press **Short Enter** to select the Measurement Menu. Using the **Arrow** keys to scroll, set the dew-point type (HCdp or Wdp). Press **ESC, ESC** to exit.

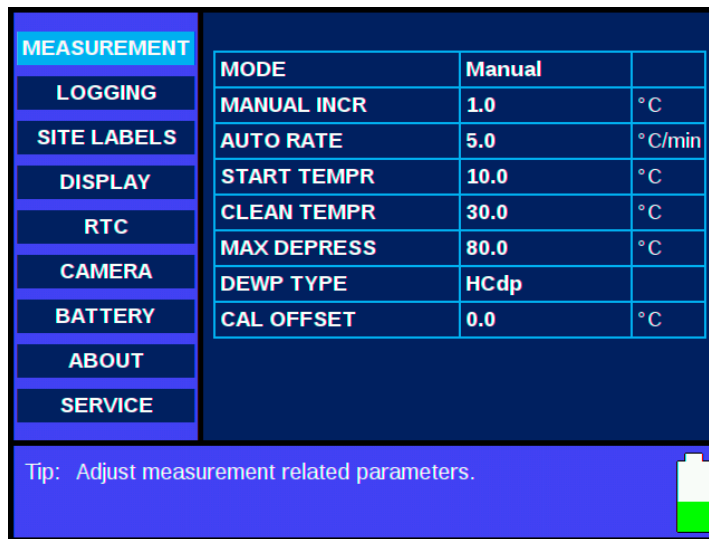

Figure 29 Measurement Menu

- From Front Page A, open Quick Menu. Press **Long Enter**.
 Scroll down (**Down Arrow**) to Clean Tempr, press **Short Enter** and leave for 2 minutes (or until the mirror is clean).

Note: A reference image is automatically taken once the mirror reaches the cleaning set point.

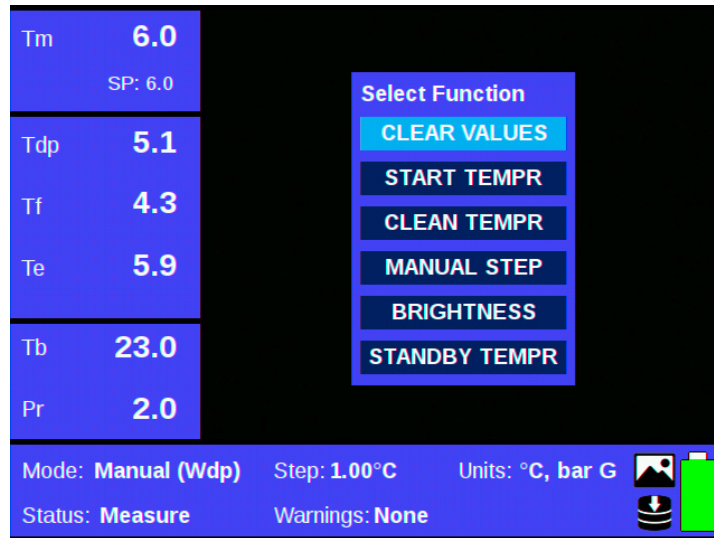

Figure 30 Quick Menu

- Scroll to Start Tempr using the arrow keys, press **Short Enter** and wait until stabilized.
- If using a comparison mode (recommendations are split screen for HCdp or live-ref for Wdp), select the Configuration Menu: **Long ESC**.

Scroll down (**Down Arrow**) to Display, press **Short Enter**, scroll to Analysis Mode, press **Short Enter**, scroll to select Split Screen or Live-Ref, then press **Short Enter**

To exit press **ESC, ESC**.

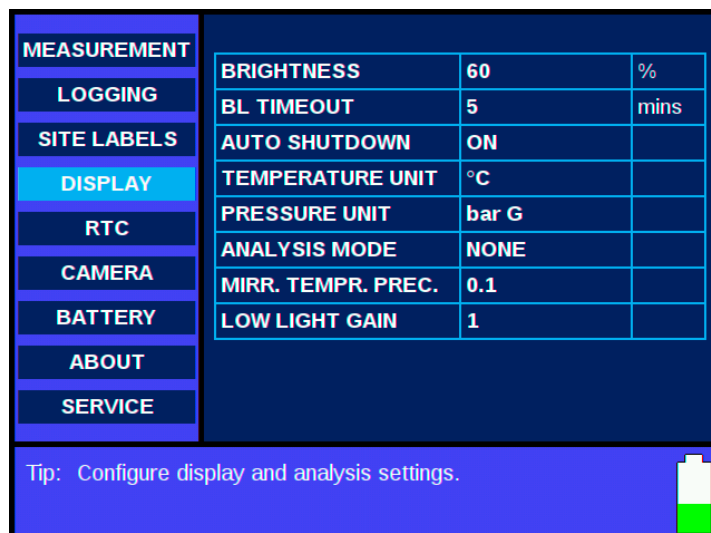

Figure 31 Configuration Menu – Display Page

6. From Front Page A, open Quick Menu. Press **Long Enter**.

Scroll down (**Down Arrow**) to Manual Step, press **Short Enter** and set the temperature to 5 °C (41 °F).

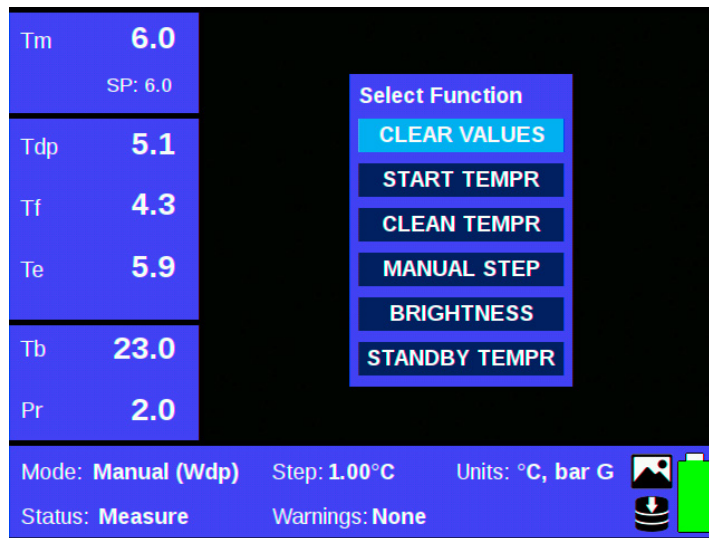

Figure 32 Quick Menu

7. Reduce the mirror temperature in 5 °C (9 °F) steps. Press the **Down Arrow** (wait 20 seconds for the mirror temperature to reach the setpoint between steps) until a visible change in the image has occurred.

Increase the mirror temperature in 5 °C steps (9 °F). Press the **Up Arrow** (again wait 20 seconds until the mirror temperature has reached its setpoint between steps) until the visible dew has disappeared.

8. In manual mode set the step size to 1 °C (1.8 °F).

From Front Page A, open Quick Menu (see Figure 32). Press **Long Enter**.

Scroll down (**Down Arrow**) to Start Tempr, press **Short Enter** and set to previous Te value. Press **Short ESC**.

Scroll down (**Down Arrow**) to Manual Step, press **Short Enter** and set to 1 °C (1.8 °F).

Repeat Step 7 with 1 °C (1.8 °F) steps.

9. Select Configuration Menu with **Long ESC**.

Select Measurement and press **Short Enter**; select Mode then press **Short Enter**; select Auto.

Set the instrument to auto mode with a 0.5 °C (0.9 °F)/min ramp rate. Press **Short Enter**, then use the arrow keys to scroll. Press **Short ESC** to exit.

Set 0.5 °C (0.9 °F)/min ramp rate. This is the ASTM D1142/ISO6327 standard ramp rate. Press **Short ESC, ESC** to exit to Front Page A.

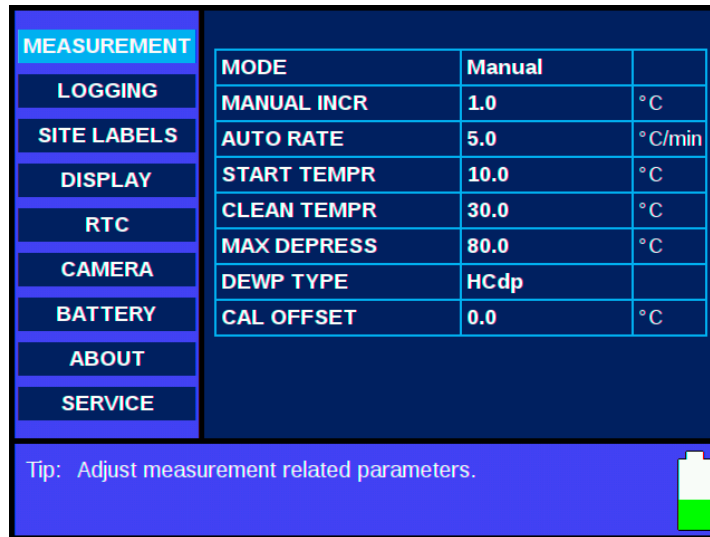

Figure 33 Configuration Menu – Measurement Page

- From Front Page A, go to Front Page B (Full Screen view) with **Short ESC**. This displays the Split Screen (HCDP) mode.

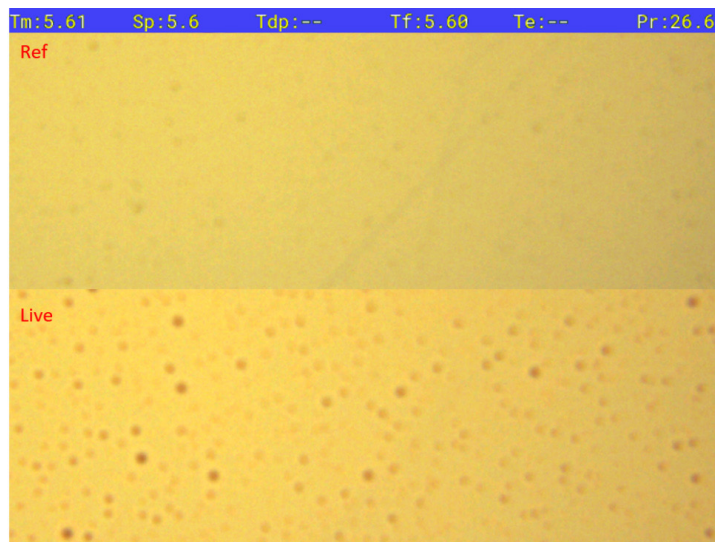

Figure 34 Split Screen (HCDP) mode

- Set the temperature to reducing by scrolling down (**Down Arrow**) and record the temperature at first signs of dew forming by pressing the **Down Arrow** then **Short Enter**.

Set the temperature to increasing by scrolling up (**Up Arrow**) and record the temperature when the Live image returns to the same appearance as the Ref image by pressing the **Up Arrow** then **Short Enter**.

- The dew point is automatically calculated as the average of the forming and evaporation temperatures, as per the standards.

NOTE: Should the user have any doubt about the form of condensation observed for a particular measured dew-point temperature, repeating the measurement after changing the Dew-Point Type setting to the alternative mode (HCdp or Wdp) can be used to confirm the form of dew point being observed.

4.2 System Shut-Down Procedure

This procedure must be carried out prior to carrying out any maintenance or servicing.

Proceed as follows:

1. Press and hold the Power button; the CDP301 will go through a quick heating cycle to clean the mirror before shutdown.
2. CLOSE the Sample Isolation Valve to shut off the sample gas supply to the system.
3. Allow the system to vent and depressurize.

NOTE: If for any reason there is a software 'lock up' with the instrument still powered on, it is possible to carry out a reset. To do this reset, depress and hold the four navigate and select buttons simultaneously (not the power button).

4.3 Battery Replacement

Procedure for changing the battery in the CDP301:

Warning: This work should only be carried out in a non-hazardous (safe) area.

1. Ensure the CDP301 is turned off.
2. Place the CDP301 display downwards on a solid, flat surface.
3. Unscrew base of the CDP301.
4. Unplug the battery from the CDP301.
5. Slide the old battery out from the CDP301.
6. Reverse steps 3, 4 and 5 to insert the new battery.

4.4 Battery Charging (within the dew-point tester)

NOTE: This procedure allows the charging of the battery whilst still inserted in the CDP301.

Warning: This work should only be carried out in a non-hazardous (safe) area.

1. Ensure the CDP301 is turned off.
2. Place the CDP301 on the holding cradle or a solid, flat surface
3. Loosen the 2 Hexagonal head (2.5mm Allen key) captive screws from the charge socket cover on the keypad. Remove the charger port cover.



Figure 35 *Remove Charger Cover*

4. Connect the power supply adaptor (Michell part number CDP301-PS) to the CDP301.
5. Turn the mains supply on. A blue LED indicates that charging is taking place when the CDP301 is turned off. This LED is located above the LC display in the fascia.
6. Turn on the power on the CDP301 to access the data on the instrument, if required during charging. The battery power capacity icon will indicate charge status.



Figure 36 *Connect Charger Lead*

4.5 Spare Battery Charging

A spare battery can be charged away from the instrument using the optional battery charger (CDP301-CH).

Warning: This work should only be carried out in a non-hazardous (safe) area.



Figure 37 *Spare Battery Charging*

4.6 Data Access

Below is the procedure for downloading saved logs, images and/or video files from the CDP301.

Warning: This work should only be carried out in a non-hazardous (safe) area.

1. Ensure the CDP301 is turned on.
2. Place the CDP301 display downwards on a solid, flat surface.
3. Unscrew the base of the CDP301.
4. Attach a USB B connector to the CDP301 USB Port (See Figure 38, USB Port) and the other end to a laptop or PC.
5. The CDP301 will be detected and can be accessed as an external mass storage device.
6. Copy or cut and paste the required files onto the laptop or PC.

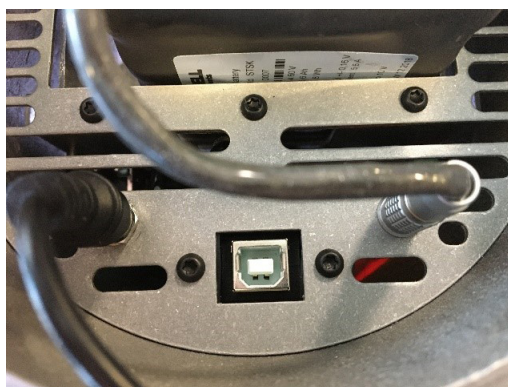

Figure 38 *USB Port*

5 MAINTENANCE



**System operates under high pressure!
Isolate and depressurise the sampling system before
attempting any maintenance or servicing**

Routine maintenance of the CDP301 is confined to regular filter replacement and mirror cleaning. We would also recommend that periodic pressure leak testing is carried out on sample system components, especially if they are being transported with the CDP301 system.

5.1 Calibration

Each CDP301 is factory calibrated by measurements of high-purity ethane vapour. The condensation temperature with variation in pressure of ethane is well defined, enabling the correct operation of the cooled-mirror sensor to be determined. The rapid condensation rate of this single component calibration gas, with virtually instantaneous precipitation onto the mirror surface at the dew-point temperature, enables the +/- 0.5°C (0.9 °F) accuracy specification of the CDP301 to be confirmed and certified.

Annual re-calibration of the CDP301 is recommended. This service is available throughout the global network of Michell Instruments Sales and Service Centers and authorized service partners. Alternatively, a user may themselves validate the measurement performance of the CDP301 by performing a series of measurements of a defined test gas. High-purity (99.5 %, preferably 99.9 %) ethane or n-propane can fulfil this requirement and for which Michell Instruments will be pleased to provide tables indicating HC dew-point temperature over a range of test pressures.

5.2 Filter Element Replacement

Life expectancy of the filter element is dependent upon operating conditions in each specific application. As a minimum, it is recommended that the filter element be replaced every 12 months. If inspection of the removed element shows that it is in poor condition, then the operating period between replacements can be reduced accordingly.

If the CDP301 has a Michell-supplied sample system, the filter element is part of that system supplied and is easily accessible.

5.3 Mirror Cleaning

Due to contamination in the natural gas, periodic cleaning of the CDP301 mirror may be required. This must be carried out in a safe area only, in a clean environment. The cleaning kit supplied contains laboratory cotton buds and a container for cleaning solvent. Please note that the container is supplied empty due to shipping regulations. Laboratory-grade Isopropyl alcohol is required for mirror cleaning.

It is recommended that the user also carries the following items:

- DSLR camera sensor air blower
- Magnifying eyeglass (at least 3x magnification)
- A small battery-powered torch
- Long-reach 3mm and 4mm Allen keys



Figure 39 *Cleaning Accessories*

5.3.1 CDP301 Preparation

- Ensure that the instrument is powered down and the charging port is not connected.
- Remove all gas pressure from the instrument.
- Disconnect all external gas tubing to the flame arrestors

5.3.2 Opening Measurement Cell

- Using the handles supplied, open the lid of the CDP301 and set aside.



Figure 40 *Lid Removal*

- Using the 3mm Allen key, loosen the retaining screw on the right of the display (the screw is captive so will not come completely out of the bracket), then carefully fold the display module from the right side and rest it on the instrument case.

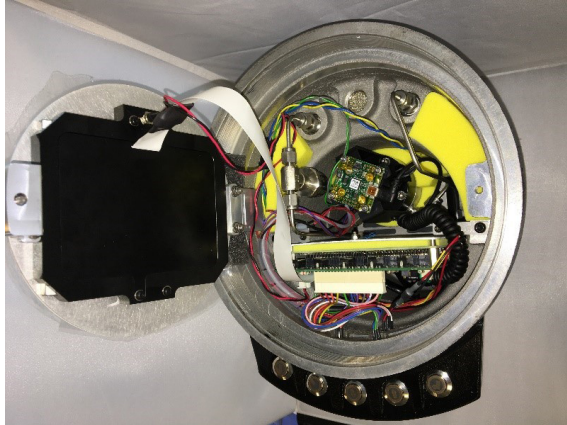

Figure 41 *Display Opened*

- Gently unplug the USB cable from the camera (see Figure 42, Camera USB connection).
- Using a long 4mm Allen key, undo the 4 screws securing the camera assembly and lift off. If necessary, break the cell sensor connections at the in-line connector (see Figure 43, Camera sensor in-line connector). Place the assembly upside down on a flat surface to protect the window surface.

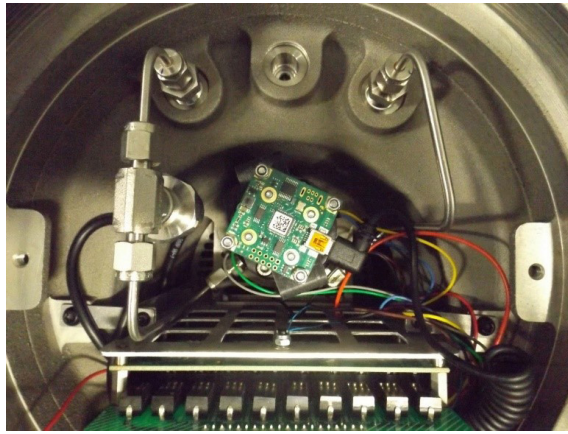

Figure 42 *Camera USB Connection*

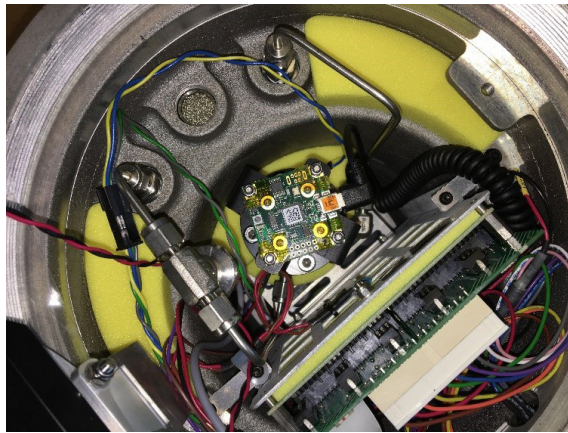

Figure 43 *Camera Sensor In-line Connector*

5.3.3 Removing Particulates

- Use the air blower to remove particulates from the inside of the measurement cell. Pay particular attention to the mirror surface (see Figure 44, Checking the mirror surface) and surroundings.
- Inspect the inside of the cell using the eyeglass and torch to confirm that all particulates have been removed.



Figure 44 *Checking the Mirror Surface*

5.3.4 Removing Residue

- Coat a cotton bud in IPA and shake off any excess.
- Use the cotton bud to clean the mirror surface from the center to the outside with a rotating motion.
- Allow the surface to dry and check for any remaining residue using the eyeglass and torch.
- Repeat cleaning until all residue has been removed. The mirror should now be a uniform color.
- Repeat the cleaning process for the camera window surface.



Figure 45 Camera Assembly

5.3.5 Reassemble Sample Cell

- Replace the camera assembly onto the cell base assembly.
- Tighten the camera assembly screws in a star pattern (see Figure 46, Screw Tightening Order).
 - Initially tighten the screws to the point where the camera assembly starts to compress the sample cell O-ring.
 - Tighten the screws in $\frac{1}{4}$ -turn steps, progressing around the star pattern until all screws are fully tightened.
- Carefully reattach the camera USB cable.
- Using the hinge mechanism, carefully replace the display and secure using the captive screw.
- Replace and secure the CDP301 lid.

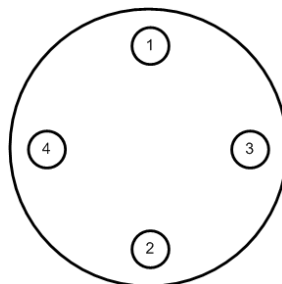

Figure 46 Screw Tightening Order

5.3.6 Check Mirror Cleanliness

- Turn the CDP301 on and allow to boot up.
- Turn the CDP301 to Dew-Point Type HCdp measurement and check that the mirror surface is a uniform color.
- Turn the CDP301 to Dew-Point Type Wdp measurement and check that all particulates have been removed from the mirror surface.
- If the mirror surface is not suitably clean repeat this process.

NOTE: A gas pressure test and appropriate leak check should be carried out in accordance with local site regulations before the product is used.

Appendix A

Technical Specifications

Appendix A Technical Specifications

Hydrocarbon & Water Dew-Point Measurement	
Measurement Technique	Chilled Mirror
Sensor Cooling	Automated cooling ramp rate selectable according to ASTM D1142 or ISO6327 measurement practice
Maximum Range	Depression range $\Delta T > 65\text{ }^{\circ}\text{C}$ (149 $^{\circ}\text{F}$) up to 100 barg (1450 psig) cell pressure
Accuracy	$\pm 0.5\text{ }^{\circ}\text{C}$ (0.9 $^{\circ}\text{F}$)
Resolution	0.1 $^{\circ}\text{C}$, 0.1 $^{\circ}\text{F}$
Sample Flow	0.25...0.5 NI/min (0.5...1 scfh)
Pressure Measurements HCdp & Wdp	
Units	MPa, barg, psig
Resolution	0.1 MPa, 0.1 barg, 1 psig
Accuracy	+/- 0.25 % FS
Dew-Point Tester	
Operating Pressure	Up to 100 barg (1450 psig)
Sample Supply Pressure	20...100 barg (290...1450 psig)
Enclosure	Cast LM25 aluminium, IP64 Exd
Gas Wetted Parts	316SS
Process Connection	1/4" NPT
Weight	8 kg (17.6 lb) (without accessories)
Operating Environment	-30 $^{\circ}\text{C}$ *...+50 $^{\circ}\text{C}$ (-22 $^{\circ}\text{F}$...+122 $^{\circ}\text{F}$) max 95 %rh
Display & User Interface	High-definition 5" full-color display, operated by 5 push buttons
Power Supply	Rechargeable Li-ion battery, up to 8 hours life from full charge
Hazardous Area Certification	See Appendix B
Data transfer	USB Standard B connector for log/image transfer (safe area only)
Mounting	5/8" – 11 UNC fitting suitable for Tripod mount Optional benchtop mount available

* Check unit marking label for correct safe operating temperatures

A.1 Dimensions

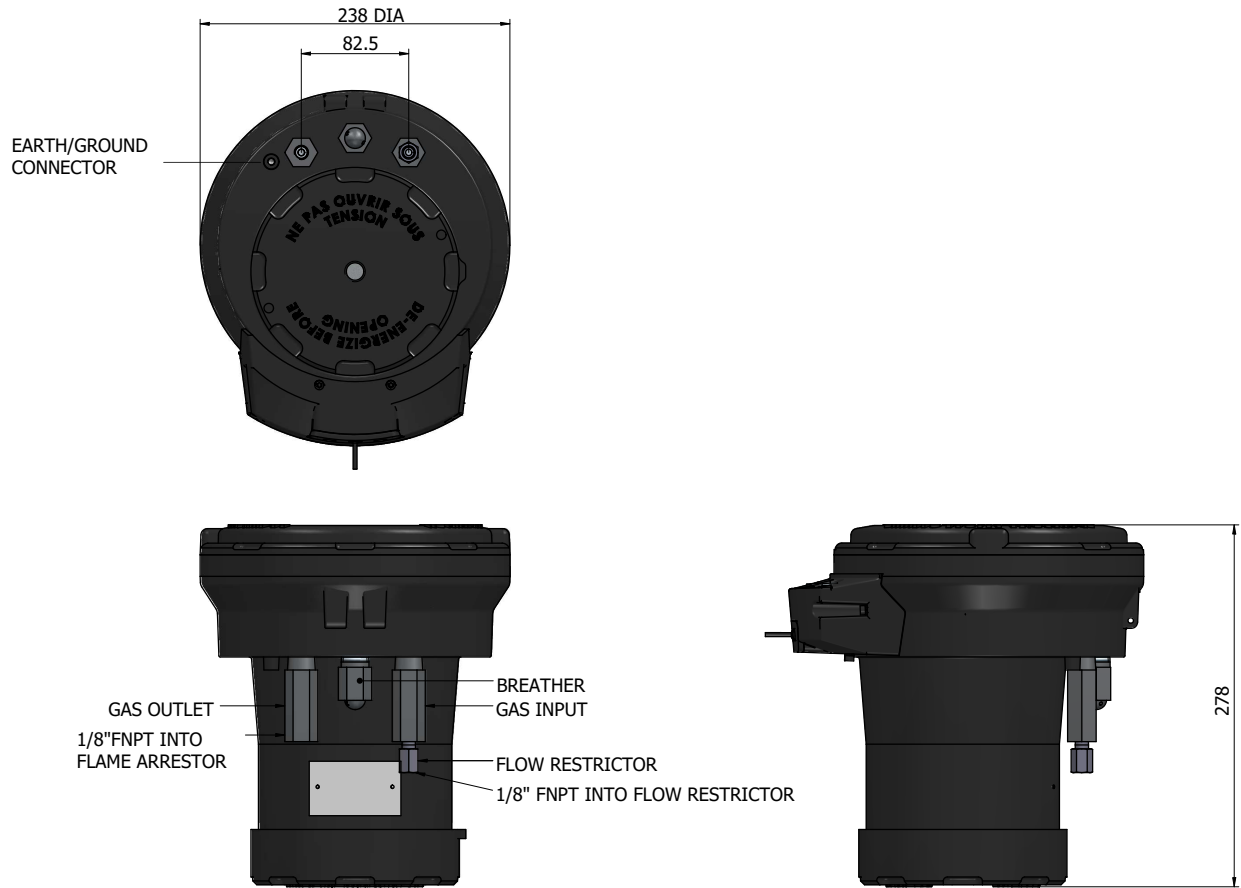

Appendix B

Hazardous Area Certification

Appendix B Hazardous Area Certification

The CDP301 Dew-Point Tester is certified compliant to the ATEX Directive (2014/34/EU), the IECEx scheme and SI 2016 No. 1107 UKCA product marking scheme for use within Zone 1 & 2 Hazardous Areas and has been assessed as being so by CML BV Netherlands (Notified Body 2776) and EUROFINs CML UK (Approved Body 2503).

The CDP301 Dew-Point Tester is certified compliant to the applicable North American Standards (USA and Canada) for use within Class I, Division 1 and Class I, Zone 1 Hazardous Locations and has been assessed as being so by QPS Evaluation Services Inc.

B.1 ATEX/UKCA

Certificate: CML 19ATEX1373X / CML 21UKEX1046X

Certification: II 2 G Ex db ia IIB+H2 T3 Gb
Tamb -30 °C...+50 °C

Standards: EN IEC 60079-0:2018, EN 60079-1:2014, EN 60079-11:2012

B.2 IECEx

Certificate: IECEx CML 19.0115X

Certification: Ex db ia IIB+H2 T3 Gb
Tamb -30 °C...+50 °C

Standards: IEC 60079-0:2017, IEC 60079-1:2014, IEC 60079-11:2011

B.3 North American (cQPSus)

Certificate: LR1507-2R1

Certification: Class I, Division 1, Groups B, C & D T3
Tamb -25 °C...+50 °C
Class I, Zone 1
AEx db ia IIB+H2 T3 Gb / Ex db ia IIB+H2 T3 Gb
Tamb -30 °C...+50 °C

Standards: UL 60079-0-7th ed. / CSA C22.2 No. 60079-0:19
UL 60079-1-7th ed. / CSA C22.2 No. 60079-1:16
UL 60079-11-6th ed. / CSA C22.2 No. 60079-11:14
UL 61010-1-3rd ed. / C22.2 No. 61010-1:12
FM 3600-2018, FM 3610-2018, FM 3615-2018
CSA C22.2 No. 30:1986

These certificates can be viewed or downloaded from our website at: www.ProcessSensing.com

B.4 Special Conditions of Use

The following conditions relate to safe installation and/or use of the equipment:

1. The flamepath dimensions differ from the requirements of EN/IEC 60079-1, therefore they shall not be repaired by the end user. Contact the manufacturer for more information.
2. The CPD301 Dew Point Tester shall not be opened or charged in the hazardous area.
3. The equipment is a potential electrostatic charging hazard, therefore, shall only be cleaned with a damp cloth.
4. The flameproof joints of the KILLARK KBQA breather are not intended to be repaired.

Appendix C

Quality, Recycling & Warranty Information

Appendix C Quality, Recycling, Compliance & Warranty Information

Michell Instruments is dedicated to complying to all relevant legislation and directives. Full information can be found on our website at:

www.ProcessSensing.com/en-us/compliance

This page contains information on the following directives:

- Anti-Facilitation of Tax Evasion Policy
- ATEX Directive
- Calibration Facilities
- Conflict Minerals
- FCC Statement
- Manufacturing Quality
- Modern Slavery Statement
- Pressure Equipment Directive
- REACH
- RoHS3
- WEEE2
- Recycling Policy
- Warranty and Returns

This information is also available in PDF format.

Appendix D

Return Document & Decontamination Declaration

Appendix D Analyzer Return Document & Decontamination Declaration

Decontamination Certificate

IMPORTANT NOTE: Please complete this form prior to this instrument, or any components, leaving your site and being returned to us, or, where applicable, prior to any work being carried out by a Michell engineer at your site.

Instrument			Serial Number	
Warranty Repair?	YES	NO	Original PO #	
Company Name			Contact Name	
Address				
Telephone #			E-mail address	
Reason for Return /Description of Fault:				
Has this equipment been exposed (internally or externally) to any of the following? Please circle (YES/NO) as applicable and provide details below				
Biohazards			YES	NO
Biological agents			YES	NO
Hazardous chemicals			YES	NO
Radioactive substances			YES	NO
Other hazards			YES	NO
Please provide details of any hazardous materials used with this equipment as indicated above (use continuation sheet if necessary)				
Your method of cleaning/decontamination				
Has the equipment been cleaned and decontaminated?			YES	NOT NECESSARY
Michell Instruments will not accept instruments that have been exposed to toxins, radio-activity or bio-hazardous materials. For most applications involving solvents, acidic, basic, flammable or toxic gases a simple purge with dry gas (dew point <-30°C) over 24 hours should be sufficient to decontaminate the unit prior to return. Work will not be carried out on any unit that does not have a completed decontamination declaration.				
Decontamination Declaration				
I declare that the information above is true and complete to the best of my knowledge, and it is safe for Michell personnel to service or repair the returned instrument.				
Name (Print)			Position	
Signature			Date	



NOTES



Instrument Expert
Original factory
packaging
www.dorgean.com



www.ProcessSensing.com