



ADG400

Advanced Dew-Point Generator

User Manual



99998 Issue 1
November 2022

Please fill out the form(s) below for each instrument that has been purchased.

Use this information when contacting Michell Instruments for service purposes.

Product Name	
Order Code	
Serial Number	
Invoice Date	
Installation Location	
Tag Number	

Product Name	
Order Code	
Serial Number	
Invoice Date	
Installation Location	
Tag Number	

Product Name	
Order Code	
Serial Number	
Invoice Date	
Installation Location	
Tag Number	



ADG400

For Michell Instruments' contact information please go to
www.michell.com

© 2022 Michell Instruments

This document is the property of Michell Instruments Ltd and may not be copied or otherwise reproduced, communicated in any way to third parties, nor stored in any Data Processing System without the express written authorization of Michell Instruments Ltd.

Contents

Safety	vi
Electrical Safety	vii
Pressure Safety	vii
Hazardous Materials (WEEE, RoHS3 & REACH)	vii
Safe Handling	vii
Repair and Maintenance	vii
Safety Conformity	vii
Abbreviations	viii
1 INTRODUCTION	1
1.1 Features	1
1.2 Theory of Operation	2
2 INSTALLATION	3
2.1 Unpacking the Instrument.....	3
2.2 Power Supply	3
2.3 USB Connection.....	3
2.4 Dry Gas Supply	3
2.5 Gas Connections.....	4
2.6 Typical Setup	4
3 OPERATION	5
3.1 First-time Operation.....	5
3.2 Typical Calibration Run	5
3.3 HMI.....	6
3.4 Screensaver	6
3.5 Main Screen	7
3.6 Modes of Operation	8
3.6.1 Manual Mode	8
3.6.1.1 Set Point Picker.....	9
3.6.2 Profile Mode	9
3.6.3 Remote Mode	10
3.6.3.1 Remote Mode Commands.....	11
3.6.4 Remote Access	12
3.6.5 Installing and Using the Remote Access Software.....	12
3.6.6 Status Page	13
3.6.6.1 Transition Delay	14
3.6.7 Settings Menu.....	14
3.6.8 Set Point Editor.....	15
3.6.8.1 Converting MFC Values to ml/min Flow Rates.....	16
3.6.8.2 Adjusting Set Points	16
3.6.9 Profile Editor.....	17
3.6.10 Saturator Filling Mode	18
3.6.10.1 Saturator Filling Instructions	19
4 MAINTENANCE	20
4.1 Inlet Particulate Filter	20
4.2 Fuses	20
4.3 General Troubleshooting	21
4.4 Emptying the Saturators for Transport.....	22

Tables

Table 1	Minimum Stabilization Times	6
Table 3	Read Command Response Explanation	11
Table 2	Supported Serial Commands	11
Table 4	Span of Installed MFCs	16

Figures

Figure 1	Typical Setup Diagram	4
Figure 2	Manual Mode	7
Figure 3	Profile Mode.....	7
Figure 4	Main Screen in Manual Mode.....	8
Figure 5	Set Point Picker Screen	9
Figure 6	Main Screen in Profile Mode	9
Figure 7	Profile Selection Screen.....	10
Figure 8	Main Screen in Remote Mode	10
Figure 9	Main Screen Shown on a PC via Remote Access Software.....	12
Figure 10	Status Page Screen.....	13
Figure 11	Settings Screen	14
Figure 12	Set Point Editor Screen	15
Figure 13	Profile Editor Screen	17
Figure 14	Saturator Filling Screen.....	18
Figure 15	Saturator Fill Levels	18
Figure 16	ADG400 with Open Front Panel	19
Figure 17	ADG400 Internal View	22

Appendices

Appendix A	Technical Specifications.....	24
	A.1 Dimensions	25
Appendix B	Quality, Recycling, Compliance & Warranty Information.....	27
Appendix C	Return Document & Decontamination Declaration.....	29

Safety

The instrument is designed to be completely safe when installed and operated correctly in accordance with the information provided in this manual.

This manual contains all the required information to install, operate and maintain this product. Prior to installation and use of this product, this entire manual should be read and understood. Installation and operation of this product should be carried out by suitably competent personnel only. The installation and operation of this product must be in accordance with the instructions provided and according to the terms of any associated safety certificates. Incorrect installation and use of this product other than those described in this manual and other than its intended purpose will render all warranties void.

This product meets the essential protection requirements of the relevant EU & UK directives. Further details of applied directives may be found in the product specification.

Electricity and pressurized gas can be dangerous. This product must be installed and operated only by suitable trained personnel.



No user serviceable parts inside



Where this hazard warning symbol appears in the following sections, it is used to indicate areas where potentially hazardous operations need to be carried out and where particular attention to personal and personnel safety must be observed.



Where this symbol appears in the following sections it is used to indicate areas of potential risk of electric shock.

This product is intended for use only under the following conditions:

- a. indoor use
- b. altitude up to 2,000 m
- c. temperature 5 °C...40 °C
(refer to Appendix A, Technical Specification, for Operating Temperature range)
- d. maximum relative humidity 80 % for temperatures up to 31 °C decreasing linearly to 50 %, relative humidity at 40 °C
- e. MAINS supply voltage fluctuations up to ± 10 % of the nominal voltage
- f. TRANSIENT OVERVOLTAGES up to the levels of OVERVOLTAGE CATEGORY II
- g. TEMPORARY OVERVOLTAGES occurring on the MAINS supply
- h. applicable POLLUTION DEGREE 2 of the intended environment

Electrical Safety

Ensure electrical safety is complied with by following the directions provided here and observing all local operation & installation requirements at the intended location of use.

This product is completely safe when using any options and accessories supplied by the manufacturer of this product for use with it. Refer to Section 2 (Installation) of this manual for further details.

Pressure Safety

For this product to operate satisfactorily, pressurized gas must be connected to it. Observe all the information contained within this manual and all local operation & installation requirements at the intended location of use. Refer to Section 2 (Installation) of this manual for further details.

Hazardous Materials (WEEE, RoHS3 & REACH)

This product does not contain or release any prohibited chemicals listed on the SVHC (Substances of Very High Concern) Candidate List. During the intended normal operation of this product it is not possible for the user to come into contact with any hazardous materials. This product is designed to be recyclable except where indicated.

Safe Handling

Appropriate lifting and handling techniques should be used when moving and installing the ADG400.

- The total weight of the product is 23 kg (51 lb).
- Before commencing any lifting or handling, ensure that the intended location is suitable and is appropriately prepared.
- A clear path to the intended location should be made and appropriate lifting aids used (e.g. a suitably rated trolley).
- Due to the bulky nature and weight of the product, it is recommended that two people perform all handling operations.
- Be aware that saturators should be emptied of water before transporting the ADG400. See Section 4.4 for instructions.

Repair and Maintenance

The instrument must be maintained either by the manufacturer or an accredited service agent. For contact information, visit the website at www.michell.com.

Safety Conformity

This product meets the essential protection requirements of the relevant EU & UK directives. Further details of applied standards may be found in Appendix B.

Abbreviations

The following abbreviations are used in this manual:

barg	pressure unit (=100 kP or 0.987 atm) (bar gauge)
°C	degrees Celsius
°F	degrees Fahrenheit
DC	direct current
g	grams
in	inch(es)
µm	micrometer
m/sec	meters per second
mA	milliampere
mm	millimetres
MPa	megapascal
NI/min	normal liters per minute
Nm	Newton meter
oz	ounces
psig	pounds per square inch
RH	relative humidity
scfh	standard cubic feet per hour
fps	feet per second
T	temperature
V	Volts
Ω	Ohms
∅	diameter

1 INTRODUCTION

The ADG400 is designed for use as part of a hygrometry calibration system. It is capable of repeatable generation of dew points across a range of -80 °C...+20 °C, when used in conjunction with the Michell Instruments PSD2 pressure swing dryer.

The generator is based on the volumetric mixing of dry and wet gases. It gives the fastest response when changing between set points in comparison to other dew-point generator technologies (such as two-temperature, two-pressure or a combination of both).

The controller comes pre-programmed with a standard table of dew-point set points, from -80 °C to +20 °C at 10 °C intervals. The table contains flow rates for each of the 5 MFCs, along with solenoid settings that determine if 1 or 2 stage mixing is used. A user table is also provided allowing up to 13 user-defined setpoints to be stored.

There are 3 modes of operation: Manual mode for push-button selection of set-points, Profile mode for automatic timed changing of set-points, and Remote mode for changing of set-points via serial commands sent over the USB port for integration with customer software. Further to this, the ADG HMI can be displayed and interacted with on a PC connected via the USB interface.

The ADG400 is designed to be used in conjunction with a high accuracy reference instrument such as a Michell Instruments S8000 RS.

1.1 Features

The key features of the ADG include:

- Full-color touch-screen HMI
- 11-point factory-programmed dew-point setpoint table from -80 to +20 °C at 10 °C intervals
- 13-point user programmable dew-point setpoint table
- 3 programmable 13-point automatic calibration profiles with customizable timings
- Change set points using serial commands via built-in USB port
- Remote Access mode allows HMI to be operated using a connected PC
- Temperature-controlled enclosure to ensure output stability and repeatability

1.2 Theory of Operation

Dried air is supplied to the ADG – some of this dry air is used as-is for mixing, and some is diverted through the two saturators. Each saturator is filled with distilled or demineralized water, and the dry air stream is bubbled through this water via a sintered nozzle, which creates a stream of wet air that can be used for mixing. Each saturator is followed by a water trap which is necessary to prevent water from escaping the saturation system when it is pressurized/depressurized.

The first mixing stage comprises 3 high-precision mass-flow controllers. One MFC controls the dry air flow from the external dry air source. The other 2 MFCs give coarse and fine control of the wet air from the saturators. This stage enables dew points from +20 °C to -20 °C to be generated.

The second mixing stage comprises of 2 further MFCs. One MFC controls a flow of dry air from the external dry air source. The second MFC controls the flow of air from the first stage. This second mixing stage enables dew points from -30 to -80 °C.

2 INSTALLATION

2.1 Unpacking the Instrument

On delivery, please check that all the following standard components are in the packing box:

- ADG400 Dew-Point Generator
- IEC Power Cable
- USB-B Cable

2.2 Power Supply

The ADG400 is fitted with a switch-mode power supply that can accept mains power 90...264 V AC, 47...63 Hz via the IEC power connection.

The ADG400 is fitted with a 10 A 20 x 5 mm (T) fuse located behind a fuse cover next to the IEC power connection.

2.3 USB Connection

A USB type-B port is fitted to the back of the instrument to enable remote access to the HMI from a PC or changing set-points via serial commands.

Refer to *Section 3.6.3, Remote Mode*, and *Section 3.6.4, Remote Access*, for more information.

2.4 Dry Gas Supply

The generator requires a supply of high-quality (oil free) dry gas with a moisture content of $<0.5 \text{ ppm}_v$ ($<-80 \text{ }^\circ\text{C}$ atmospheric dew point) or compressed air to the same specification as used during its setup/calibration. This enables the maximum range of dew points to be generated.

A minimum flow of 7 NI/min (14.8 scfh) is required, delivered at a pressure of 2.0 barg (29.0 psig).

If replacing an existing dew-point generator connected to a PSD2, the internal pressure regulator of the PSD2 MUST be adjusted to 2.0 barg (29.0 psig), otherwise the ADG400 will not function. Refer to the latest PSD2 manual from the PST website (www.processsensing.com) for instructions on how to perform this adjustment.

The generator was set up/calibrated using either a Michell PSD2 Pressure Swing Dryer or a specific compressed air supply. A warning label, stipulating what the air inlet specification needs to comply with, appears on the rear panel of the generator.

WARNING!

COMPLY WITH AIR INLET SPECIFICATION
TO ENSURE ACCURATE OPERATION

Air Inlet Specification:

Pressure = 2.00 BarG (29 PsiG)

Dew Point = $-85 \text{ }^\circ\text{C}$ @ 1.013 BarA

2.5 Gas Connections

The gas inlet and outlet connections are Swagelok® 6 mm stainless-steel bulkhead union tube fittings, located on the rear panel of the unit marked **GAS IN** and **GAS OUT**.

2.6 Typical Setup

The ADG should be used in conjunction with a Michell Chilled Mirror Reference Instrument.

A complete system would usually include:

- Dry air source (Michell Instruments PSD2)
- ADG400 Generator
- Chilled Mirror Reference Instrument with flow control valve
- Manifold for units under test with flow control valve
- Bypass leg for venting excess flow with flow control valve

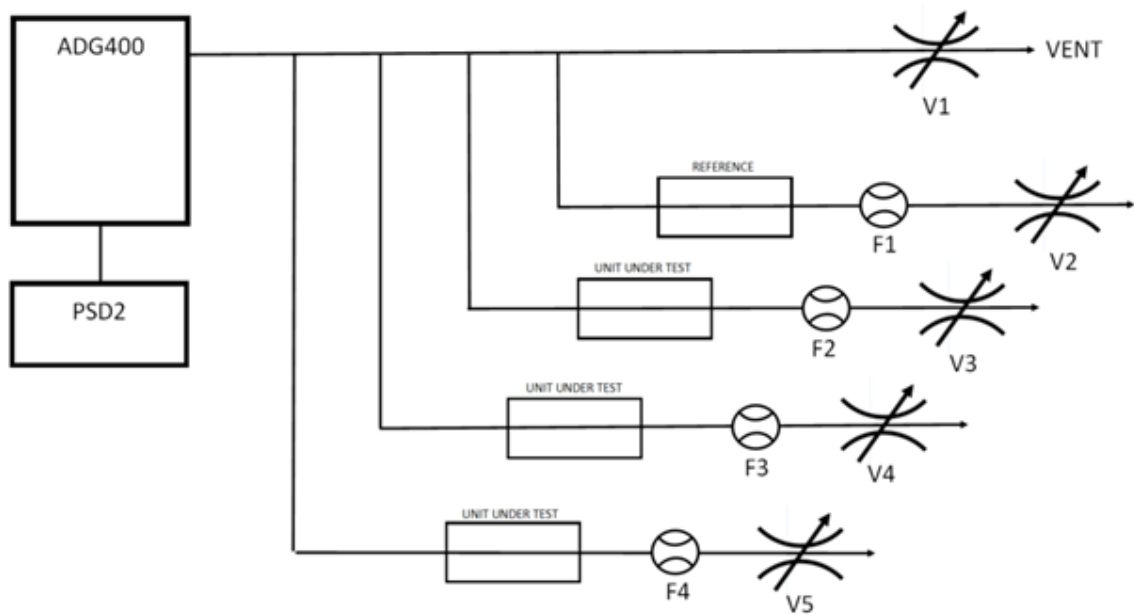

Figure 1 *Typical Setup Diagram*

3 OPERATION

It is recommended to familiarize yourself with the installation, operation and maintenance sections of this manual before using the product for the first time.

3.1 First-time Operation

Before using the instrument for the first time, the following steps should be taken.

1. Install the electrical and gas connections as per the instructions in *Section 2, Installation*.
2. Power-on the instrument.
3. Fill the saturators using the saturator filling mode – full instructions are given in *Section 3.6.10*.
4. It is recommended to leave the generator set to DRYER mode and run overnight before first use.

Note: The generator is designed to be operated continuously and does not need to be powered off. When not using the generator, it should be set to DRYER mode.

3.2 Typical Calibration Run

Dew-point calibrations should always run from the driest point to the wettest, with an adequate purge being carried out at the beginning to reduce the moisture level of the system, and all the units under test, to below the lowest point to be calibrated.

Prior to beginning a calibration, the following checks should be carried out:

1. Power-on the reference hygrometer.
2. Ensure all units under test are installed into calibration manifold and all unused manifold ports are blanked off.
3. Check the saturator level and top up, if required, by initiating the saturator filling mode.

A typical calibration to -80 °Cfp, for the Michell Instruments Easidew, would use the following timings:

Set Point (°C Dew/Frost Point)	Minimum Stabilization Time
DRYER	48 hours
-80	12 hours
-70	8 hours
-60	4 hours
-50	2 hours
-40	1 hour
-30	1 hour
-20	1 hour
-10	1 hour
0	1 hour
+10	1 hour
+20	1 hour

Table 1 *Minimum Stabilization Times*

3.3 HMI

The ADG uses a 3.5" full-color touch-screen controller.

3.4 Screensaver

When idle for 10 minutes, the display of the ADG will be set to screensaver mode, which dims the display. This helps to maintain the brightness of the backlight as the unit is constantly powered on.

The length of time before the screensaver is active is configurable in the settings menu.

3.5 Main Screen

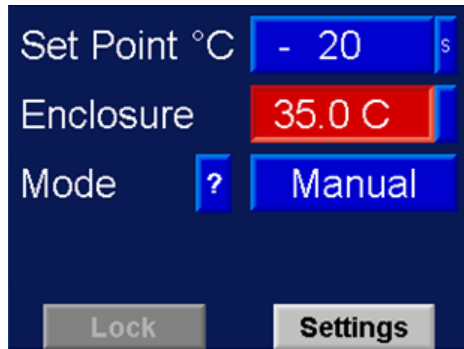

Figure 2 Manual Mode

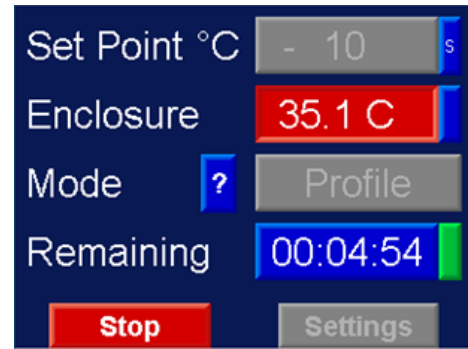

Figure 3 Profile Mode

Item	Description						
Set Point	<p>Indicates currently selected set point in all modes.</p> <p>The indicator to the far right shows if the selected set point is from:</p> <table border="1"> <tr> <td>S</td> <td>Standard Table</td> </tr> <tr> <td>U</td> <td>User Table</td> </tr> </table> <p>Pressing the button will bring up the Set Point selection screen in Manual mode.</p>	S	Standard Table	U	User Table		
S	Standard Table						
U	User Table						
Enclosure Temperature	Displays the current enclosure temperature, which should be at 35 °C ±0.1 °C						
? (Status Button)	<p>Displays the status screen.</p> <p>Note: Entering the status screen will pause a running profile, until un-paused by the user.</p>						
Mode	Only available in Manual mode; allows the mode of operation to be set to Profile or Remote.						
Remaining	<p>Shows the remaining time for the current profile set point in hh:mm:ss format. Press the time button to pause/un-pause the profile.</p> <p>Far-right indicator:</p> <table border="1"> <tr> <td>Green</td> <td>Profile running</td> </tr> <tr> <td>Yellow</td> <td>Profile paused</td> </tr> <tr> <td>Red</td> <td>Profile complete</td> </tr> </table>	Green	Profile running	Yellow	Profile paused	Red	Profile complete
Green	Profile running						
Yellow	Profile paused						
Red	Profile complete						
Lock	Only shown in Manual mode; locks the display with the fixed passcode.						
Stop	<p>Shown in Profile and Remote modes when a passcode is not set.</p> <p>Returns to Manual mode, retaining the current set point.</p>						
Unlock	<p>Requires a passcode to unlock the display.</p> <p>Returns to Manual mode, retaining the current set point.</p>						
Settings	Only enabled in Manual mode; navigates to the Settings menu.						

For information about locking the display with a passcode, refer to *Section 3.6.7, Settings Menu*.

3.6 Modes of Operation

The modes of operations are:

- **Manual mode:** change set points by button press
- **Profile mode:** set points change automatically after a predetermined time
- **Remote mode:** set points are changed by serial command from a PC (for software integration)
- **Remote Access:** the ADG is controlled from a PC using the HMI

When in Manual mode, the mode can be changed by pressing the **Mode** button.

When in Profile or Remote mode, the **Stop** button must be pressed to return to Manual mode. The **Stop** button will be replaced with an **Unlock** button if passcode protection is enabled.

3.6.1 Manual Mode

Pressing the **Set Point** button takes you to the set-point picker, enabling a new set point to be selected.

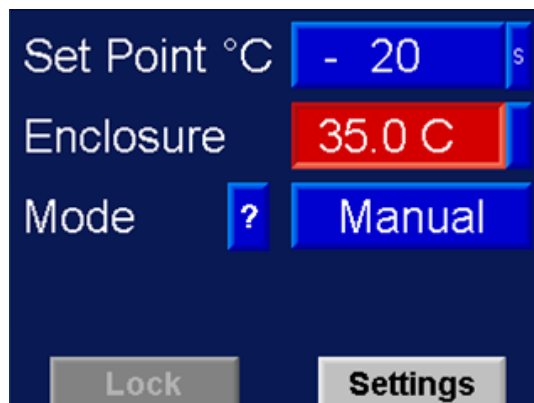
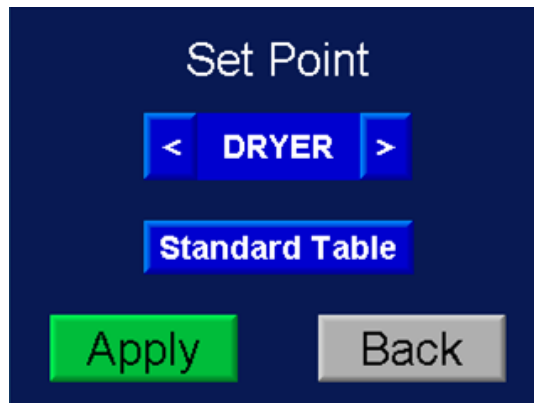

Figure 4 *Main Screen in Manual Mode*

3.6.1.1 Set Point Picker

This is used to change the set point in Manual mode.



Item	Description
Arrow Buttons < >	Change the desired set point.
Standard Table / User Table Button	Select a new set point from the displayed table. This is only visible if the user-defined set points have been created.
Apply	Apply the selected set point and return to the Main screen.
Back	Return to the Main screen without changing the set point.

Figure 5 Set Point Picker Screen

3.6.2 Profile Mode

Profile mode runs one of three profiles which contain a list of set points, each with an associated duration. This allows unattended operation.

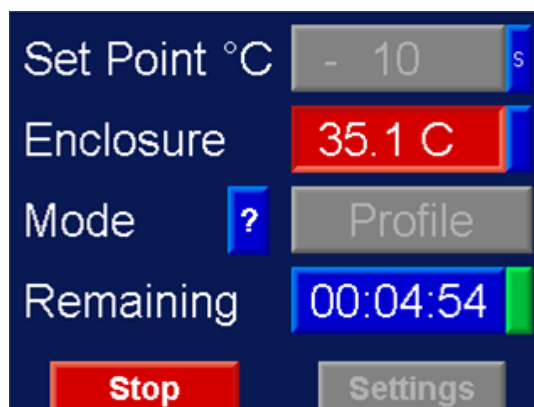

Figure 6 Main Screen in Profile Mode

To enter Profile mode, the **Mode** button is pressed from the Main screen. This takes you to the Profile select screen, which allows one of the three profile presets to be loaded.



Figure 7 *Profile Selection Screen*

Selecting one of the profile presets will start the profile and return to the Main screen.

Pressing the **Back** button will lead back to the Main screen, leaving the ADG in Manual mode.

Refer to *Section 3.6.9, Profile Editor*, for details on how to define calibration profiles.

3.6.3 Remote Mode

When connecting the ADG400 to a PC using the USB connection, it will appear as a virtual serial port.

In Remote mode, set points can be changed via a serial command. This mode is designed for integration with customer software. For remote control of the generator from a PC, please see also *Section 3.6.4, Remote Access*, which may be more appropriate, depending on the intended result.

In Remote mode, controls are disabled, including the **Read MFCs** button on the status page, which is disabled to ensure a remote set-point change event cannot be interrupted. The MFC **Set Point** and **Measure** values on the status page can only be updated using the appropriate serial command.

Note: This cannot be used in conjunction with Remote Access, which relies on the same serial port connection.

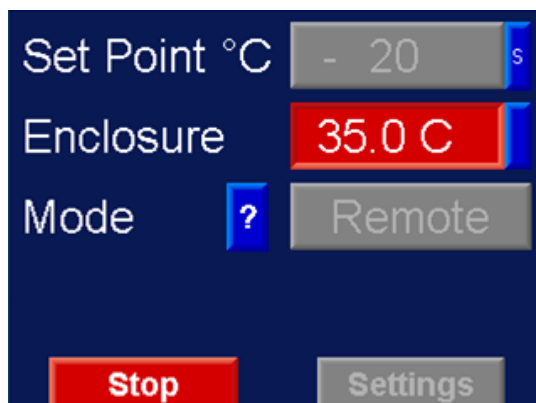

Figure 8 *Main Screen in Remote Mode*

3.6.3.1 Remote Mode Commands

The following commands are supported:

Command	Description
SPxx<cr>	Activate Set Point Index xx, where xx is a number from 00 to 13. Set point is loaded from the standard set point table.
UPxx<cr>	Activate Set Point Index xx, where xx is a number from 00 to 13. Set point is loaded from the user set point table.
READ<cr>	Returns the data string shown in the example below:

Table 2 Supported Serial Commands

READ command returned string:

I,5,S,0010,U,STD,SP,+06400+28800+00000+00000+00000,SP&MSR,+12801+12800+00000+00000+04000+04000+30720+30720+10559+10560,H,+350,EOM

Component	Description
I	
5	Set Point Index
S	
0010	Dew/Frost Point of Set Point (+10 °C)
U	
STD	Set Point Source Table (USR or STD)
SP	
+06400+28800+00000+00000+00000	Target MFC Values (S1Dry+S1Wet(C)+S1Wet(F)+S2Dry+S2Wet)
SP&MSR	
+12801+12800+00000+00000+04000+04000+30720+30720+10559+10560	Measured then Set Point Value for each MFC 12801 = S1Dry Measured 12800 = S1Dry Set-Point etc.
H	
+350	Enclosure Temperature * 10 (35 °C)
EOM	

Table 3 Read Command Response Explanation

Commands must be sent as a complete string and cannot be typed in letter by letter using a terminal program.

Please contact your PST representative for an example software project, showing how to implement the communications protocol.

3.6.4 Remote Access

The ADG can be controlled from a PC, providing full access to the user interface in a desktop window, as shown below. **Note:** this cannot be used in conjunction with Remote mode, which relies on the same serial port over USB connection.

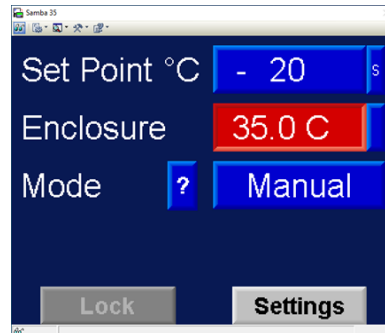
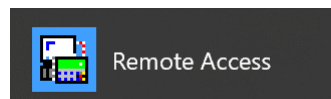

Figure 9 Main Screen Shown on a PC via Remote Access Software

3.6.5 Installing and Using the Remote Access Software

1. Navigate to the Michell Instruments software download page: <http://www.michell.com/uk/support/sware-downloads.php>
2. Download and install the ADG400 Remote Access package.
3. Restart the PC – this is essential, otherwise the software will not launch.
4. Launch the Remote Access software from the Start menu. It must be "Run as Administrator".

Note: You should first change the compatibility options for the shortcut to always "Run as Administrator": first, right click on the shortcut and select **Properties**, then navigate to the **Compatibility** tab.



5. Set the OPLC model to the Samba 35 through the configuration menu.

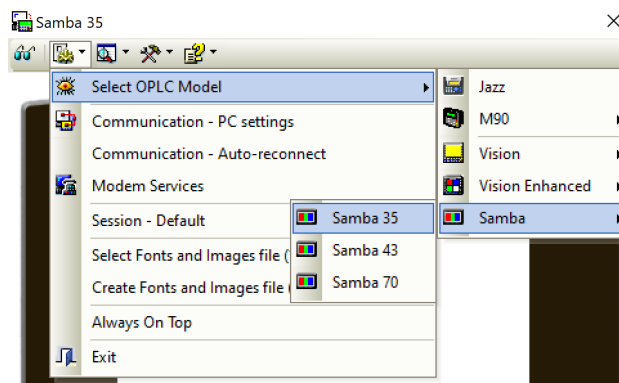

6. From the same menu, select **Communication – PC Settings** and change the "PC Port" to the appropriate COM port number for the ADG. This can be found in Device Manager, under **Ports**.
7. Click the **OnLine** button to connect to the ADG.

3.6.6 Status Page

Entering the status page will pause a running profile. This prevents a "Read MFCs" operation conflicting with an automatic change in set point.

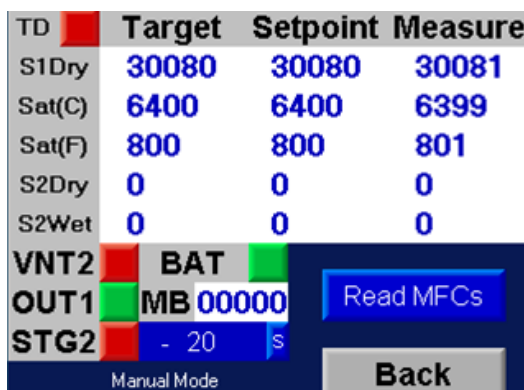

Item	Description
TD Indicator	Illuminated green when Transition Delay mode is active. A description of this feature follows this table.
Target Column	MFC Target values read from Standard/User calibration table
Set Point Column	MFC set-point values read back from the MFC. In most cases, these should match the Target values. In TD mode, S2Wet set point will read 0.
Measure Column	MFC measured flow values – these should generally be within ± 5 counts of the set point value.
VNT2	Indicates the current state of stage 2 selection solenoid. Should be illuminated green for all set points that use 2-stage mixing.
OUT1	Indicates the current state of stage 1 selection solenoid. Should be illuminated green for all set points that use 1-stage mixing.
STG2	Indicates the current state of stage 2 selection solenoid. Should be illuminated green for all set points that use 2-stage mixing.
BAT	Indicates the state of the memory back-up battery. In the event that this indicator turns red, contact the Michell UK service department for instructions on replacing the battery.
MB	MFC Modbus communications status indicator Indicates 00000 for good communication A 1 in any position indicates unsuccessful communication with the corresponding MFC.
Set Point Indicator	Shows currently selected set point
Read MFCs Button	Reads all MFCs to update the Set Point and Measure columns. In Remote mode, values can only be updated when requested by serial command, and this button is disabled. This means that sometimes values will be out of date. This is to prevent interruption of a Remote set-point change event.

Figure 10 Status Page Screen

3.6.6.1 Transition Delay

When changing from full dry (Dryer mode) to a 2-stage set point, there is a 2-minute delay before the MFC5 wet flow set point is selected to allow the upstream pipework to be purged. This is reflected by the target/set point of MFC5 on the status screen being set to 0, and the TD indicator being illuminated.

3.6.7 Settings Menu

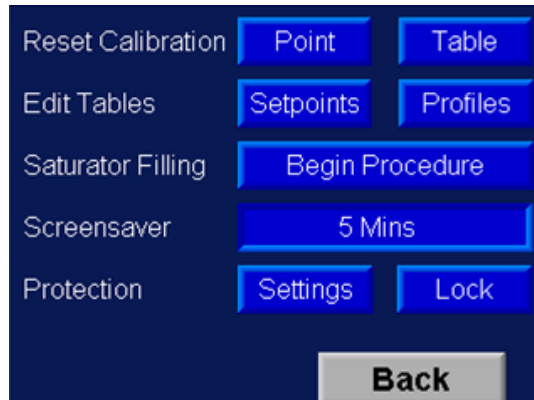

Item	Description
Reset Calibration	Restore either a single point or all of the Standard calibration table from the factory settings stored in flash memory.
Edit Tables	Launch either the Set Point Editor or Profile Editor.
Saturator Filling	Launch the guided saturator filling mode.
Screensaver	Time before enabling the screensaver.
Protection	Protect Settings menu or Main screen from tampering with a simple fixed passcode.
Back	Return to Main screen.

Figure 11 *Settings Screen*

3.6.8 Set Point Editor

The set point editor allows the factory set points to be adjusted, and new user set points to be defined.

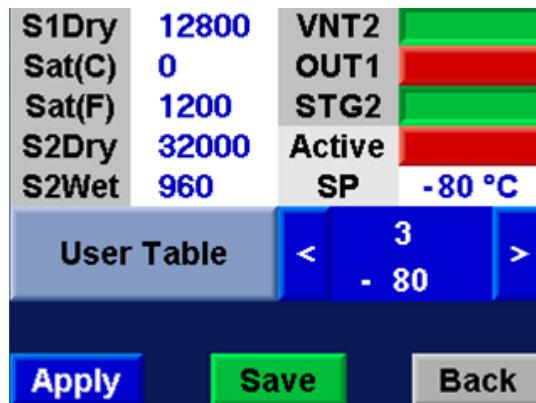

Item	Description
S1Dry	Stage 1 dry flow MFC
Sat(C)	Stage 1 wet flow MFC (coarse adjustment)
Sat(F)	Stage 1 wet flow MFC (fine adjustment)
S2Dry	Stage 2 dry flow MFC
S2Wet	Stage 2 wet flow from Stage 1 MFC
VNT2	Indicates the current state of stage 2 selection solenoid. Should be illuminated green for all setpoints that use 2-stage mixing.
OUT1	Indicates the current state of stage 1 selection solenoid. Should be illuminated green for all set points that use 1-stage mixing.
STG2	Indicates the current state of stage 2 selection solenoid. Should be illuminated green for all set points that use 2-stage mixing.

Figure 12 Set Point Editor Screen

Pressing the displayed MFC and SP values opens an editor window.

Pressing the **Solenoid** & **Active** buttons toggles the state.

3.6.8.1 Converting MFC Values to ml/min Flow Rates

MFC Name	Span (cc/min)
S1Dry	5000
Sat(C)	1000
Sat(F)	200
S2Dry	5000
S2Wet	200

Table 4 *Span of Installed MFCs*

MFC values are stored in the range of 0...32000.

At 0 the MFC is fully closed and will not let-by gas.

At 32000 the MFC is fully open and will be set to its maximum flow rate.

To calculate actual flow rate in cc/min, the following simple calculation is required:

$$\text{MFCVAL} = (\text{FLOW}/\text{SPAN}) * 32000$$

e.g. 1000 cc/min on S1Dry MFC which has a span of 5000 cc/min would be $(1000/5000)*32000 = 6400$

3.6.8.2 Adjusting Set Points

If it is necessary to make an adjustment to a set point because it no longer matches, follow the guidelines below:

- Make adjustments in small increments, waiting for the reference instrument to stabilize between adjustments.
- For 2-stage points, the primary adjustment should be made by modifying MFC5; at most points, +100 to +200 counts to MFC5 = +0.1 °C
- If you run out of adjustment on MFC5 (by hitting 200 ml/min max), then reduce MFC1 dry flow by 100 counts.
- To make adjustments to a 1-stage point, it should only be necessary to increase or decrease Sat(F) / Sat(C). The 0 °C point should be set to a value of +1 °C to make it easier to measure with a chilled mirror, as 0...-5 °C is difficult to measure with a chilled mirror.
- The +20 °C point should be set to a value of +18 °C to reduce condensation risk in colder environments.
- MFC flow rate must be within zero/span range (640...32000) for reliable operation. Minimum saturator flow of 80 ml/min (12800) should be set, except for the -80 °C point. MFC1 + MFC5 maximum total flow must not be more than 7 L/min
- Target flow rate is 5000 ±100 ml min for all points, decreasing to approx. 4 L/min at +1 °C, 2 L/min at +10 °C and 1 L/min.

3.6.9 Profile Editor

The profile editor allows automatic calibration profiles to be defined.

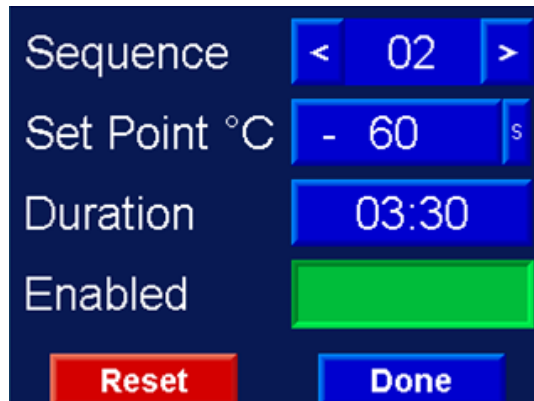

Item	Description
Sequence Arrows	Changes between profile points Saves current profile point settings
Set point	Opens the set-point picker to select a set point from a user or standard table
Duration	Opens the keypad to set duration
Enabled	When disabled, point is skipped in profile
Reset	Resets the entire profile to default durations/set points
Done	Saves the current profile point settings

Figure 13 *Profile Editor Screen*

3.6.10 Saturator Filling Mode

It is necessary to use the saturator filling mode when adding water to the saturators.

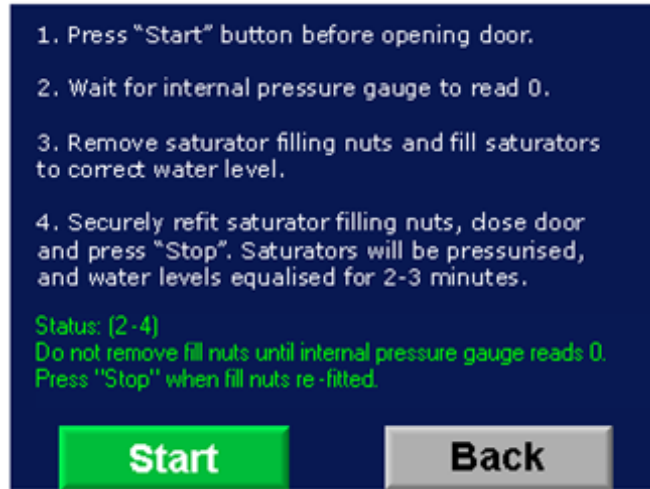

Item	Description
Start	Begin de-pressurization of saturators and water traps to allow them to be filled.
Stop	Begin re-pressurization of saturators and water traps after filling.
Back	Returns to the settings screen

Figure 14 Saturator Filling Screen

To fill the saturators, follow the on-screen instructions. Both saturators must be filled for proper operation, although water is consumed by the first saturator at a faster rate. The water level in both the saturator and its associated water trap should be considered as per the below diagram.

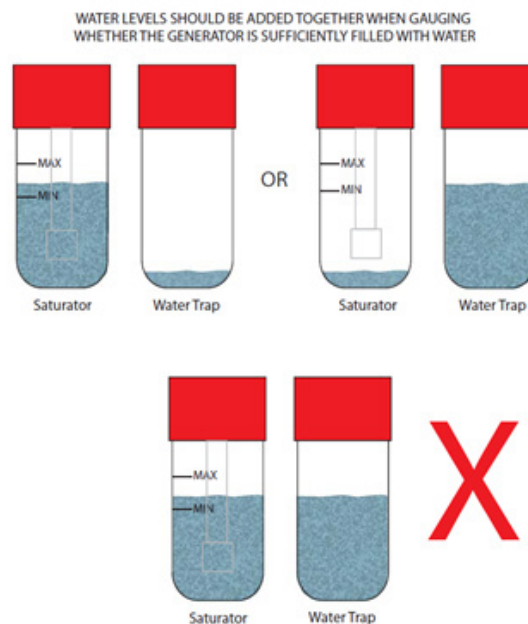

Figure 15 Saturator Fill Levels

3.6.10.1 Saturator Filling Instructions

1. Press the **Start Filling** button before opening the door.
2. Wait for the internal BPR pressure gauge to read 0.
3. Remove the saturator filling nuts and fill saturators to the correct water level.
4. Securely refit the saturator filling nuts, close the door and press **Stop Filling**.
5. The saturators will be pressurized and water levels equalized over a period of 2...3 minutes.

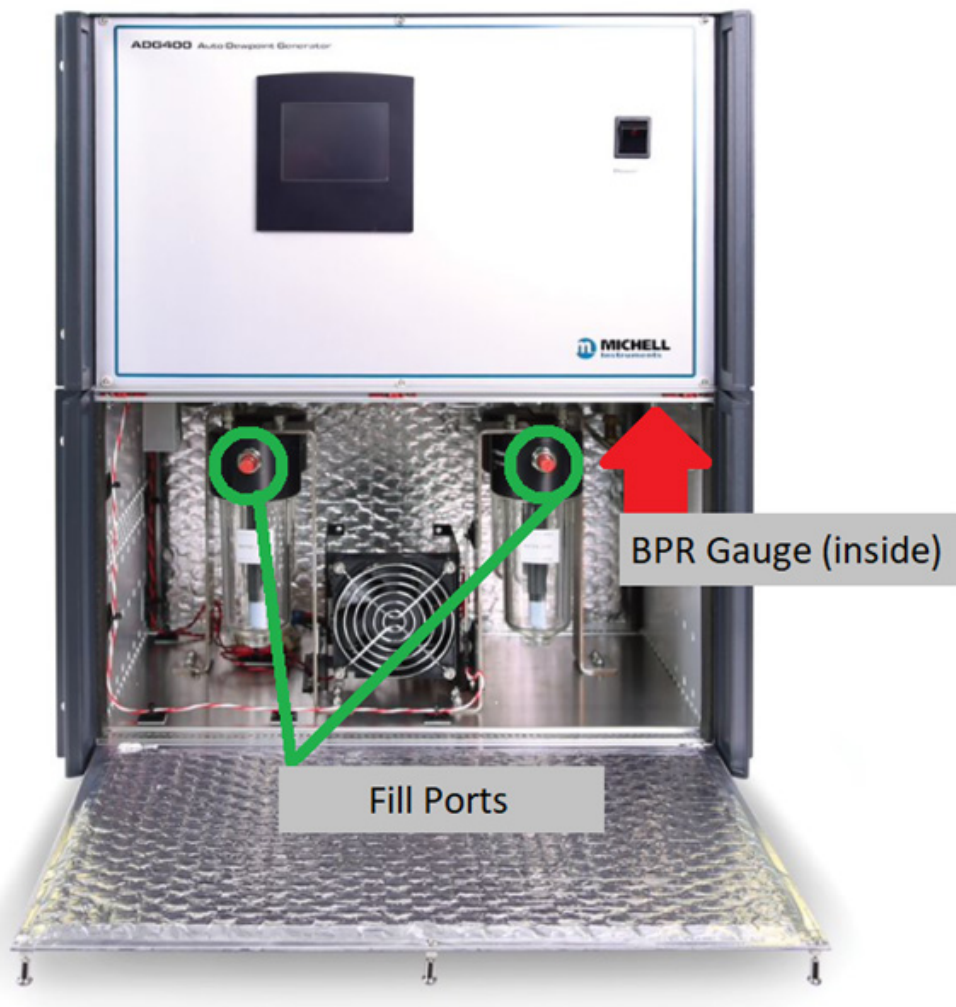

Figure 16 ADG400 with Open Front Panel

4 MAINTENANCE

Maintenance must only be carried out by a trained electrical and pressure-competent engineer. Before commencing any maintenance operations:

1. Isolate the gas supply.
2. Completely depressurize the saturators and internal pipework.
3. Isolate the power supply.

After maintenance:

1. Restore the gas supply.
2. Restore the power supply.
3. Run the saturator filling procedure.

If in any doubt, return the complete unit to Michell Instruments, or an authorized distributor, for repair.

4.1 Inlet Particulate Filter

The filter element is designed to capture any dust in the inlet air from the connected desiccant dryer. A replacement interval of 5 years is recommended. Michell part number GEN-96031.

4.2 Fuses

There is an external 10 A 20 x 5 mm (T) 10 A fuse fitted to the AC mains input above the IEC socket.

There is an internal 16 A (T) 20 x 5 mm fuse fitted to protect only the 24 V DC heater circuit.

There is an internal 4.5 A (T) 20 x 5 mm fuse fitted to protect all other 24 V DC components.

4.3 General Troubleshooting

Symptom	Action
Power switches on, but the screen is off/dim	The screensaver is running – touch the screen.
Saturators not bubbling Water spread between water trap and saturators	Run the saturator filling procedure to equalize the pressure in the saturators.
Output is too dry	Check the water level. Check the saturators as above.
Enclosure does not heat to 35 °C set point	Check the fan is spinning Check the heater fuse; if blown, a heater element may have failed – measure the resistance of each heater element and contact Michell support.
Fan does not spin but unit otherwise OK	Contact Michell support for a replacement fan.
On HMI, only ? status menu is available; all other functions are unavailable	Contact Michell support.
PLC BAT indicator is RED on the status screen	Contact Michell support for battery replacement instructions.

4.4 Emptying the Saturators for Transport

Before transportation, the saturators must be emptied of water.

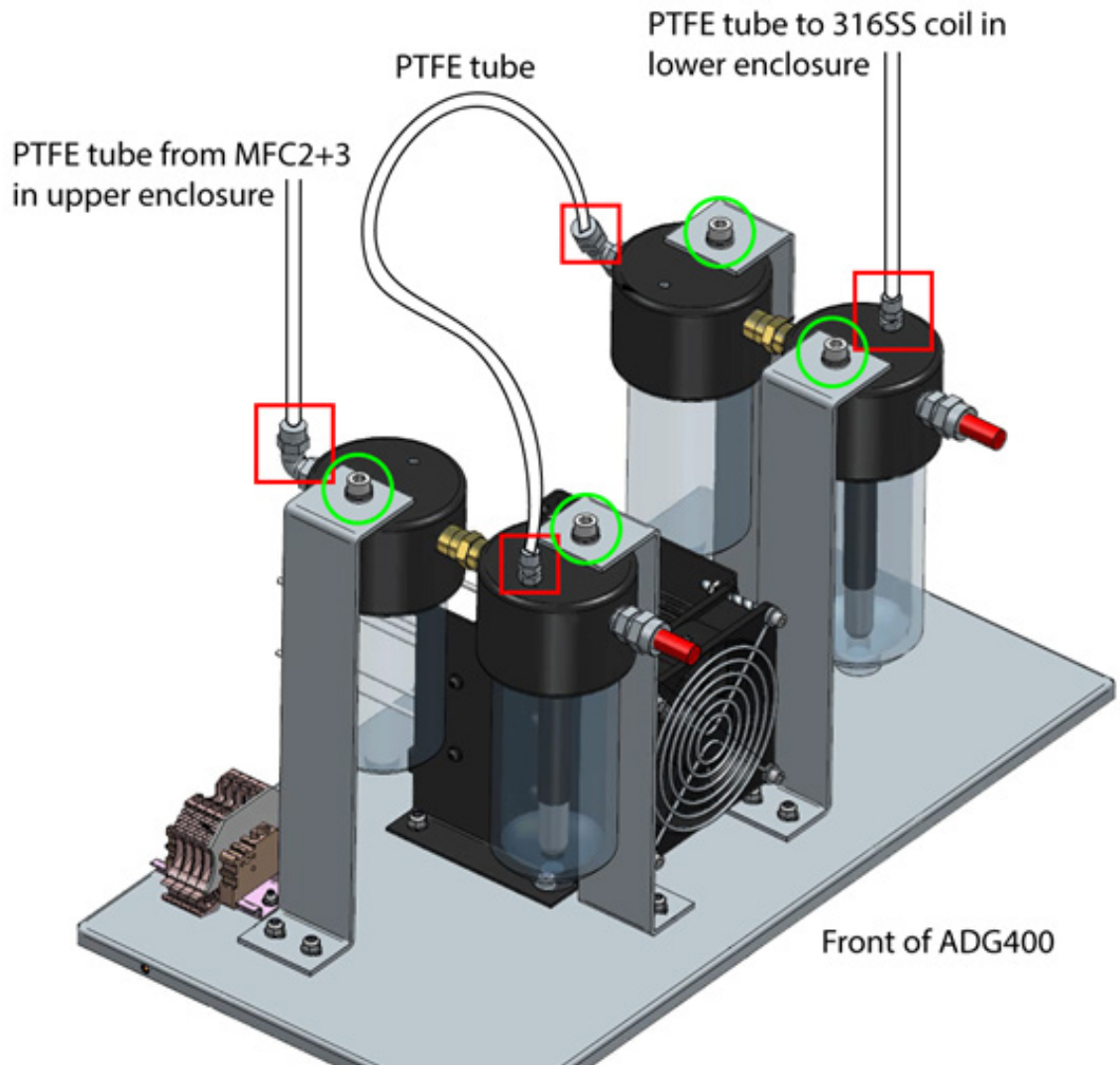

Figure 17 *ADG400 Internal View*

1. Switch off the ADG400.
2. Open the front panel.
3. Wait until the BPR gauge reads 0 barg (0 psig) and the saturators stop bubbling before proceeding.
4. Disconnect the PTFE connections highlighted in red.
5. Remove the bolts highlighted in green.
6. Unscrew the transparent plastic bowls from the saturators and dispose of the water.
7. Re-assemble by following the previous steps in reverse.

Appendix A

Technical Specifications

Appendix A Technical Specifications

Performance	
Output Range	-80...+20 °C dew point
Output Stability	< 0.05 °C
Repeatability	< 0.5 °C
HMI	Full-color touch screen
Set Points	11-point factory setup set-point table @ 10 °C intervals. 13-point user configurable set-point table
Operating Modes	Manual, Timed Profile, Remote Command
Electrical Specifications	
Digital Communications	USB (Virtual Serial Port) for remote operation of HMI via a PC, or changing set points via remote commands
Power Supply	IEC Socket 80...264 V AC (47...63 Hz) or 113...370 V DC
Power Consumption	400 VA Max.
Operating Specifications	
Operating Temperature	23 °C ±3 °C (73.4 °F ±5.4 °F)
Storage Temperature	5 °C...50 °C (41 °F...122 °F)
Gas Input Requirements	Compressed air from PSD2 Pressure Swing Dryer, set-up with ADG400 as matched pair
Gas Input Pressure	2.0 barg (29.0 psig)
Gas Input Flow Rate	7 NI/min
Gas Input Moisture Content	< 0.4 ppm _v
Gas Output Flow Rate	5 NI/min from -80 °C to -10 °C frost point, 4 NI/min at 1 °C decreasing to 1 NI/min at +20 °C dew point
Mechanical Specifications	
Enclosure	Painted Aluminum
Dimensions	19" Subrack, 12U Height, ~360 mm Depth
Filtration	Inlet particulate filter
Gas Connections	6 mm Swagelok® Tube
Weight	23 kg

A.1 Dimensions

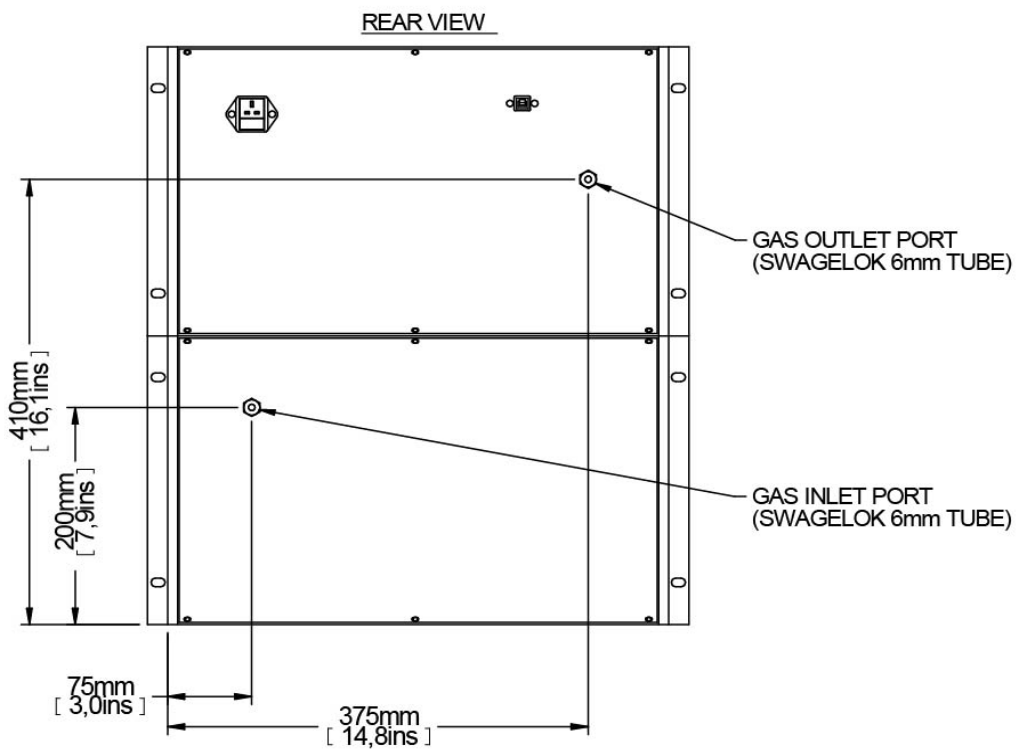
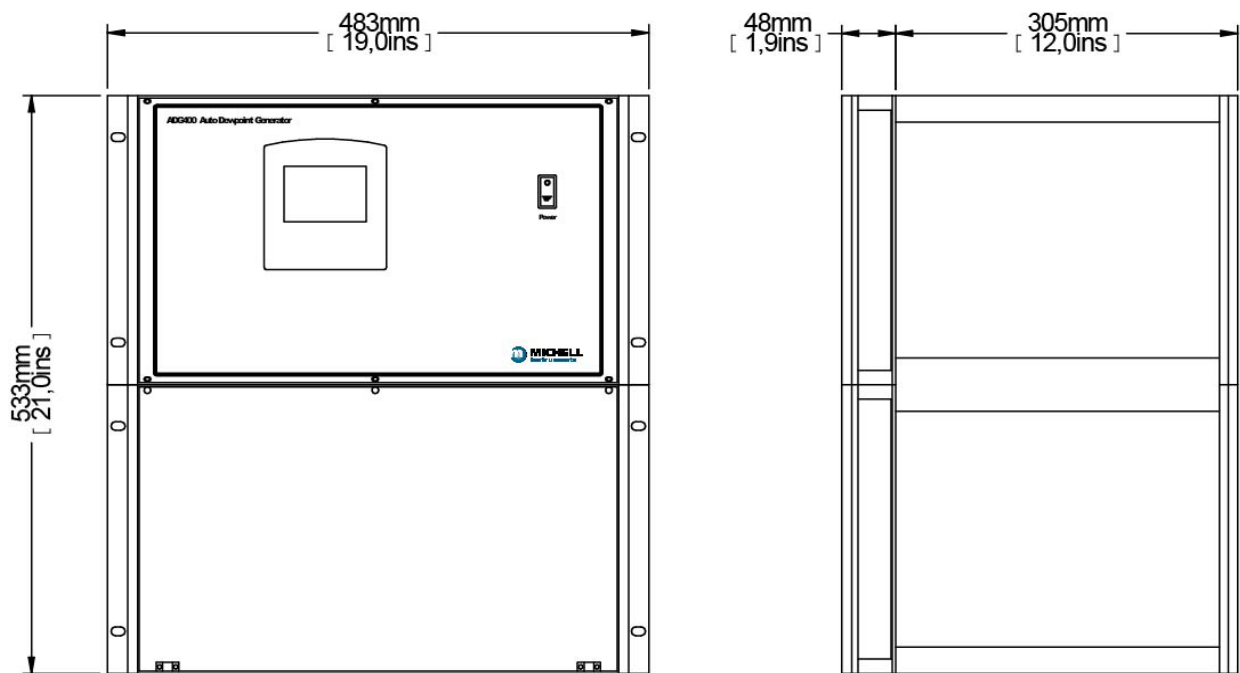

Appendix B

Quality, Recycling, Compliance & Warranty Information

Appendix B Quality, Recycling, Compliance & Warranty Information

Michell Instruments is dedicated to complying to all relevant legislation and directives. Full information can be found on our website at:

www.michell.com/compliance

This page contains information on the following directives:

- Anti-Facilitation of Tax Evasion Policy
- ATEX Directive
- Calibration Facilities
- Conflict Minerals
- FCC Statement
- Manufacturing Quality
- Modern Slavery Statement
- Pressure Equipment Directive
- REACH
- RoHS3
- WEEE2
- Recycling Policy
- Warranty and Returns

This information is also available in PDF format.

Appendix C

Return Document & Decontamination Declaration

Appendix C Return Document & Decontamination Declaration

Decontamination Certificate

IMPORTANT NOTE: Please complete this form prior to this instrument, or any components, leaving your site and being returned to us, or, where applicable, prior to any work being carried out by a Michell engineer at your site.

Instrument			Serial Number	
Warranty Repair?	YES	NO	Original PO #	
Company Name			Contact Name	
Address				
Telephone #			E-mail address	
Reason for Return /Description of Fault:				
Has this equipment been exposed (internally or externally) to any of the following? Please circle (YES/NO) as applicable and provide details below				
Biohazards			YES	NO
Biological agents			YES	NO
Hazardous chemicals			YES	NO
Radioactive substances			YES	NO
Other hazards			YES	NO
Please provide details of any hazardous materials used with this equipment as indicated above (use continuation sheet if necessary)				
Your method of cleaning/decontamination				
Has the equipment been cleaned and decontaminated?			YES	NOT NECESSARY
Michell Instruments will not accept instruments that have been exposed to toxins, radio-activity or bio-hazardous materials. For most applications involving solvents, acidic, basic, flammable or toxic gases a simple purge with dry gas (dew point <-30°C) over 24 hours should be sufficient to decontaminate the unit prior to return. Work will not be carried out on any unit that does not have a completed decontamination declaration.				
Decontamination Declaration				
I declare that the information above is true and complete to the best of my knowledge, and it is safe for Michell personnel to service or repair the returned instrument.				
Name (Print)			Position	
Signature			Date	



Instrument Expert
Original factory
packaging
www.keruiyiqi.cn

www.ProcessSensing.com



<http://www.michell.com>