

OX-A431 Oxidising Gas Sensor – Ozone + Nitrogen Dioxide – 4-Electrode

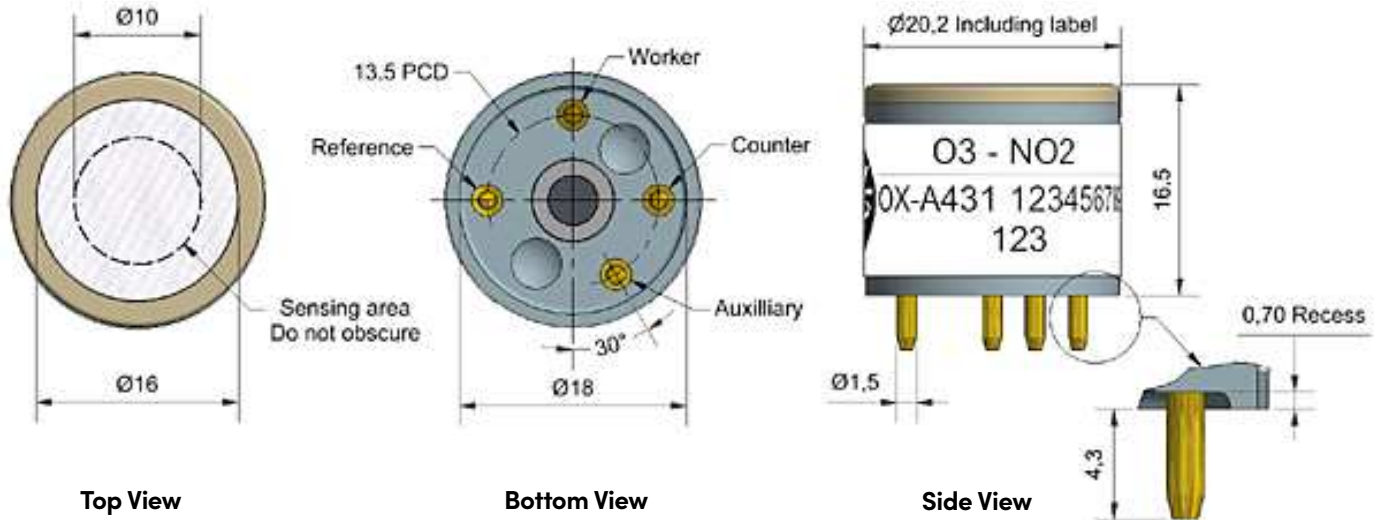

Dimensions are in millimetres (± 0.15 mm).

Specification O₃ Sensing

Performance			
Sensitivity	nA/ppm at 1ppm O ₃		-200 to -650
Response time	t90 (s) from zero to 1ppm O ₃		< 80
Zero current	nA in zero air at 20°C		-70 to +70
Noise*	± 2 standard deviations (ppb equivalent)		15
Range	ppm O ₃ limit of performance warranty		20
Linearity	ppm error at full scale, linear at zero and 20ppm O ₃		< ± 0.5
Overgas limit	maximum ppm for stable response to gas pulse		50
*Tested with Alphasense AFE low noise circuit			

Lifetime			
Zero drift	ppb equivalent change/year in lab air		0 to 20
Sensitivity drift	% change/year in lab air, monthly test		< -20 to -40
Operating life	months until 50% original signal (24-month warranted)		> 24

Environmental			
Sensitivity @ -20°C	% (output @ -20°C/output @ 20°C) @ 2ppm O ₃		60 to 80
Sensitivity @ 40°C	% (output @ 40°C/output @ 20°C) @ 2ppm O ₃		80 to 105
Zero @ -20°C	nA		0 to 25
Zero @ 40°C	nA		20 to 90

Cross Sensitivity					
H ₂ S	sensitivity	% measured gas @ 5ppm	H ₂ S		< -80
NO	sensitivity	% measured gas @ 5ppm	NO		< 5
Cl ₂	sensitivity	% measured gas @ 5ppm	Cl ₂		< 100
SO ₂	sensitivity	% measured gas @ 5ppm	SO ₂		< -3
CO	sensitivity	% measured gas @ 5ppm	CO		< -3
C ₂ H ₄	sensitivity	% measured gas @ 100ppm	C ₂ H ₄		< 0.1
NH ₃	sensitivity	% measured gas @ 20ppm	NH ₃		< 0.1
H ₂	sensitivity	% measured gas @ 100ppm	H ₂		< 0.1
CO ₂	sensitivity	% measured gas @ 5% volume	CO ₂		< 0.1
Halothane	sensitivity	% measured gas @ 100ppm	Halothane		< 0.1

Key Specifications			
Temperature range	°C		-30 to 40
Pressure range	kPa		80 to 120
Humidity range	% rh continuous		15 to 85
Storage period	months @ 3 to 20°C (stored in sealed pot)		6
Load resistor	Ω (AFE circuit is recommended)		33 to 100
Weight	g		< 6

Figure 1 Sensitivity Temperature Dependence To 1ppm O₃

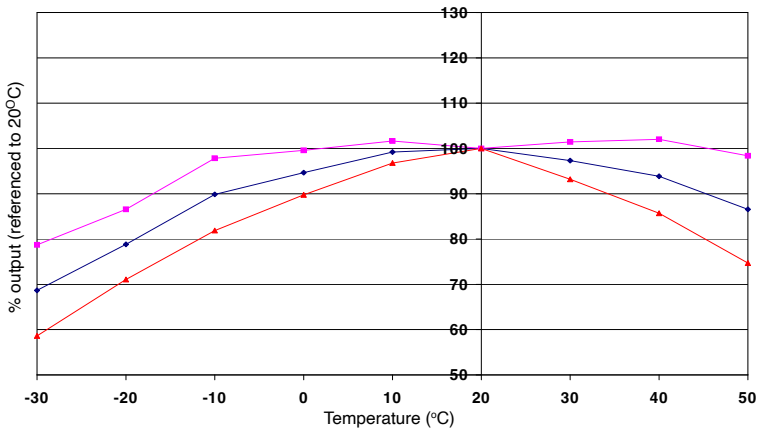

Figure 1 shows the mean and 95% confidence levels for the temperature dependence of sensitivity at 1ppm O₃.
Measuring Ozone at higher temperatures requires good casing design to ensure the Ozone reaches the sensor before reacting.
This data is taken from a typical batch of sensors.

Figure 2 Zero Temperature Dependence

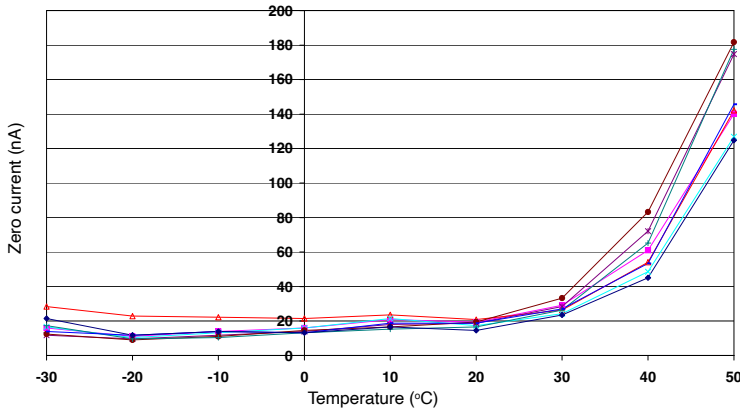

Figure 2 shows the variation in zero output of the working electrode caused by changes in temperature, expressed as nA.
This data is taken from a typical batch of sensors.
Contact Alphasense for further information on zero current correction.

Figure 3 Response from 200ppb to 0ppb O₃

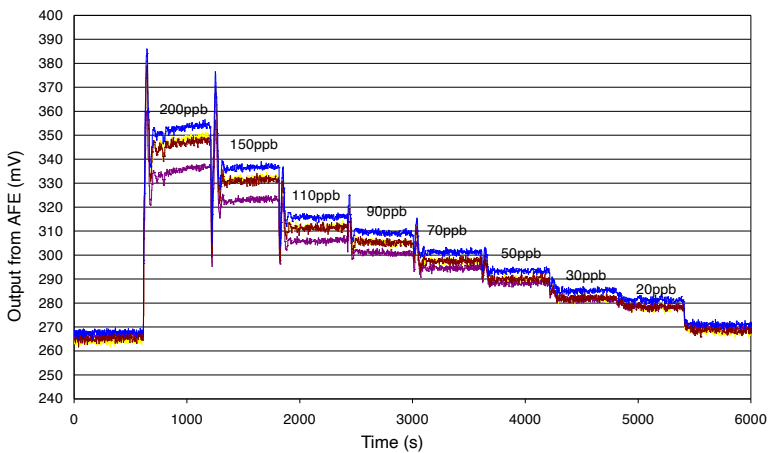

Figure 3 shows response from 200ppb O₃ to 0ppb O₃.
Use of Alphasense AFE circuit reduces noise to 15ppb, with the opportunity of digital smoothing to reduce noise even further.
Offset voltage is due to intentional AFE circuit electronic offset.

The OX-A431 detects both ozone and nitrogen dioxide (O₃ +NO₂). The NO2-A43F measures only nitrogen dioxide, filtering out ozone. Using these sensors together allows you to calculate the O₃ concentration by subtracting the corrected NO2-A43F concentration from the corrected OX-A431 concentration.

Before subtracting to determine ozone concentration, ensure that the signals from the two sensors have been corrected for electronic zero offset, sensor zero offset and temperature dependence, and sensitivity (nA/ppm) calibration and temperature dependence.

Specification NO₂ Sensing

Performance	Sensitivity to NO ₂	nA/ppm at 2ppm NO ₂	-200 to -550		
	Response time	t90 (s) from zero to 1ppm NO ₂	< 80		
	Zero current	nA in zero air at 20°C	-70 to +70		
	Noise*	±2 standard deviations (ppb equivalent)	15		
	Range	ppm NO ₂ limit of performance warranty	20		
	Linearity	ppm error at full scale, linear at zero and 20ppm NO ₂	< ± 0.5		
	Overgas limit	maximum ppm for stable response to gas pulse	50		
	*Tested with Alphasense AFE low noise circuit				
Lifetime	Zero drift	ppb equivalent change/year in lab air	0 to 20		
	Sensitivity drift	% change/year in lab air, monthly test	< -20 to -40		
	Operating life	months until 50% original signal (24-month warranted)	> 24		
Environmental	Sensitivity @ -20°C	% (output @ -20°C/output @ 20°C) @ 2ppm NO ₂	50 to 80		
	Sensitivity @ 40°C	% (output @ 50°C/output @ 20°C) @ 2ppm NO ₂	115 to 130		
	Zero @ -20°C	nA	0 to 25		
	Zero @ 40°C	nA	20 to 50		
Cross Sensitivity	H ₂ S	sensitivity	% measured gas @ 5ppm	H ₂ S	< -100
	NO	sensitivity	% measured gas @ 5ppm	NO	< 5
	Cl ₂	sensitivity	% measured gas @ 5ppm	Cl ₂	< 100
	SO ₂	sensitivity	% measured gas @ 5ppm	SO ₂	< -3
	CO	sensitivity	% measured gas @ 5ppm	CO	< -3
	C ₂ H ₄	sensitivity	% measured gas @ 100ppm	C ₂ H ₄	< 0.1
	NH ₃	sensitivity	% measured gas @ 20ppm	NH ₃	< 0.1
	H ₂	sensitivity	% measured gas @ 100ppm	H ₂	< 0.1
	CO ₂	sensitivity	% measured gas @ 5% volume	CO ₂	0.1
Halothane	sensitivity	% measured gas @ 100ppm	Halothane	< 0.1	
Key Specifications	Temperature range	°C	-30 to 40		
	Pressure range	kPa	80 to 120		
	Humidity range	% rh continuous	15 to 85		

Figure 4 Sensitivity temperature dependence to 2ppm NO₂

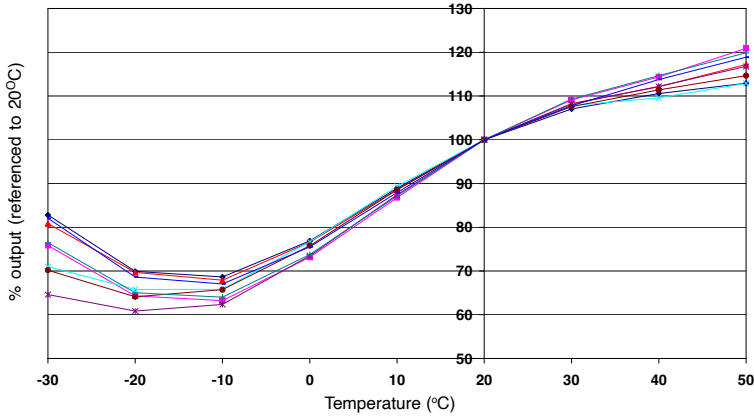
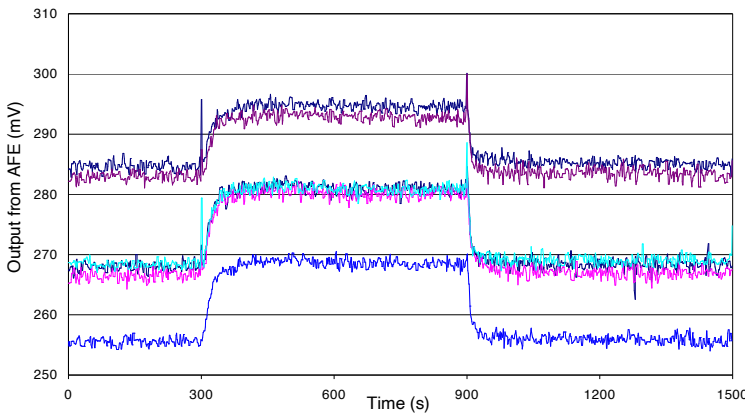

Figure 4 shows the temperature dependence of sensitivity at 2ppm NO₂.
This data is taken from a typical batch of sensors.

Figure 5 Response to 50ppb NO₂



The OX-A431 shows fast response and return to baseline, even at low concentrations.

Figure 6 Response from 200ppb to 0ppb NO₂

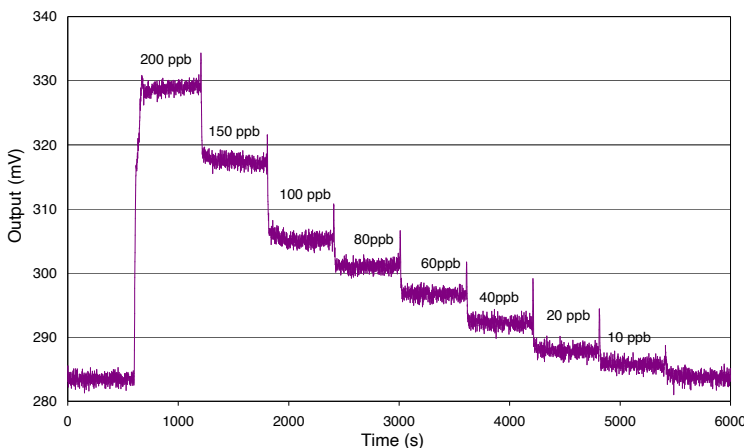

Figure 6 shows response from 200ppb NO₂ to 0ppb NO₂.
Use of Alphasense AFE circuit reduces noise to 15ppb, with the opportunity of digital smoothing to reduce noise even further.
Offset voltage is due to intentional AFE circuit electronic offset.

NOTE: All sensors are tested at ambient environmental conditions, with 47 ohm load resistor, unless otherwise stated. As applications of use are outside our control, the information provided is given without legal responsibility. Customers should test under their own conditions, to ensure that the sensors are suitable for their own requirements.

At the end of the product's life, do not dispose of any electronic sensor, component or instrument in the domestic waste, but contact the instrument manufacturer, Alphasense or its distributor for disposal instructions. NOTE: all sensors are tested at ambient environmental conditions unless otherwise stated. As applications of use are outside our control, the information provided is given without legal responsibility. Customers should test under their own conditions, to ensure that the sensors are suitable for their own requirements.

In the interest of continued product improvement, we reserve the right to change design features and specifications without prior notification. The data contained in this document is for guidance only. Alphasense Ltd accepts no liability for any consequential losses, injury or damage resulting from the use of this document or the information contained within. (©ALPHASENSE LTD) Doc. Ref. OX-A431/SEP22